

Lamp

Contents

1 Lamp (electrical component)	1
1.1 Types	1
1.2 Uses other than illumination	2
1.3 Lamp circuit symbols	2
1.4 See also	2
1.5 References	2
2 Incandescent light bulb	3
2.1 History	3
2.1.1 Early pre-commercial research	4
2.1.2 Commercialization	5
2.2 Tungsten bulbs	6
2.3 Efficacy, efficiency, and environmental impact	8
2.3.1 Cost of lighting	9
2.3.2 Measures to ban use	9
2.3.3 Efforts to improve efficiency	9
2.4 Construction	10
2.4.1 Gas fill	10
2.5 Manufacturing	11
2.6 Filament	12
2.6.1 Coiled coil filament	12
2.6.2 Reducing filament evaporation	12
2.6.3 Bulb blackening	13
2.6.4 Halogen lamps	13
2.6.5 Incandescent arc lamps	14
2.7 Electrical characteristics	14
2.7.1 Power	14
2.7.2 Current and resistance	14
2.8 Physical characteristics	14
2.8.1 Bulb shapes	14
2.8.2 Lamp bases	15
2.9 Light output and lifetime	16
2.10 See also	17

2.11	References	17
2.12	External links	20
3	Halogen lamp	21
3.1	History	21
3.2	Halogen cycle	22
3.3	Effect of voltage on performance	22
3.4	Spectrum	23
3.5	Safety	23
3.5.1	Handling precautions	23
3.6	Applications	24
3.6.1	Automotive	24
3.6.2	Architectural	24
3.6.3	Cooking	24
3.6.4	Home use	24
3.6.5	Stage lighting	24
3.6.6	Specialized	24
3.7	Disposal	25
3.8	External links	25
3.9	See also	25
3.10	References	25
4	Fused quartz	26
4.1	Production	26
4.1.1	Feedstock	26
4.1.2	Fusion	26
4.1.3	Product quality	26
4.2	Applications	26
4.2.1	Refractory material applications	27
4.3	Physical properties	27
4.4	Optical properties	28
4.5	Typical properties of clear fused silica	28
4.6	See also	28
4.7	References	28
4.8	External links	29
5	LED lamp	30
5.1	Technology overview	31
5.2	Application	31
5.3	Household LED lamps	32
5.3.1	Replacement for existing lighting	32
5.3.2	Lighting designed for LEDs	33

5.4	Specialty uses	33
5.5	Comparison to other lighting technologies	33
5.5.1	Energy Star qualification	34
5.6	Limitations	34
5.6.1	Efficiency droop	35
5.7	Development and adoption history	35
5.7.1	Examples of early adoption	36
5.8	See also	36
5.9	References	36
5.10	Further reading	38
5.11	External links	38
6	Light-emitting diode	39
6.1	History	40
6.1.1	Discoveries and early devices	40
6.1.2	Initial commercial development	41
6.1.3	The blue and white LED	41
6.1.4	Illumination breakthrough	41
6.2	Working	42
6.3	Technology	42
6.3.1	Physics	42
6.3.2	Refractive index	43
6.3.3	Efficiency and operational parameters	43
6.3.4	Lifetime and failure	44
6.4	Colors and materials	45
6.4.1	RGB	45
6.4.2	Ultraviolet and blue LEDs	45
6.4.3	White light	46
6.4.4	Organic light-emitting diodes (OLEDs)	48
6.4.5	Quantum dot LEDs	49
6.5	Types	49
6.5.1	Miniature	49
6.5.2	Mid-range	50
6.5.3	High-power	50
6.5.4	AC driven LED	50
6.5.5	Application-specific variations	51
6.6	Considerations for use	51
6.6.1	Power sources	51
6.6.2	Electrical polarity	52
6.6.3	Safety and health	52
6.6.4	Advantages	52
6.6.5	Disadvantages	53

6.7	Applications	53
6.7.1	Indicators and signs	54
6.7.2	Lighting	54
6.7.3	Data communication and other signaling	55
6.7.4	Sustainable lighting	56
6.7.5	Light sources for machine vision systems	56
6.7.6	Other applications	57
6.8	See also	57
6.9	References	58
6.10	Further reading	63
6.11	External links	63
7	Arc lamp	64
7.1	Operation	64
7.2	Carbon arc lamp	65
7.3	History	66
7.3.1	Carbon-arc lighting in the U.S.	66
7.4	See also	67
7.5	References	68
7.6	Bibliography	68
7.7	External links	68
8	Xenon arc lamp	69
8.1	Types	69
8.2	History and modern usage	69
8.3	Lamp construction	70
8.4	Light generation mechanism	70
8.5	Ceramic xenon lamps	71
8.6	Power supply requirements	71
8.7	Automotive headlamps	72
8.8	Xenon long-arc-lamps	72
8.9	See also	72
8.10	References	72
8.11	External links	72
9	Ultra-high-performance lamp	73
9.1	Known manufacturers of high pressure discharge lamps (UHP or similar)	73
9.2	Devices using UHP lamps	73
9.3	References	73
9.4	References	73
9.5	External links	73
10	Metal-halide lamp	75

10.1	Uses	75
10.2	Operation	76
10.3	Components	76
10.3.1	Arc tube	76
10.3.2	Outer bulb	77
10.3.3	Base	77
10.3.4	Ballasts	77
10.4	Color temperature	78
10.5	Starting and warm up	78
10.6	End of life behaviour	78
10.6.1	Risk of lamp explosion	79
10.7	Other safety concerns	79
10.7.1	Eyes	79
10.8	ANSI ballast codes	79
10.9	See also	79
10.10	References	80
10.11	Further reading	80
11	Gas-discharge lamp	81
11.1	History	81
11.2	Color	82
11.3	Types	82
11.3.1	Low pressure discharge lamps	82
11.3.2	High pressure discharge lamps	83
11.3.3	High-intensity discharge lamps	83
11.4	Other examples	83
11.5	See also	84
11.6	References	84
11.7	Further reading	84
11.8	External links	84
12	Fluorescent lamp	85
12.1	History	86
12.1.1	Physical discoveries	86
12.1.2	Early discharge lamps	86
12.1.3	Neon lamps	88
12.1.4	Commercialization of fluorescent lamps	88
12.2	Principles of operation	89
12.2.1	Construction	89
12.2.2	Electrical aspects of operation	90
12.2.3	Effect of temperature	91
12.2.4	Losses	91

12.2.5	Cold cathode lamps	92
12.2.6	Starting	92
12.2.7	End of life	96
12.3	Phosphors and the spectrum of emitted light	97
12.3.1	Color temperature	98
12.3.2	Color rendering index	98
12.3.3	Phosphor composition	99
12.4	Applications	99
12.5	Advantages	99
12.5.1	Luminous efficacy	99
12.5.2	Life	99
12.5.3	Lower luminance	99
12.5.4	Lower heat	99
12.6	Disadvantages	100
12.6.1	Frequent switching	100
12.6.2	Health and safety issues	100
12.6.3	Ultraviolet emission	100
12.6.4	Ballast	100
12.6.5	Power quality and radio interference	100
12.6.6	Operating temperature	101
12.6.7	Lamp shape	101
12.6.8	Flicker problems	101
12.6.9	Dimming	102
12.6.10	Disposal and recycling	102
12.7	Lamp sizes and designations	102
12.8	Other fluorescent lamps	102
12.9	Science demonstrations	103
12.10	See also	103
12.11	References	103
12.12	Further reading	105
12.13	External links	105
13	Electric discharge	106
13.1	Applications	106
13.2	Natural phenomena	106
13.3	See also	106
14	Plasma (physics)	108
14.1	Properties and parameters	108
14.1.1	Definition	108
14.1.2	Ranges of parameters	109
14.1.3	Degree of ionization	109

14.1.4	Temperatures	109
14.1.5	Plasma potential	110
14.1.6	Magnetization	110
14.1.7	Comparison of plasma and gas phases	110
14.2	Common plasmas	111
14.3	Complex plasma phenomena	111
14.3.1	Filamentation	111
14.3.2	Shocks or double layers	112
14.3.3	Electric fields and circuits	112
14.3.4	Cellular structure	112
14.3.5	Critical ionization velocity	112
14.3.6	Ultracold plasma	112
14.3.7	Non-neutral plasma	112
14.3.8	Dusty plasma/grain plasma	112
14.3.9	Impermeable plasma	112
14.4	Mathematical descriptions	113
14.4.1	Fluid model	113
14.4.2	Kinetic model	113
14.5	Artificial plasmas	113
14.5.1	Generation of artificial plasma	114
14.5.2	Examples of industrial/commercial plasma	115
14.6	History	115
14.7	Fields of active research	116
14.8	See also	116
14.9	Notes	116
14.10	References	116
14.11	External links	118
15	Compact fluorescent lamp	120
15.1	History	121
15.2	Design	121
15.3	Characteristics	122
15.3.1	Spectrum of light	122
15.3.2	Lifespan	123
15.3.3	Energy efficiency	123
15.3.4	Cost	124
15.3.5	Failure	124
15.3.6	Dimming	124
15.3.7	Power factor	125
15.3.8	Infrared signals	125
15.3.9	Outdoor use	126
15.3.10	Starting time	126

15.4	Health and environmental impact	126
15.4.1	General	126
15.4.2	Mercury content	127
15.4.3	Recycling	127
15.4.4	Greenhouse gases	128
15.5	Use and adoption	128
15.6	Other CFL and lighting technologies	129
15.6.1	LEDs	129
15.7	Cold-cathode fluorescent lamps	129
15.8	Efficiency comparison	129
15.9	References	129
15.10	External links	132
16	Neon lamp	133
16.1	History	133
16.2	Description	133
16.3	Applications	134
16.3.1	Colour	135
16.3.2	Latching	136
16.4	See also	136
16.5	References	136
17	Mercury-vapor lamp	138
17.1	Origins	139
17.2	Principle of operation	139
17.2.1	Metal halide	139
17.2.2	Self-ballasted (SB) lamps	140
17.3	Operation	140
17.3.1	Color considerations	140
17.3.2	Emission line spectrum	141
17.4	Usage of low-pressure lamps for surface cleaning	141
17.5	Light pollution considerations	141
17.6	Bans	141
17.7	Ultraviolet hazards	141
17.8	End of life	142
17.9	Uses	142
17.9.1	Photoresist exposure	142
17.9.2	Area and street lighting	142
17.9.3	Molecular spectroscopy	142
17.10	See also	142
17.11	References	142
17.12	Further reading	143

18 Sodium-vapor lamp	144
18.1 Low-pressure sodium	144
18.1.1 Light pollution considerations	145
18.1.2 Film special effects	145
18.2 High-pressure sodium	145
18.2.1 “White” SON	147
18.2.2 Theory of operation	147
18.3 End of life	147
18.4 ANSI HPS ballast codes	148
18.5 See also	148
18.6 Notes	148
18.7 References	149
19 Sulfur lamp	150
19.1 Mechanism	150
19.2 Quality of emitted light	150
19.3 History	151
19.4 Electromagnetic interference	151
19.5 Environmental issues	151
19.6 Light distribution systems	151
19.6.1 Light pipes	151
19.6.2 Secondary reflectors	152
19.6.3 Indirect lighting	152
19.6.4 Direct lighting	152
19.6.5 Optical fibers	152
19.7 Other uses	152
19.8 Future prospects	153
19.9 Prominent installations	153
19.10 See also	153
19.11 Notes	153
19.12 Further reading	154
20 Electrodeless lamp	155
20.1 History	155
20.2 Plasma lamps	156
20.3 Magnetic induction lamps	157
20.3.1 Advantages	158
20.3.2 Disadvantages	159
20.4 See also	159
20.5 References	159
20.6 External links	159

21 Electric light	160
21.1 Types	160
21.1.1 Incandescent light bulb	160
21.1.2 Fluorescent lamp	161
21.1.3 LED lamp	161
21.1.4 Carbon arc lamp	162
21.1.5 Discharge lamp	162
21.2 Lamp life expectancy	162
21.3 Public lighting	162
21.4 See also	163
21.5 References	163
22 OLED	164
22.1 History	164
22.2 Working principle	165
22.3 Material technologies	166
22.3.1 Small molecules	166
22.3.2 Polymer light-emitting diodes	167
22.3.3 Phosphorescent materials	167
22.4 Device architectures	168
22.4.1 Structure	168
22.4.2 Patterning technologies	168
22.4.3 Backplane technologies	168
22.4.4 Fabrication	169
22.5 Advantages	169
22.6 Disadvantages	170
22.7 Manufacturers and commercial uses	171
22.7.1 Fashion	172
22.7.2 Samsung applications	172
22.7.3 Sony applications	173
22.7.4 LG applications	173
22.7.5 Mitsubishi applications	174
22.7.6 Recom Group/video name tag applications	174
22.7.7 BMW	174
22.8 Research	174
22.9 See also	174
22.10References	174
22.11Further reading	179
22.12External links	179
23 Solid-state lighting	180
23.1 Industry-wide Effects of Solid-state Lighting	180

23.2 See also	180
23.3 References	181
23.4 Further reading	181
23.5 External links	181
24 AMOLED	182
24.1 Design	182
24.2 Future development	182
24.3 Comparison to other technologies	183
24.4 Marketing terms	183
24.4.1 Super AMOLED	183
24.4.2 Super AMOLED Advanced	183
24.4.3 Super AMOLED Plus	183
24.4.4 HD Super AMOLED	184
24.4.5 HD Super AMOLED Plus	184
24.4.6 Full HD Super AMOLED	184
24.4.7 Quad HD Super AMOLED	184
24.4.8 Future	184
24.4.9 Comparison	185
24.5 Uses	185
24.6 References	187
24.7 External links	188
25 Light-emitting electrochemical cell	189
25.1 History	189
25.2 See also	189
25.3 References	189
26 Electroluminescent wire	191
26.1 Structure	191
26.2 Sequencers	192
26.2.1 Applications	192
26.3 References	192
26.4 External links	192
27 Field-induced polymer electroluminescent technology	193
27.1 See also	193
27.2 Notes	193
27.3 Text and image sources, contributors, and licenses	194
27.3.1 Text	194
27.3.2 Images	204
27.3.3 Content license	215

Chapter 1

Lamp (electrical component)

“Electric lamp” and “Light bulb” redirect here. For the item of furniture, see light fixture. For the music by Fujiya & Miyagi, see Lightbulbs (album).

A **lamp** is a replaceable component that produces light



Various compact fluorescent (CFL) lightbulbs

from electricity.^[1] Compact lamps are commonly called **light bulbs**, for example the incandescent light bulb. Lamps usually have a base made of ceramic, metal, glass or plastic, which secures the lamp in the socket of a light fixture. The electrical connection to the socket may be made with a screw-thread base, two metal pins, two metal caps or a bayonet cap.

1.1 Types

There are several types of lamp:

- Incandescent lamp, a heated filament inside a glass envelope
 - Halogen lamps use a fused quartz envelope, filled with halogen gas
- LED lamp, a solid-state lamp that uses light-emitting diodes (LEDs) as the source of light
- Arc lamp
 - Xenon arc lamp
- Mercury-xenon arc lamp
- Ultra-high-performance lamp, an ultra-high-pressure mercury-vapor arc lamp for use in projectors
- Metal-halide lamp
- Gas-discharge lamp, a light source that generates light by sending an electrical discharge through an ionized gas
 - Fluorescent lamp
 - Compact fluorescent lamp, a fluorescent lamp designed to replace an incandescent



A clear glass 60 W Neolux light bulb

lamp

- Neon lamp
- Mercury-vapor lamp
- Sodium-vapor lamp
- Sulfur lamp
- Electrodeless lamp, a gas discharge lamp in which the power is transferred from outside the bulb to inside via electromagnetic fields

1.2 Uses other than illumination

Lamps can be used as heat sources, for example in incubators and toys such as the Easy-Bake Oven.

Filament lamps have long been used as fast acting thermistors in electronic circuits. The filaments are most likely made out of tungsten. Popular uses have included:

- Stabilisation of sine wave oscillators
- Protection of tweeters
- Automatic volume control in telephones

1.3 Lamp circuit symbols

In circuit diagrams lamps usually are shown as symbols. There are two main types of symbols, these are:

1.4 See also

- Electric light
- Light source
- Light tube
- List of light sources

1.5 References

- [1] "Lamp". *Dictionary.com*. Retrieved Nov 9, 2014.

Chapter 2

Incandescent light bulb



A 230-volt incandescent light bulb, with a 'medium' sized E27 (Edison 27 mm) male screw base. The filament is visible as the horizontal line between the vertical supply wires.

An **incandescent light bulb**, **incandescent lamp** or **incandescent light globe** is an electric light which produces light with a wire filament heated to a high temperature by an electric current passing through it, until it glows (see Incandescence). The hot filament is protected from oxidation with a glass or quartz bulb that is filled with inert gas or evacuated. In a **halogen lamp**, filament evaporation is prevented by a chemical process that redeposits metal vapor onto the filament, extending its life. The light bulb is supplied with electrical current by feed-through terminals or wires embedded in the glass. Most bulbs are used

in a socket which provides mechanical support and electrical connections.

Incandescent bulbs are manufactured in a wide range of sizes, light output, and voltage ratings, from 1.5 volts to about 300 volts. They require no external regulating equipment, have low manufacturing costs, and work equally well on either alternating current or direct current. As a result, the incandescent lamp is widely used in household and commercial lighting, for portable lighting such as table lamps, car headlamps, and flashlights, and for decorative and advertising lighting.

Incandescent bulbs are much less efficient than most other types of electric lighting; incandescent bulbs convert less than 5% of the energy they use into visible light^[1] (with the remaining energy being converted into heat). The luminous efficacy of a typical incandescent bulb is 16 lumens per watt, compared to the 60 lm/W of a compact fluorescent bulb. Some applications of the incandescent bulb deliberately use the heat generated by the filament. Such applications include incubators, brooding boxes for poultry,^[2] heat lights for reptile tanks,^[3] infrared heating for industrial heating and drying processes, lava lamps, and the Easy-Bake Oven toy. Incandescent bulbs typically have short lifetimes compared with other types of lighting; around 1,000 hours for home light bulbs versus typically 10,000 hours for compact fluorescents and 30,000 hours for lighting LEDs.

Incandescent bulbs are gradually being replaced in many applications by other types of electric light, such as fluorescent lamps, compact fluorescent lamps (CFL), cold cathode fluorescent lamps (CCFL), high-intensity discharge lamps, and light-emitting diode lamps (LED). Some jurisdictions, such as the European Union, China, Canada and United States, are in the process of phasing out the use of incandescent light bulbs while others, including Colombia,^[4] Mexico, Cuba, Argentina, Brazil or Australia,^[5] have prohibited them already.

2.1 History

In addressing the question of who invented the incandescent lamp, historians Robert Friedel and Paul Israel^[6] list

22 inventors of incandescent lamps prior to Joseph Swan and Thomas Edison. They conclude that Edison's version was able to outstrip the others because of a combination of three factors: an effective incandescent material, a higher vacuum than others were able to achieve (by use of the Sprengel pump) and a high resistance that made power distribution from a centralized source economically viable.

Historian Thomas Hughes has attributed Edison's success to his development of an entire, integrated system of electric lighting.

The lamp was a small component in his system of electric lighting, and no more critical to its effective functioning than the Edison Jumbo generator, the Edison main and feeder, and the parallel-distribution system. Other inventors with generators and incandescent lamps, and with comparable ingenuity and excellence, have long been forgotten because their creators did not preside over their introduction in a system of lighting.

—Thomas P. Hughes, In *Technology at the Turning Point*, edited by W. B. Pickett^{[7][8]}

2.1.1 Early pre-commercial research

In 1802, Humphry Davy had what was then the most powerful electrical battery in the world at the Royal Institution of Great Britain (with the possible exception of another one made in the same year by Vasily Petrov in Russia). In that year, Davy created the first incandescent light by passing the current through a thin strip of platinum, chosen because the metal had an extremely high melting point. It was not bright enough nor did it last long enough to be practical, but it was the precedent behind the efforts of scores of experimenters over the next 75 years.^[10]

Over the first three-quarters of the 19th century many experimenters worked with various combinations of platinum or iridium wires, carbon rods, and evacuated or semi-evacuated enclosures. Many of these devices were demonstrated and some were patented.^[11]

In 1835, James Bowman Lindsay demonstrated a constant electric light at a public meeting in Dundee, Scotland. He stated that he could “read a book at a distance of one and a half feet”. However, having perfected the device to his own satisfaction, he turned to the problem of wireless telegraphy and did not develop the electric light any further. His claims are not well documented, although he is credited in *Challoner et al.* with being the inventor of the “Incandescent Light Bulb”.^[12]

In 1840, British scientist Warren de la Rue enclosed a coiled platinum filament in a vacuum tube and passed an electric current through it. The design was based on the concept that the high melting point of platinum would al-



Original carbon-filament bulb from Thomas Edison's shop in Menlo Park

low it to operate at high temperatures and that the evacuated chamber would contain fewer gas molecules to react with the platinum, improving its longevity. Although a workable design, the cost of the platinum made it impractical for commercial use.

In 1841, Frederick de Moleyns of England was granted the first patent for an incandescent lamp, with a design using platinum wires contained within a vacuum bulb.^[13]

In 1845, American John W. Starr acquired a patent for his incandescent light bulb involving the use of carbon filaments.^{[14][15]} He died shortly after obtaining the patent, and his invention was never produced commercially. Little else is known about him.^[16]

In 1851, Jean Eugène Robert-Houdin publicly demonstrated incandescent light bulbs on his estate in Blois, France. His light bulbs are on display in the museum of the Château de Blois.^[17]

In 1872, Russian Alexander Lodygin invented an incandescent light bulb and obtained a Russian patent in 1874. He used as a burner two carbon rods of diminished section in a glass receiver, hermetically sealed, and filled with nitrogen, electrically arranged so that the current could be passed to the second carbon when the first had been consumed.^[18] Later he lived in the USA, changed his name to Alexander de Lodyguine and applied and obtained patents for incandescent lamps having chromium,

iridium, rhodium, ruthenium, osmium, molybdenum and tungsten filaments,^[19] and a bulb using a molybdenum filament was demonstrated at the world fair of 1900 in Paris.^[20]

Heinrich Göbel in 1893 claimed he had designed the first incandescent light bulb in 1854, with a thin carbonized bamboo filament of high resistance, platinum lead-in wires in an all-glass envelope, and a high vacuum. Judges of four courts raised doubts about the alleged Göbel anticipation, but there was never a decision in a final hearing due to the expiry date of Edison's patent. A research work published 2007 concluded that the story of the Göbel lamps in the 1850s is a legend.^[21] On 24 July 1874, a Canadian patent was filed by Henry Woodward and Mathew Evans for a lamp consisting of carbon rods mounted in a nitrogen-filled glass cylinder. They were unsuccessful at commercializing their lamp, and sold rights to their patent (U.S. Patent 0,181,613) to Thomas Edison in 1879.^{[22][23]}

2.1.2 Commercialization

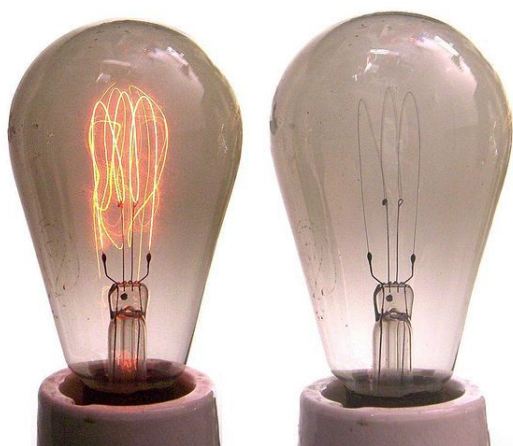

Carbon filament lamps, showing darkening of bulb

Joseph Swan (1828–1914) was a British physicist and chemist. In 1850, he began working with carbonized paper filaments in an evacuated glass bulb. By 1860, he was able to demonstrate a working device but the lack of a good vacuum and an adequate supply of electricity resulted in a short lifetime for the bulb and an inefficient source of light. By the mid-1870s better pumps became available, and Swan returned to his experiments.

With the help of Charles Stearn, an expert on vacuum pumps, in 1878, Swan developed a method of processing that avoided the early bulb blackening. This received a British Patent in 1880.^[24] On 18 December 1878, a lamp using a slender carbon rod was shown at a meeting of the Newcastle Chemical Society, and Swan gave a working demonstration at their meeting on 17 January 1879. It was also shown to 700 who attended a meeting of



Sir Joseph Wilson Swan

the Literary and Philosophical Society of Newcastle upon Tyne on 3 February 1879. These lamps used a carbon rod from an arc lamp rather than a slender filament. Thus they had low resistance and required very large conductors to supply the necessary current, so they were not commercially practical, although they did furnish a demonstration of the possibilities of incandescent lighting with relatively high vacuum, a carbon conductor, and platinum lead-in wires. Besides requiring too much current for a central station electric system to be practical, they had a very short lifetime.^[25] Swan turned his attention to producing a better carbon filament and the means of attaching its ends. He devised a method of treating cotton to produce 'parchmentised thread' and obtained British Patent 4933 in 1880.^[24] From this year he began installing light bulbs in homes and landmarks in England. His house was the first in the world to be lit by a lightbulb and so the first house in the world to be lit by hydroelectric power. In 1878 the home of Lord Armstrong at Cragside was also among the first houses to be lit by electricity. In the early 1880s he had started his company.^[26] In 1881, the Savoy Theatre in the City of Westminster, London was lit by Swan incandescent lightbulbs, which was the first theatre, and the first public building in the world, to be lit entirely by electricity.^[27]

Thomas Edison began serious research into developing a practical incandescent lamp in 1878. Edison filed his first patent application for "Improvement In Electric Lights" on 14 October 1878.^[28] After many experiments, first

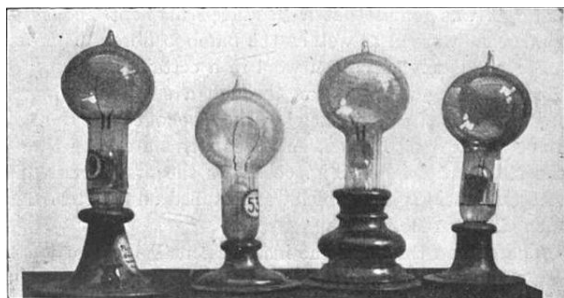

Edison carbon filament lamps, early 1880s

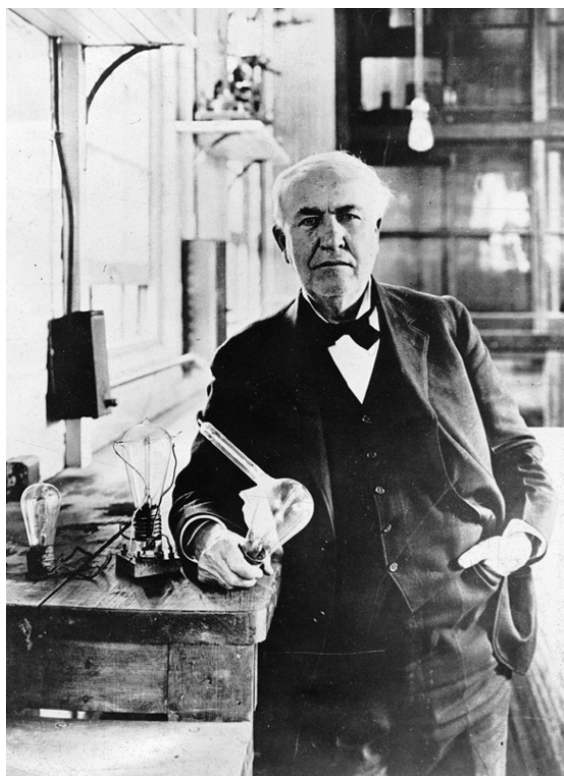

Thomas Alva Edison

with carbon in the early 1880s and then with platinum and other metals, in the end Edison returned to a carbon filament.^[29] The first successful test was on 22 October 1879,^{[30][31]} and lasted 13.5 hours. Edison continued to improve this design and by 4 November 1879, filed for a US patent for an electric lamp using “a carbon filament or strip coiled and connected ... to platina contact wires.”^[32] Although the patent described several ways of creating the carbon filament including using “cotton and linen thread, wood splints, papers coiled in various ways,”^[32] Edison and his team later discovered that a carbonized bamboo filament could last more than 1200 hours.^[33] In 1880, the Oregon Railroad and Navigation Company steamer, *Columbia*, became the first application for Edison’s incandescent electric lamps (it was also the first ship to execute use of a dynamo).^{[34][35][36]}

Hiram S. Maxim started a lightbulb company in 1878 to exploit his patents and those of William Sawyer. His

United States Electric Lighting Company was the second company, after Edison, to sell practical incandescent electric lamps. They made their first commercial installation of incandescent lamps at the Mercantile Safe Deposit Company in New York City in the fall of 1880, about six months after the Edison incandescent lamps had been installed on the *Columbia*. In October 1880, Maxim patented a method of coating carbon filaments with hydrocarbons to extend their life.

Lewis Latimer, employed at the time by Edison, developed an improved method of heat-treating carbon filaments which reduced breakage and allowed them to be molded into novel shapes, such as the characteristic “M” shape of Maxim filaments. On 17 January 1882, Latimer received a patent for the “Process of Manufacturing Carbons”, an improved method for the production of light bulb filaments, which was purchased by the United States Electric Light Company.^[37] Latimer patented other improvements such as a better way of attaching filaments to their wire supports.^[38]

In Britain, the Edison and Swan companies merged into the Edison and Swan United Electric Company (later known as Ediswan, and ultimately incorporated into Thorn Lighting Ltd). Edison was initially against this combination, but after Swan sued him and won, Edison was eventually forced to cooperate, and the merger was made. Eventually, Edison acquired all of Swan’s interest in the company. Swan sold his US patent rights to the Brush Electric Company in June 1882.

The United States Patent Office gave a ruling 8 October 1883, that Edison’s patents were based on the prior art of William Sawyer and were invalid. Litigation continued for a number of years. Eventually on 6 October 1889, a judge ruled that Edison’s electric light improvement claim for “a filament of carbon of high resistance” was valid.^[39]

In 1897, German physicist and chemist Walther Nernst developed the Nernst lamp, a form of incandescent lamp that used a ceramic global and did not require enclosure in a vacuum or inert gas.^{[40][41]} Twice as efficient as carbon filament lamps, Nernst lamps were briefly popular until overtaken by lamps using metal filaments.

2.2 Tungsten bulbs

On 13 December 1904, Hungarian Sándor Just and Croatian Franjo Hanaman were granted a Hungarian patent (No. 34541) for a tungsten filament lamp that lasted longer and gave brighter light than the carbon filament. Tungsten filament lamps were first marketed by the Hungarian company Tungram in 1904. This type is often called Tungram-bulbs in many European countries.^[42] Their experiments also showed that the luminosity of bulbs filled with an inert gas was higher than in vacuum.^[43] The tungsten filament outlasted all other types.

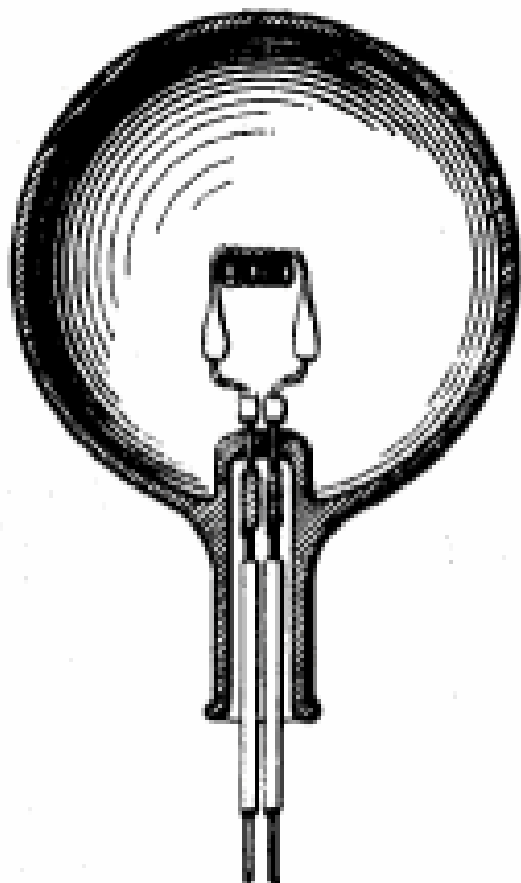

U.S. Patent 0,223,898 by Thomas Edison for an improved electric lamp, 27 January 1880

In 1906, the General Electric Company patented a method of making filaments from sintered tungsten and in 1911, used ductile tungsten wire for incandescent light bulbs.

In 1913, Irving Langmuir found that filling a lamp with inert gas instead of a vacuum resulted in twice the luminous efficacy and reduction of bulb blackening. In 1924, Marvin Pipkin, an American chemist, patented a process for frosting the inside of lamp bulbs without weakening them, and in 1947, he patented a process for coating the inside of lamps with silica.

Between 1924 and the outbreak of the Second World War, the Phoebus cartel attempted to fix prices and sales quotas for bulb manufacturers outside of North America.

In 1930, Hungarian Imre Bródy filled lamps with krypton gas rather than argon, and designed a process to obtain krypton from air. Production of krypton filled lamps based on his invention started at Ajka in 1937, in a factory co-designed by Polányi and Hungarian-born physicist Egon Orowan.^[44]

By 1964, improvements in efficiency and production of incandescent lamps had reduced the cost of providing a



Hungarian advertising of the Tungstam-bulb from 1904. This was the first light bulb that used a filament made from tungsten instead of carbon. The inscription reads: wire lamp with a drawn wire – indestructible.

given quantity of light by a factor of thirty, compared with the cost at introduction of Edison's lighting system.^[45]

Consumption of incandescent light bulbs grew rapidly in the US. In 1885, an estimated 300,000 general lighting service lamps were sold, all with carbon filaments. When tungsten filaments were introduced, about 50 million lamp sockets existed in the US. In 1914, 88.5 million lamps were used, (only 15% with carbon filaments), and by 1945, annual sales of lamps were 795 million (more than 5 lamps per person per year).^[46]



Xenon halogen lamp with an E27 base, which can replace a non-halogen bulb

2.3 Efficacy, efficiency, and environmental impact

Of the power consumed by typical incandescent light bulbs, 95% or more is converted into heat rather than visible light.^[1] Other electrical light sources are more effective.

Luminous *efficacy* of a light source may be defined in two ways. The radiant luminous efficacy (LER) is the ratio of the visible light flux emitted (the *luminous flux*) to the total power radiated over all wavelengths. The source luminous efficacy (LES) is the ratio of the visible light flux emitted (the *luminous flux*) to the total power input to the source, such as a lamp.^[47] Visible light is measured in *lumens*, a unit which is defined in part by the differing sensitivity of the human eye to different wavelengths of light. Not all wavelengths of visible electromagnetic energy are equally effective at stimulating the human eye; the luminous efficacy of radiant energy (LER) is a measure of how well the distribution of energy matches the perception of the eye. The units of luminous efficacy are “lumens per watt” (lpw). The maximum LER possible is 683 lm/W for monochromatic green light at 555 nanome-

ters wavelength, the peak sensitivity of the human eye.

The luminous *efficiency* is defined as the ratio of the luminous efficacy to the theoretical maximum luminous efficacy of 683 lpw, and, as for luminous efficacy, is of two types, radiant luminous efficiency (LFR) and source luminous efficacy (LFS).

The chart below lists values of overall luminous efficacy and efficiency for several types of general service, 120-volt, 1000-hour lifespan incandescent bulb, and several idealized light sources. The values for the incandescent bulbs are source efficiencies and efficacies. The values for the ideal sources are radiant efficiencies and efficacies. A similar chart in the article on *luminous efficacy* compares a broader array of light sources to one another.

The spectrum emitted by a blackbody radiator at temperatures of incandescent bulbs does not match the sensitivity characteristics of the human eye; the light emitted does not appear white, and most is not in the range of wavelengths at which the eye is most sensitive. Tungsten filaments radiate mostly infrared radiation at temperatures where they remain solid – below 3,695 K (3,422 °C; 6,191 °F). Donald L. Klipstein explains it this way: “An ideal thermal radiator produces visible light most efficiently at temperatures around 6,300 °C (6,600 K; 11,400 °F). Even at this high temperature, a lot of the radiation is either infrared or ultraviolet, and the theoretical luminous efficacy (LER) is 95 lumens per watt.”^[48] No known material can be used as a filament at this ideal temperature, which is hotter than the sun’s surface. An upper limit for incandescent lamp luminous efficacy (LER) is around 52 lumens per watt, the theoretical value emitted by tungsten at its melting point.^[45]

Although inefficient, incandescent light bulbs have an advantage in applications where accurate color reproduction is important, since the continuous blackbody spectrum emitted from an incandescent light-bulb filament yields near-perfect color rendition, with a *color rendering index* of 100 (the best possible).^[50] White-balancing is still required to avoid too “warm” or “cool” colors, but this is a simple process that requires only the color temperature in Kelvin as input for modern, digital visual reproduction equipment such as video or still cameras unless it is completely automated. The color-rendering performance of incandescent lights cannot be matched by LEDs or fluorescent lights, although they can offer satisfactory performance for non-critical applications such as home lighting.^{[51][52]} White-balancing such lights is therefore more complicated, requiring additional adjustments to reduce for example green-magenta color casts, and even when properly white-balanced, the color reproduction will not be perfect.

For a given quantity of light, an incandescent light bulb produces more heat (and thus consumes more power) than a *fluorescent lamp*. In buildings where air conditioning is used, incandescent lamps’ heat output increases load on the air conditioning system.^[53] Heat from lights

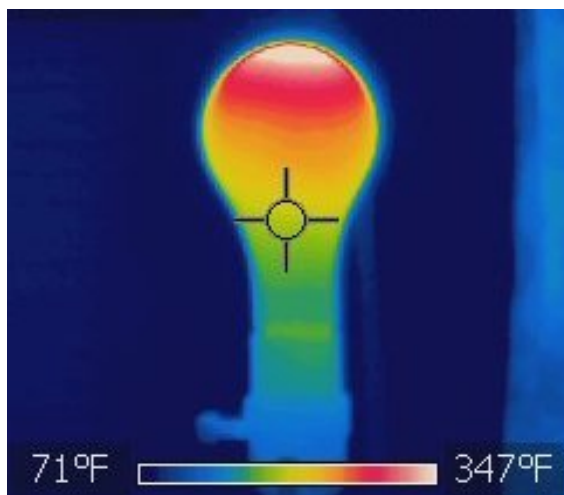

Thermal image of an incandescent bulb. Much of the energy is emitted as infrared. The IR heats the glass, which conducts the heat to the surrounding air, producing convection.

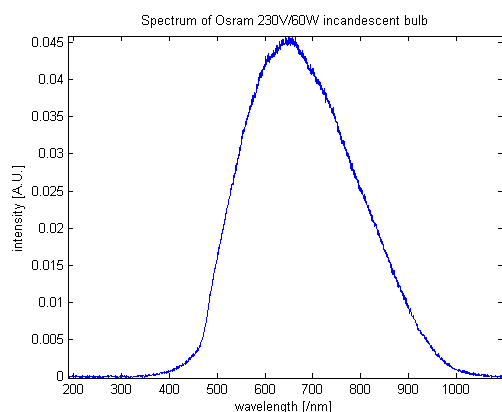

Spectral distribution of a typical incandescent lamp.

will displace heat required from a building's heating system, but generally space heating energy is of lower cost than heat from lighting.

Halogen incandescent lamps have higher efficacy, which will allow a halogen light to use less power to produce the same amount of light compared to a non-halogen incandescent light. The expected life span of halogen lights is also generally longer compared to non-halogen incandescent lights, and halogen lights produce a more constant light-output over time, without much dimming.^[54]

There are many non-incandescent light sources, such as the fluorescent lamp, high-intensity discharge lamps and LED lamps, which have higher luminous efficiency, and some have been designed to be retrofitted in fixtures for incandescent lights. These devices produce light by luminescence. These lamps produce discrete spectral lines and do not have the broad "tail" of invisible infrared emissions. By careful selection of which electron energy level transitions are used, and fluorescent coatings which modify the spectral distribution, the spectrum emitted

can be tuned to mimic the appearance of incandescent sources, or other different color temperatures of white light. Due to the discrete spectral lines rather than a continuous spectrum, the light is not ideal for applications such as photography and cinematography.^{[51][52]}

2.3.1 Cost of lighting

See also: Architectural lighting design

The initial cost of an incandescent bulb is small compared to the cost of the energy it uses over its lifetime. Incandescent bulbs have a shorter life than most other lighting, an important factor if replacement is inconvenient or expensive. Some types of lamp, including incandescent and fluorescent, emit less light as they age; this may be an inconvenience, or may reduce effective lifetime due to lamp replacement before total failure. A comparison of incandescent lamp operating cost with other light sources must include illumination requirements, cost of the lamp and labor cost to replace lamps (taking into account effective lamp lifetime), cost of electricity used, effect of lamp operation on heating and air conditioning systems. When used for lighting in houses and commercial buildings, the energy lost to heat can significantly increase the energy required by a building's air conditioning system, although during the heating season such heat is not all wasted, but is not as effective as the heating system.^[55]

2.3.2 Measures to ban use

Main article: Phase-out of incandescent light bulbs

Since incandescent light bulbs use more energy than alternatives such as CFLs and LED lamps, many governments have introduced measures to ban their use,^[56] by setting minimum efficacy standards higher than can be achieved by incandescent lamps.

In the US, federal law has scheduled the most common incandescent light bulbs to be phased out by 2014, to be replaced with more energy-efficient light bulbs.^[57] Traditional incandescent light bulbs were phased out in Australia in November 2009.^[58]

Objections to banning the use of incandescent light bulbs include the higher initial cost and quality of light of alternatives.^[59] Some people have concerns about the health effects of fluorescent lamps.

2.3.3 Efforts to improve efficiency

Some research has been carried out to improve the efficacy of commercial incandescent lamps. In 2007, the consumer lighting division of General Electric announced a "high efficiency incandescent" (HEI) lamp

project, which they claimed would ultimately be as much as four times more efficient than current incandescents, although their initial production goal was to be approximately twice as efficient.^{[60][61]} The HEI program was terminated in 2008 due to slow progress.^{[62][63]}

US Department of Energy research at Sandia National Laboratories initially indicated the potential for dramatically improved efficiency from a photonic lattice filament.^[60] However, later work indicated that initially promising results were in error.^[64]

Prompted by US legislation mandating increased bulb efficiency by 2012, new “hybrid” incandescent bulbs have been introduced by Philips. The “Halogen Energy Saver” incandescent is 30 percent more efficient than traditional designs, using a special chamber to reflect formerly wasted heat back to the filament to provide additional lighting power.^[65]

2.4 Construction

Incandescent light bulbs consist of an air-tight glass enclosure (the envelope, or bulb) with a filament of tungsten wire inside the bulb, through which an electric current is passed. Contact wires and a base with two (or more) conductors provide electrical connections to the filament. Incandescent light bulbs usually contain a stem or glass mount anchored to the bulb’s base that allows the electrical contacts to run through the envelope without air or gas leaks. Small wires embedded in the stem in turn support the filament and its lead wires.

An electric current heats the filament to typically 2,000 to 3,300 K (3,140 to 5,480 °F), well below tungsten’s melting point of 3,695 K (6,191 °F). Filament temperatures depend on the filament type, shape, size, and amount of current drawn. The heated filament emits light that approximates a continuous spectrum. The useful part of the emitted energy is visible light, but most energy is given off as heat in the near-infrared wavelengths.

Three-way light bulbs have two filaments and three conducting contacts in their bases. The filaments share a common ground, and can be lit separately or together. Common wattages include 30–70–100, 50–100–150, and 100–200–300, with the first two numbers referring to the individual filaments, and the third giving the combined wattage.

Most light bulbs have either clear or coated glass. The coated glass bulbs have a white powdery substance on the inside called kaolin. Kaolin, or kaolinite, is a white, chalky clay in a very fine powder form, that is blown in and electrostatically deposited on the interior of the bulb. It diffuses the light emitted from the filament, producing a more gentle and evenly distributed light. Manufacturers may add pigments to the kaolin to adjust the characteristics of the final light emitted from the bulb. Kaolin diffused bulbs are used extensively in inte-

rior lighting because of their comparatively gentle light. Other kinds of colored bulbs are also made, including the various colors used for “party bulbs”, Christmas tree lights and other decorative lighting. These are created by coloring the glass with a dopant; which is often a metal like cobalt (blue) or chromium (green).^[66] Neodymium-containing glass is sometimes used to provide a more natural-appearing light.

Many arrangements of electrical contacts are used. Large lamps may have a screw base (one or more contacts at the tip, one at the shell) or a bayonet base (one or more contacts on the base, shell used as a contact or used only as a mechanical support). Some tubular lamps have an electrical contact at either end. Miniature lamps may have a wedge base and wire contacts, and some automotive and special purpose lamps have screw terminals for connection to wires. Contacts in the lamp socket allow the electric current to pass through the base to the filament. Power ratings for incandescent light bulbs range from about 0.1 watt to about 10,000 watts.

The glass bulb of a general service lamp can reach temperatures between 200 and 260 °C (392 and 500 °F). Lamps intended for high power operation or used for heating purposes will have envelopes made of hard glass or fused quartz.^[45]

Further information: [Lightbulb socket](#)

2.4.1 Gas fill

The bulb is filled with an inert gas, to reduce evaporation of the filament and prevent its oxidation at a pressure of about 70 kPa (0.7 atm).^[67]

The role of the gas is to prevent evaporation of the filament, without introducing significant heat losses. For these properties, chemical inertness and high atomic or molecular weight is desirable. The presence of gas molecules knocks the liberated tungsten atoms back to the filament, reducing its evaporation and allowing it to be operated at higher temperature without reducing its life (or, for operating at the same temperature, prolongs the filament life). It however introduces heat losses (and therefore efficiency loss) from the filament, by heat conduction and heat convection.

Early lamps, and some small modern lamps used only a vacuum to protect the filament from oxygen. This however increases evaporation of the filament, albeit it eliminates the heat losses.

The most common fills are:^[68]

- Vacuum, used in small lamps. Provides best thermal insulation of the filament but does not protect against its evaporation. Used also in larger lamps where the outer bulb surface temperature has to be limited.
- Argon (93%) and nitrogen (7%), where argon is

used for its inertness, low thermal conductivity and low cost, and the nitrogen is added to increase the breakdown voltage and prevent arcing between parts of the filament^[67]

- Nitrogen, used in some higher-power lamps, e.g. projection lamps, and where higher breakdown voltage is needed due to proximity of filament parts or lead-in wires
- **Krypton**, which is more advantageous than argon due to its yet higher atomic weight and yet lower thermal conductivity (which also allows use of smaller bulbs), but its use is hindered by much higher cost, confining it mostly to smaller-size bulbs.
- Krypton mixed with **xenon**, where xenon improves the gas properties further due to its yet higher atomic weight. Its use is however limited by its very high cost. The improvements by xenon are however modest in comparison to its cost.
- **Hydrogen**, in special flashing lamps where rapid filament cooling is required; its high thermal conductivity is exploited here.

The gas fill must be free of traces of water. In presence of the hot filament, water reacts with tungsten forming tungsten trioxide and atomic hydrogen. The oxide deposits on the bulb inner surface and reacts with hydrogen, decomposing to metallic tungsten and water. Water then cycles back to the filament. This greatly accelerates the bulb blackening, in comparison with evaporation-only.

The gas layer just around the filament (called the Langmuir layer) is stagnant, heat transfer occurs only by conduction. Only at some distance the convection takes over to carry the heat to the bulb envelope.

The orientation of the filament against the convective gas flow influences efficiency. Gas flowing parallel to the filament, e.g. in case of a vertically oriented bulb with vertical (or axial) filament, allows running the filament hotter and reduces convective losses.

The efficiency of the gas increases with the increasing bulb filament diameter. Thin-filament, low-power bulbs benefit less from a fill gas, so are often only evacuated. In special cases, when rapid cooling of powered-off filament is needed (e.g. in flashing lights), gas fill is used; hydrogen provides an advantage here.

Early lightbulbs with carbon filaments also used carbon monoxide, nitrogen, or mercury vapor. Carbon filaments however had to operate at lower temperatures than tungsten ones, so the effect of the fill gas was not significant as the heat losses offset the benefits.



Tantalum filament light bulb, 1908, the first metal filament bulb

2.5 Manufacturing

Early lamps were laboriously assembled by hand. After automatic machinery was developed the cost of lamps fell.

In manufacturing the glass bulb, a type of “ribbon machine” is used. A continuous ribbon of glass is passed along a conveyor belt, heated in a furnace, and then blown by precisely aligned air nozzles through holes in the conveyor belt into molds. Thus the glass bulbs are created. After the bulbs are blown, and cooled, they are cut off the ribbon machine; a typical machine of this sort produces 50,000 bulbs per hour.^[69] The filament and its supports are assembled on a glass stem, which is fused to the bulb. The air is pumped out of the bulb, and the evacuation tube in the stem press is sealed by a flame. The bulb is then inserted into the lamp base, and the whole assembly tested.

2.6 Filament

The first successful light bulb filaments were made of carbon (from carbonized paper or bamboo). Early carbon filaments had a negative temperature coefficient of resistance — as they got hotter, their electrical resistance decreased. This made the lamp sensitive to fluctuations in the power supply, since a small increase of voltage would cause the filament to heat up, reducing its resistance and causing it to draw even more power and heat even further. In the “flashing” process, carbon filaments were heated by current passing through them while in an evacuated vessel containing hydrocarbon vapor (usually gasoline). The carbon deposited on the filament by this treatment improved the uniformity and strength of filaments as well as their efficiency. A metallized or “graphitized” filament was first heated in a high-temperature oven before flashing and lamp assembly. This transformed the carbon into graphite which further strengthened and smoothed the filament. This also changed the filament to have a *positive* temperature coefficient, like a metallic conductor, and helped stabilize the lamp’s power consumption, temperature and light output against minor variations in supply voltage.

In 1902, the Siemens company developed a tantalum lamp filament. These lamps were more efficient than even graphitized carbon filaments and could operate at higher temperatures. Since tantalum metal has a lower resistivity than carbon, the tantalum lamp filament was quite long and required multiple internal supports. The metal filament had the property of gradually shortening in use; the filaments were installed with large loops that tightened in use. This made lamps in use for several hundred hours quite fragile.^[70] Metal filaments had the property of breaking and re-welding, though this would usually decrease resistance and shorten the life of the filament. General Electric bought the rights to use tantalum filaments and produced them in the US until 1913.^[71]

From 1898 to around 1905, osmium was also used as a lamp filament in Europe, and the metal was so expensive that used broken lamps could be returned for partial credit.^[72] It could not be made for 110 V or 220 V so several lamps were wired in series for use on standard voltage circuits.



How a tungsten filament is made

In 1906, the tungsten filament was introduced. Tungsten metal was initially not available in a form that allowed it to be drawn into fine wires. Filaments made from sintered tungsten powder were quite fragile. By 1910, a process was developed by William D. Coolidge at General Electric for production of a ductile form of tungsten. The process required pressing tungsten powder into bars, then several steps of sintering, swaging, and then wire drawing. It was found that very pure tungsten formed filaments that sagged in use, and that a very small “doping” treatment with potassium, silicon, and aluminium oxides at the level of a few hundred parts per million greatly improved the life and durability of the tungsten filaments.^[73]

2.6.1 Coiled coil filament

To improve the efficiency of the lamp, the filament usually consists of multiple coils of coiled fine wire, also known as a ‘coiled coil’. For a 60-watt 120-volt lamp, the uncoiled length of the tungsten filament is usually 22.8 inches (580 mm),^[45] and the filament diameter is 0.0018 inches (0.046 mm). The advantage of the coiled coil is that evaporation of the tungsten filament is at the rate of a tungsten cylinder having a diameter equal to that of the coiled coil. The coiled-coil filament evaporates more slowly than a straight filament of the same surface area and light-emitting power. As a result, the filament can then run hotter, which results in a more efficient light source, while reducing the evaporation so that the filament will last longer than a straight filament at the same temperature.

There are several different shapes of filament used in lamps, with differing characteristics. Manufacturers designate the types with codes such as C-6, CC-6, C-2V, CC-2V, C-8, CC-88, C-2F, CC-2F, C-Bar, C-Bar-6, C-8I, C-2R, CC-2R, and Axial.

Electrical filaments are also used in hot cathodes of fluorescent lamps and vacuum tubes as a source of electrons or in vacuum tubes to heat an electron-emitting electrode.

2.6.2 Reducing filament evaporation

One of the problems of the standard electric light bulb is evaporation of the filament. Small variations in resistivity along the filament cause “hot spots” to form at points of higher resistivity,^[46] a variation of diameter of only 1% will cause a 25% reduction in service life.^[45] These hot spots evaporate faster than the rest of the filament, which increases the resistance at that point—this creates a positive feedback that ends in the familiar tiny gap in an otherwise healthy-looking filament. Irving Langmuir found that an inert gas, instead of vacuum, would retard evaporation. General service incandescent light bulbs over about 25 watts in rating are now filled with a mixture of mostly argon and some nitrogen,^[74] or sometimes

krypton.^[75] Since a filament breaking in a gas-filled bulb can form an **electric arc**, which may spread between the terminals and draw very heavy current, intentionally thin lead-in wires or more elaborate protection devices are therefore often used as **fuses** built into the light bulb.^[76] More nitrogen is used in higher-voltage lamps to reduce the possibility of arcing.

While inert gas reduces filament evaporation, it also conducts heat from the filament, thereby cooling the filament and reducing efficiency. At constant pressure and temperature, the thermal conductivity of a gas depends upon the molecular weight of the gas and the cross sectional area of the gas molecules. Higher molecular weight gasses have lower thermal conductivity, because both the molecular weight is higher and also the cross sectional area is higher. **Xenon** gas improves efficiency because of its high molecular weight, but is also more expensive, so its use is limited to smaller lamps.^[77]

During ordinary operation, the tungsten of the filament evaporates; hotter, more-efficient filaments evaporate faster. Because of this, the lifetime of a filament lamp is a trade-off between efficiency and longevity. The trade-off is typically set to provide a lifetime of several hundred to 2,000 hours for lamps used for general illumination. Theatrical, photographic, and projection lamps may have a useful life of only a few hours, trading life expectancy for high output in a compact form. Long-life general service lamps have lower efficiency but are used where the cost of changing the lamp is high compared to the value of energy used.

Filament notching describes another phenomenon that limits the life of lamps. Lamps operated on direct current develop random stairstep irregularities on the filament surface, reducing the cross section and further increasing heat and evaporation of tungsten at these points. In small lamps operated on direct current, lifespan may be cut in half compared to AC operation. Different alloys of tungsten and rhenium can be used to counteract the effect.^{[78][79]}

If a light bulb envelope leaks, the hot tungsten filament reacts with air, yielding an aerosol of brown tungsten nitride, brown tungsten dioxide, violet-blue tungsten pentoxide, and yellow tungsten trioxide that then deposits on the nearby surfaces or the bulb interior.

2.6.3 Bulb blackening

In a conventional lamp, the evaporated tungsten eventually condenses on the inner surface of the glass envelope, darkening it. For bulbs that contain a vacuum, the darkening is uniform across the entire surface of the envelope. When a filling of inert gas is used, the evaporated tungsten is carried in the thermal convection currents of the gas, depositing preferentially on the uppermost part of the envelope and blackening just that portion of the envelope. An incandescent lamp that gives 93% or less of

its initial light output at 75% of its rated life is regarded as unsatisfactory, when tested according to IEC Publication 60064. Light loss is due to filament evaporation and bulb blackening.^[80] Study of the problem of bulb blackening led to the discovery of the **Edison effect**, thermionic emission and invention of the **vacuum tube**.

A very small amount of water vapor inside a light bulb can significantly affect lamp darkening. Water vapor dissociates into hydrogen and oxygen at the hot filament. The oxygen attacks the tungsten metal, and the resulting tungsten oxide particles travel to cooler parts of the lamp. Hydrogen from water vapor reduces the oxide, reforming water vapor and continuing this *water cycle*.^[46] The equivalent of a drop of water distributed over 500,000 lamps will significantly increase darkening.^[45] Small amounts of substances such as zirconium are placed within the lamp as a **getter** to react with any oxygen that may bake out of the lamp components during operation.

Some old, high-powered lamps used in theater, projection, searchlight, and lighthouse service with heavy, sturdy filaments contained loose tungsten powder within the envelope. From time to time, the operator would remove the bulb and shake it, allowing the tungsten powder to scrub off most of the tungsten that had condensed on the interior of the envelope, removing the blackening and brightening the lamp again.^[81]

2.6.4 Halogen lamps

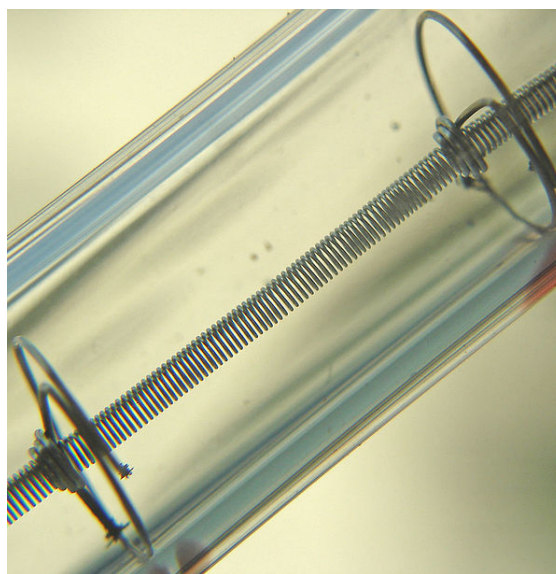

Close-up of a tungsten filament inside a halogen lamp. The two ring-shaped structures left and right are filament supports.

Main article: [Halogen lamp](#)

The **halogen lamp** reduces uneven evaporation of the filament and eliminates darkening of the envelope by filling the lamp with a halogen gas at low pressure, rather

than an inert gas. The **halogen cycle** increases the lifetime of the bulb and prevents its darkening by redepositing tungsten from the inside of the bulb back onto the filament. The halogen lamp can operate its filament at a higher temperature than a standard gas filled lamp of similar power without loss of operating life. Such bulbs are much smaller than normal incandescent bulbs, and are widely used where intense illumination is needed in a limited space. **Fiber-optic lamps** for **optical microscopy** is one typical application.

2.6.5 Incandescent arc lamps

A variation of the incandescent lamp did not use a hot wire filament, but instead used an arc struck on a spherical bead electrode to produce heat. The electrode then became incandescent, with the arc contributing little to the light produced. Such lamps were used for projection or illumination for scientific instruments such as **microscopes**. These arc lamps ran on relatively low voltages and incorporated tungsten filaments to start ionization within the envelope. They provided the intense concentrated light of an **arc lamp** but were easier to operate. Developed around 1915, these lamps were displaced by mercury and **xenon arc lamps**.^{[82][83][84]}

2.7 Electrical characteristics

2.7.1 Power

Incandescent lamps are nearly pure resistive loads with a **power factor** of 1. This means the actual power consumed (in watts) and the apparent power (in volt-amperes) are equal. Incandescent light bulbs are usually marketed according to the **electrical power** consumed. This is measured in watts and depends mainly on the **resistance** of the filament, which in turn depends mainly on the filament's length, thickness, and material. For two bulbs of the same voltage, type, color, and clarity, the higher-powered bulb gives more light.

The table shows the approximate typical output, in **lumens**, of standard incandescent light bulbs at various powers. Light output of a 230 V version is usually slightly less than that of a 120 V version. The lower current (higher voltage) filament is thinner and has to be operated at a slightly lower temperature for same life expectancy, and that reduces energy efficiency.^[87] The lumen values for "soft white" bulbs will generally be slightly lower than for clear bulbs at the same power.

2.7.2 Current and resistance

The actual resistance of the filament is temperature dependent. The cold resistance of tungsten-filament lamps is about 1/15 the hot-filament resistance when the lamp is

operating. For example, a 100-watt, 120-volt lamp has a resistance of 144 ohms when lit, but the cold resistance is much lower (about 9.5 ohms).^{[45][88]} Since incandescent lamps are resistive loads, simple phase-control **TRIAC dimmers** can be used to control brightness. Electrical contacts may carry a "T" rating symbol indicating that they are designed to control circuits with the high inrush current characteristic of tungsten lamps. For a 100-watt, 120-volt general-service lamp, the current stabilizes in about 0.10 seconds, and the lamp reaches 90% of its full brightness after about 0.13 seconds.^[89]

Carbon filament bulbs have the opposite characteristic. The resistance of a carbon filament is higher when it is cold than when it is operating. In the case of a 240 Volt, 60 Watt carbon filament bulb, the resistance of the filament when at operating temperature is 960 Ohms, but rises to around 1500 Ohms when cold.

2.8 Physical characteristics

2.8.1 Bulb shapes

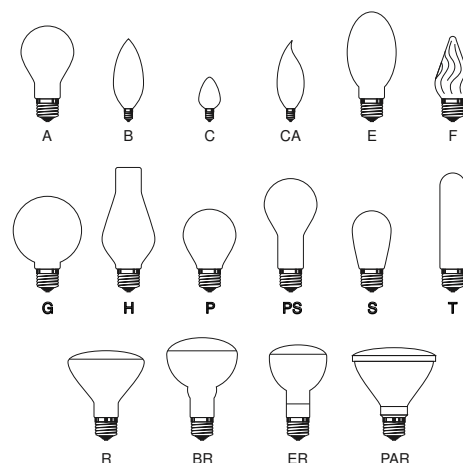

Incandescent light bulbs come in a range of shapes and sizes.

Incandescent light bulbs come in a range of shapes and sizes. The names of the shapes may be slightly different in some regions. Many of these shapes have a designation consisting of one or more letters followed by one or more numbers, e.g. A55 or PAR38. The letters represent the shape of the bulb. The numbers represent the maximum diameter, either in $\frac{1}{8}$ of an inch, or in millimeters, depending on the shape and the region. For example, 63 mm reflectors are designated R63, but in the US, they are known as R20 (2.5 in).^[90] However, in both regions, a PAR38 reflector is known as PAR38.

Common shapes:

General Service Light emitted in (nearly) all directions.
Available either clear or frosted.

Types: General (A), Mushroom, elliptical (E), sign (S), tubular (T)

120 V sizes: A17, 19 and 21

230 V sizes: A55 and 60

High Wattage General Service Lamps greater than 200 watts.

Types: Pear-shaped (PS)

Decorative lamps used in chandeliers, etc.

Types: candle (B), twisted candle, bent-tip candle (CA & BA), flame (F), globe (G), lantern chimney (H), fancy round (P)

230 V sizes: P45, G95

Reflector (R) Reflective coating inside the bulb directs light forward. Flood types (FL) spread light. Spot types (SP) concentrate the light. Reflector (R) bulbs put approximately double the amount of light (foot-candles) on the front central area as General Service (A) of same wattage.

Types: Standard reflector (R), elliptical reflector (ER), crown-silvered

120 V sizes: R16, 20, 25 and 30

230 V sizes: R50, 63, 80 and 95

Parabolic aluminized reflector (PAR) Parabolic aluminized reflector (PAR) bulbs control light more precisely. They produce about four times the concentrated light intensity of general service (A), and are used in recessed and track lighting. Weatherproof casings are available for outdoor spot and flood fixtures.

120 V sizes: PAR 16, 20, 30, 38, 56 and 64

230 V sizes: PAR 16, 20, 30, 38, 56 and 64

Available in numerous spot and flood beam spreads.

Like all light bulbs, the number represents the diameter of the bulb in $\frac{1}{8}$ of an inch. Therefore, a PAR 16 is 2 in in diameter, a PAR 20 is 2.5 in in diameter, PAR 30 is 3.75 in and a PAR 38 is 4.75 in in diameter.

Multifaceted reflector (MR)

HIR "HIR" is a GE designation for a lamp with an infrared reflective coating. Since less heat escapes, the filament burns hotter and more efficiently.^[91] The Osram designation for a similar coating is "IRC".^[92]



40-watt light bulbs with standard E10, E14 and E27 Edison screw base



The double-contact bayonet cap on an incandescent bulb

2.8.2 Lamp bases

Main article: [Lightbulb sockets](#)

Very small lamps may have the filament support wires extended through the base of the lamp, and can be directly soldered to a printed circuit board for connections. Some reflector-type lamps include screw terminals for connection of wires. Most lamps have metal bases that fit in a socket to support the lamp and conduct current to the filament wires. In the late 19th century, manufacturers introduced a multitude of incompatible lamp bases. General Electric introduced standard base sizes for tungsten incandescent lamps under the Mazda trademark in 1909. This standard was soon adopted across the US, and the Mazda name was used by many manufacturers

under license through 1945. Today most incandescent lamps for general lighting service use an Edison screw in candelabra, intermediate, or standard or mogul sizes, or double contact bayonet base. Technical standards for lamp bases include ANSI standard C81.67 and IEC standard 60061-1 for common commercial lamp sizes, to ensure interchangeability between different manufacturer's products. Bayonet base lamps are frequently used in automotive lamps to resist loosening due to vibration. A bipin base is often used for halogen or reflector lamps.^[93]

Lamp bases may be secured to the bulb with a cement, or by mechanical crimping to indentations molded into the glass bulb.

Miniature lamps used for some automotive lamps or decorative lamps have wedge bases that have a partial plastic or even completely glass base. In this case, the wires wrap around to the outside of the bulb, where they press against the contacts in the socket. Miniature Christmas bulbs use a plastic wedge base as well.

Lamps intended for use in optical systems such as film projectors, microscope illuminators, or stage lighting instruments have bases with alignment features so that the filament is positioned accurately within the optical system. A screw-base lamp may have a random orientation of the filament when the lamp is installed in the socket.



The Centennial Light is the longest-lasting light bulb in the world.

2.9 Light output and lifetime

See also: Lamp rating

Incandescent lamps are very sensitive to changes in the supply voltage. These characteristics are of great practical and economic importance.

For a supply voltage V near the rated voltage of the lamp:

- *Light* output is approximately proportional to $V^{3.4}$
- *Power* consumption is approximately proportional to $V^{1.6}$
- *Lifetime* is approximately proportional to V^{-16}
- *Color temperature* is approximately proportional to $V^{0.42}$ ^[94]

This means that a 5% reduction in operating voltage will more than double the life of the bulb, at the expense of reducing its light output by about 16%. This may be a very acceptable trade off for a light bulb that is in a difficult-to-access location (for example, traffic lights or fixtures hung from high ceilings). Long-life bulbs take advantage of this trade-off. Since the value of the electric power they consume is much more than the value of the lamp, general service lamps emphasize efficiency over long operating life. The objective is to minimize the cost of light,

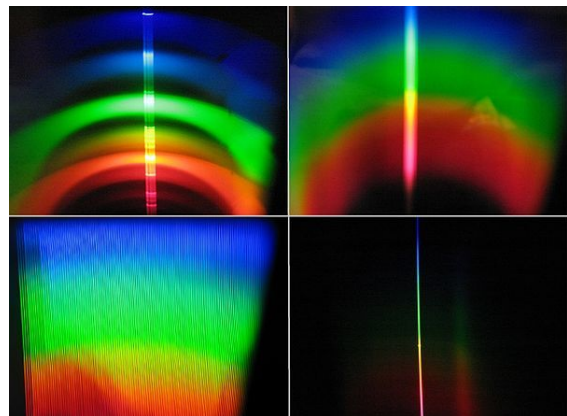

Various lighting spectra as viewed in a diffraction grating. Upper left: fluorescent lamp, upper right: incandescent bulb, lower left: white LED, lower right: candle flame.

not the cost of lamps.^[45] Early bulbs had a life of up to 2500 hours, but in 1924 a cartel agreed to limit life to 1000 hours.^[95] When this was exposed in 1953, General Electric and other leading American manufacturers were banned from limiting the life.^[96]

The relationships above are valid for only a few percent change of voltage around rated conditions, but they do indicate that a lamp operated at much lower than rated voltage could last for hundreds of times longer than at rated conditions, albeit with greatly reduced light output. The

"Centennial Light" is a light bulb that is accepted by the *Guinness Book of World Records* as having been burning almost continuously at a fire station in Livermore, California, since 1901. However, the bulb emits the equivalent light of a four watt bulb. A similar story can be told of a 40-watt bulb in Texas that has been illuminated since 21 September 1908. It once resided in an opera house where notable celebrities stopped to take in its glow, and was moved to an area museum in 1977.^[97]

In flood lamps used for photographic lighting, the trade-off is made in the other direction. Compared to general-service bulbs, for the same power, these bulbs produce far more light, and (more importantly) light at a higher color temperature, at the expense of greatly reduced life (which may be as short as two hours for a type P1 lamp). The upper temperature limit for the filament is the melting point of the metal. Tungsten is the metal with the highest melting point, 3,695 K (6,191 °F). A 50-hour-life projection bulb, for instance, is designed to operate only 50 °C (122 °F) below that melting point. Such a lamp may achieve up to 22 lumens per watt, compared with 17.5 for a 750-hour general service lamp.^[45]

Lamps designed for different voltages have different luminous efficacy. For example, a 100-watt, 120-volt lamp will produce about 17.1 lumens per watt. A lamp with the same rated lifetime but designed for 230 V would produce only around 12.8 lumens per watt, and a similar lamp designed for 30 volts (train lighting) would produce as much as 19.8 lumens per watt.^[45] Lower voltage lamps have a thicker filament, for the same power rating. They can run hotter for the same lifetime before the filament evaporates.

The wires used to support the filament make it mechanically stronger, but remove heat, creating another tradeoff between efficiency and long life. Many general-service 120-volt lamps use no additional support wires, but lamps designed for "rough service" or "vibration service" may have as many as five. Low-voltage lamps have filaments made of heavier wire and do not require additional support wires.

Very low voltages are inefficient since the lead wires would conduct too much heat away from the filament, so the practical lower limit for incandescent lamps is 1.5 volts. Very long filaments for high voltages are fragile, and lamp bases become more difficult to insulate, so lamps for illumination are not made with rated voltages over 300 volts.^[45] Some infrared heating elements are made for higher voltages, but these use tubular bulbs with widely separated terminals.

2.10 See also

- Flash (photography)
- Lampshade

- Light tube
- Lightbulb jokes
- List of light sources
- Longest-lasting light bulbs
- Over-illumination
- Photometry (optics)
- Spectrometer

2.11 References

- [1] Keefe, T.J. (2007). "The Nature of Light". Archived from the original on 2012-07-24. Retrieved 2007-11-05.
- [2] "Storey's guide to raising chickens" Damerow, Gail. Storey Publishing, LLC; 2nd edition (12 January 1995), ISBN 978-1-58017-325-4. page 221. Retrieved 10 November 2009.
- [3] "277 Secrets Your Snake and Lizard Wants you to Know Unusual and useful Information for Snake Owners & Snake Lovers" Cooper,Paulette. Ten Speed Press (1 March 2004), ISBN 978-1-58008-035-4. Page 161. Retrieved 10 November 2009.
- [4] "El peligro de los bombillos ahorradores". El Espectador. Retrieved 22 October 2014.
- [5] "Informe técnico preliminar - Estándar mínimo de eficiencia energética" (PDF). Ministry of Energy - Chile. Retrieved 22 October 2014.
- [6] Friedel, Robert, and Paul Israel. 1986. *Edison's electric light: biography of an invention*. New Brunswick, New Jersey: Rutgers University Press. pages 115–117
- [7] Hughes, Thomas P. (1977). "Edison's method". In Pickett, W. B. *Technology at the Turning Point*. San Francisco: San Francisco Press. pp. 5–22.
- [8] Hughes, Thomas P. (2004). *American Genesis: A Century of Invention and Technological Enthusiasm* (2nd ed.). Chicago: University of Chicago Press. ISBN 978-0-22635-927-4.
- [9] Josephson, Matthew (1959). *Edison: a biography*. McGraw Hill. ISBN 0-471-54806-5.
- [10] Davis, L.J. "Fleet Fire." Arcade Publishing, New York, 2003. ISBN 1-55970-655-4
- [11] Houston and Kennely 1896, chapter 2
- [12] Challoner, Jack et al. (2009). *1001 Inventions That Changed The World*. Hauppauge NY: Barrons Educational Series. p. 305.
- [13] Houston and Kennely 1896, page 24
- [14] Charles D. Wrege *J.W. Starr: Cincinnati's Forgotten Genius*, Cincinnati Historical Society Bulletin 34 (Summer 1976): 102–120. Retrieved 2010 February 16.

- [15] Derry, T.K.; Williams, Trevor (1960). *A Short History of Technology*. Oxford University Press. ISBN 0-486-27472-1.
- [16] “John Wellington Starr”. Retrieved 2010 February 16.
- [17] Many of the above lamps are illustrated and described in Edwin J. Houston and A. E. Kennely “Electric Incandescent Lighting”, The W. J. Johnston Company, New York, 1896 pages 18–42. Available from the Internet Archive.
- [18] *Edison Electric Light Co. vs. United States Electric Lighting Co.*, Federal Reporter, F1, Vol. 47, 1891, p. 457.
- [19] U.S. Patent 575,002 *Illuminant for Incandescent Lamps* by A. de Lodyguine. Application on 4 January 1893
- [20] “Alexander de Lodyguine - Google keresés”. *google.com*.
- [21] Hans-Christian Rohde: *Die Göbel-Legende – Der Kampf um die Erfindung der Glühlampe*. Zu Klampen, Springe 2007, ISBN 978-3-86674-006-8 (german, dissertation)
- [22] “Patent no. 3738. Filing year 1874: Electric Light”. Library and Archives Canada. Retrieved 17 June 2013.
- [23] “Henry Woodward and Mathew Evans Lamp retrieved 2010 February 16”. *frogn.net*.
- [24] Swan K R Sir Joseph Swan and the Invention of the Incandescent Electric Lamp. 1946 Longmans, Green and Co. Pp 21–25.
- [25] “Lamp Inventors 1880–1940: Carbon Filament Incandescent” Smithsonian National Museum of American History. Retrieved 6 February 2008.
- [26] R.C. Chirnside. Sir Joseph Wilson Swan FRS – The Literary and Philosophical Society of Newcastle upon Tyne 1979.
- [27] “The Savoy Theatre”, *The Times*, 3 October 1881
- [28] U.S. Patent 0,214,636.
- [29] Burns, Elmer Ellsworth (1910). *The story of great inventions*. Harper & Brothers. Retrieved September 12, 2013.
- [30] Paul Israel, *Edison: a Life of Invention*, Wiley (1998), page 186.
- [31] “Thomas Edison: Original Letters and Primary Sources”. Shapell Manuscript Foundation.
- [32] U.S. Patent 0,223,898 granted 27 January 1880
- [33] Levy, Joel (2003). *Really useful: the origins of everyday things*. New York: Firefly Books. p. 124. ISBN 9781552976227.
- [34] Belyk, Robert C. *Great Shipwrecks of the Pacific Coast*. New York: Wiley, 2001. ISBN 0-471-38420-8
- [35] Jehl, Francis *Menlo Park reminiscences : written in Edison's restored Menlo Park laboratory*, Henry Ford Museum and Greenfield Village, Whitefish, Mass, Kessinger Publishing, 1 July 2002, page 564
- [36] Dalton, Anthony *A long, dangerous coastline : shipwreck tales from Alaska to California* Heritage House Publishing Company, 1 Feb 2011 - 128 pages
- [37] U.S. Patent 252, 386 *Process OF Manufacturing Carbons*. by Lewis H. Latimer. Application on February 19, 1881
- [38] Fouché, Rayvon, *Black Inventors in the Age of Segregation: Granville T. Woods, Lewis H. Latimer, and Shelby J. Davidson.* (Johns Hopkins University Press, Baltimore & London, 2003, pp. 115–116. ISBN 0-8018-7319-3
- [39] Consol. Elec. Light Co v. McKeesport Light Co, 40 F. 21 (C.C.W.D. Pa. 1889) aff'd, 159 U.S. 465, 16 S. Ct. 75, 40 L. Ed. 221 (1895).
- [40] Mills, Allan (June 2013). “The Nernst Lamp. Electrical Conductivity in Non-Metallic Materials”. *eRittenhouse* **24** (1).
- [41] “Walther Nernst Chronology”. *nernst.de*. Retrieved 18 Jan 2015.
- [42] “The History of Tungsram” (PDF). Archived from the original (PDF) on 30 May 2005.
- [43] “Information About Old Light Bulbs”. *eHow UK*.
- [44] “Ganz and Tungsram - the 20th century”. Archived from the original on 30 March 2009.
- [45] *Incandescent Lamps, Publication Number TP-110*, General Electric Company, Nela Park, Cleveland, OH (1964) pg. 3
- [46] Raymond Kane, Heinz Sell *Revolution in lamps: a chronicle of 50 years of progress (2nd ed.)*, The Fairmont Press, Inc. 2001 ISBN 0-88173-378-4 page 37, table 2-1
- [47] IEEE Std. 100 definition of “luminous efficacy” pg. 647
- [48] Klipstein, Donald L. (1996). “The Great Internet Light Bulb Book, Part I”. Retrieved 16 April 2006.
- [49] See luminosity function.
- [50] “WebCite query result”. *webcitation.org*.
- [51] “WebCite query result”. *webcitation.org*.
- [52] “WebCite query result”. *webcitation.org*.
- [53] Prof. Peter Lund, Helsinki University of Technology, on p. C5 in Helsingin Sanomat 23 Oct. 2007.
- [54] “WebCite query result”. *webcitation.org*.
- [55] “Incandescent Bulbs Still Suck: Why the Bulb as Heater Argument Falls Short”. *TreeHugger*.
- [56] “Is Environmentalism Really Working?: Germany's Eco-Trap”. *Der Spiegel*. 17 March 2010. Retrieved 20 March 2011.
- [57] “It's lights out for traditional light bulbs”. *USA Today*. 16 December 2007.
- [58] Department of Climate Change and Energy Efficiency (2 February 2011). “Lighting – Think Change”. Retrieved 15 May 2011.

- [59] “Incandescent Bulbs Return to the Cutting Edge”. *The New York Times*. 6 July 2009.
- [60] Daley, Dan (February 2008). “Incandescent’s Not-So-Dim Future”. *Projection, Lights & Staging News* **09** (1) (Timeless Communications Corp). p. 46. Retrieved 17 June 2013.
- [61] “GE Announces Advancement in Incandescent Technology; New High-Efficiency Lamps Targeted for Market by 2010”. *Business Wire*. 23 February 2007. Retrieved 18 June 2013.
- [62] Hamilton, Tyler (22 April 2009). “Why the brightest idea needs tinkering”. *Toronto Star*. Retrieved 18 June 2013.
- [63] Rahim, Saqib (28 June 2010). “The Incandescent Bulb Heads Offstage After Century-Long Performance”. *The New York Times*. Retrieved 18 June 2013.
- [64] “Revolutionary tungsten photonic crystal could provide more power for electrical devices”. Sandia National Laboratories. 7 July 2003. Retrieved 18 June 2013.
- [65] Broydo Vestel, Leora (6 July 2009). “Incandescent Bulbs Return to the Cutting Edge”. *The New York Times*. Retrieved 6 July 2009.
- [66] “Lamp Material Information Sheet – Incandescent Lamp” (PDF). Retrieved 20 May 2013.
- [67] uigi.com – Argon (Ar) Properties, Uses, Applications Argon Gas and Liquid Argon, 2007
- [68] “The Chemistry of Artificial Lighting Devices”. *google.cz*.
- [69] “When do light bulbs typically “burn out”- when you turn them on, off, or while on? Explain your answer. - Homework Help - eNotes.com”. *eNotes*.
- [70] I. C. S. Reference Library Volume 4B, Scranton, International Textbook Company, 1908, no ISBN
- [71] “GE Tantalum Filament 25W of American Design”. Museum of Electric Lamp Technology. Retrieved 17 June 2013.
- [72] “The Osmium Filament Lamp”. *frognet.net*.
- [73] Chapter 2 *The Potassium Secret Behind Tungsten Wire Production*
- [74] John Kaufman (ed.), *IES Lighting Handbook 1981 Reference Volume*, Illuminating Engineering Society of North America, New York, 1981 ISBN 0-87995-007-2 page 8-6
- [75] Burgin. *Lighting Research and Technology 1984* 16.2 61–72
- [76] Hunt, Robert (2001–2006). “Glass Blowing for Vacuum Devices – Lamp Autopsy”. Teralab. Retrieved 2 May 2007.
- [77] Lipstein, Don. “Premium Fill Gasses”. Retrieved 13 October 2011.
- [78] Toshiba Lighting Products Miniature Lamp Characteristics. Retrieved 23 March 2008.
- [79] John Kaufman (ed.), *IES Lighting Handbook 1981 Reference Volume*, Illuminating Engineering Society of North America, New York, 1981 ISBN 0-87995-007-2 page 8-9
- [80] IEC 60064 Tungsten filament lamps for domestic and similar general lighting purposes.
- [81] John Kaufman (ed.), *IES Lighting Handbook 1981 Reference Volume*, Illuminating Engineering Society of North America, New York, 1981 ISBN 0-87995-007-2 page 8-10
- [82] “Incandescent Arc Lamps”. Museum of Electric Lamp Technology. 2004. Retrieved 17 June 2013.
- [83] G. Arncliffe Percival, *The Electric Lamp Industry*, Sir Isaac Pitman and Sons, Ltd. London, 1920 pp. 73–74, available from the Internet Archive
- [84] S. G. Starling, *An Introduction to Technical Electricity*, McMillan and Co., Ltd., London 1920, pp. 97–98, available at the Internet Archive, good schematic diagram of the *Pointolite lamp*
- [85] Wells, Quentin (2012), *Smart Grid Home*, p. 163, ISBN 1111318514, retrieved 8 November 2012
- [86] Roy, Kamesh (2006), *Illuminating Engineering*, p. 30, ISBN 8170088984, retrieved 7 November 2012
- [87] “Light and Lighting Fun Facts”. *donkclipstein.com*.
- [88] Edison’s research team was aware of the large negative temperature coefficient of resistance of possible lamp filament materials and worked extensively during the period 1878–1879 on devising an automatic regulator or *ballast* to stabilize current. It wasn’t until 1879 that it was realized a self-limiting lamp could be built. See Friedel and Israel *Edison’s Electric Light* pages 29–31
- [89] page 23, 24
- [90] “Identification Guide”. KO Lighting. Retrieved 18 June 2013.
- [91] “Lighting Resources”. *GE Lighting North America*.
- [92] Osram IRC Saver calculator
- [93] “Single-Ended Halogen Bases”. Bulbster.com. Retrieved 17 June 2013.
- [94] Donald G. Fink and H. Wayne Beatty, *Standard Handbook for Electrical Engineers, Eleventh Edition*, McGraw-Hill, New York, 1978, ISBN 0-07-020974-X, pg 22–8
- [95] Krajewski, Markus (24 Sep 2014). “The Great Lightbulb Conspiracy”. *IEEE Spectrum*. IEEE. Retrieved 10 Nov 2014.
- [96] “Tests shine light on the secret of the Livermore light bulb”. 6 February 2011.
- [97] “Watts Up? – A parting look at lighting”. Archived from the original on 7 February 2009.

2.12 External links

- Light Source Spectra 60 W-100 W Incandescent light bulb spectra, from Cornell University Program of Computer Graphics
- Bulb Museum

Chapter 3

Halogen lamp



A halogen lamp operating in its fitting with the protecting glass removed



A Halogen lamp behind a round UV filter. A separate filter is included with some halogen light fixtures to remove UV light.

A **halogen lamp**, also known as a **tungsten halogen**, **quartz-halogen** or **quartz iodine lamp**, is an incandescent lamp that has a small amount of a halogen such as iodine or bromine added. The combination of the halogen gas and the tungsten filament produces a **halogen cycle** chemical reaction which redeposits evaporated tungsten back onto the filament, increasing its life and maintaining the clarity of the envelope. Because of this, a halogen lamp can be operated at a higher temperature than a standard gas-filled lamp of similar power and op-



Xenon Halogen Lamp (105 W) for replacement purposes with an E27 screw base

erating life, producing light of a higher luminous efficacy and color temperature. The small size of halogen lamps permits their use in compact optical systems for projectors and illumination.

3.1 History

A carbon filament lamp using chlorine to prevent darkening of the envelope was patented^[1] in 1882, and chlorine-

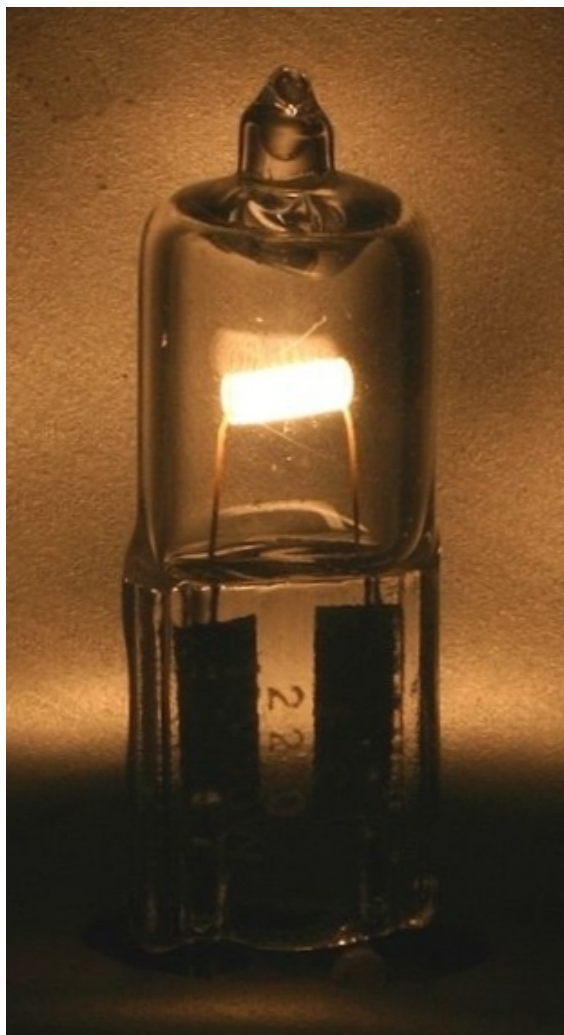

A close-up of a halogen lamp

filled “NoVak” lamps were marketed in 1892.^[2] The use of iodine was proposed in a 1933 patent,^[3] which also described the cyclic redeposition of tungsten back onto the filament. In 1959, General Electric patented^[3] a practical lamp using iodine.^[4]

3.2 Halogen cycle

In ordinary incandescent lamps, evaporated tungsten mostly deposits onto the inner surface of the bulb, causing the bulb to blacken and the filament to grow increasingly weak until it eventually breaks. The halogen, however, sets up a reversible chemical reaction cycle with this evaporated tungsten. The halogen cycle keeps the bulb clean and causes the light output to remain almost constant throughout the bulb’s life. At moderate temperatures the halogen reacts with the evaporating tungsten, the halide formed being moved around in the inert gas filling. At some point, however, it will reach higher temperature regions within the bulb where it then dissociates, releasing tungsten back onto the filament and freeing the halo-

gen to repeat the process. The overall bulb envelope temperature must be significantly higher than in conventional incandescent lamps for this reaction to succeed, however.

The bulb must be made of fused silica (quartz) or a high-melting-point glass (such as aluminosilicate glass). Since quartz is very strong, the gas pressure can be higher,^[5] which reduces the rate of evaporation of the filament, permitting it to run a higher temperature (and so luminous efficacy) for the same average life. The tungsten released in hotter regions does not generally redeposit where it came from, so the hotter parts of the filament eventually thin out and fail.

Quartz iodine lamps, using elemental iodine, were the first commercial halogen lamps launched by GE in 1959.^{[6][7]} Quite soon, bromine was found to have advantages, but was not used in elemental form. Certain hydrocarbon bromine compounds gave good results.^{[8][9]} Regeneration of the filament is also possible with fluorine, but its chemical reactivity is so great that other parts of the lamp are attacked.^{[8][10]} The halogen is normally mixed with a noble gas, often krypton or xenon.^[11] The first lamps used only tungsten for filament supports, but some designs use molybdenum — an example being the molybdenum shield in the H4 twin filament headlight for the European Asymmetric Passing Beam.

For a fixed power and life, the luminous efficacy of all incandescent lamps is greatest at a particular design voltage. Halogen lamps made for 12 to 24 volt operation have good light outputs, and the very compact filaments are particularly beneficial for optical control (see picture). The range of multifaceted reflector “MR” lamps of 20-50 watts were originally conceived for the projection of 8 mm film, but are now widely used for display lighting and in the home. More recently, wider beam versions have become available designed for direct use on supply voltages of 120 or 230 V.

3.3 Effect of voltage on performance

Tungsten halogen lamps behave in a similar manner to other incandescent lamps when run on a different voltage. However the light output is reported as proportional to V^3 , and the luminous efficacy proportional to $V^{1.3}$.^[12] The normal relationship regarding the lifetime is that it is proportional to V^{-14} . For example, a bulb operated at 5% higher than its design voltage would produce about 15% more light, and the luminous efficacy would be about 6.5% higher, but would be expected to have only half the rated life.

Halogen lamps are manufactured with enough halogen to match the rate of tungsten evaporation at their design voltage. Increasing the applied voltage increases the rate of evaporation, so at some point there may be insufficient

halogen and the lamp goes black. Over-voltage operation is not generally recommended. With a reduced voltage the evaporation is lower and there may be too much halogen, which can lead to abnormal failure. At much lower voltages, the bulb temperature may be too low to support the halogen cycle, but by this time the evaporation rate is too low for the bulb to blacken significantly. There are many situations where halogen lamps are dimmed successfully. However, lamp life may not be extended as much as predicted. The life span on dimming depends on lamp construction, the halogen additive used and whether dimming is normally expected for this type.

3.4 Spectrum

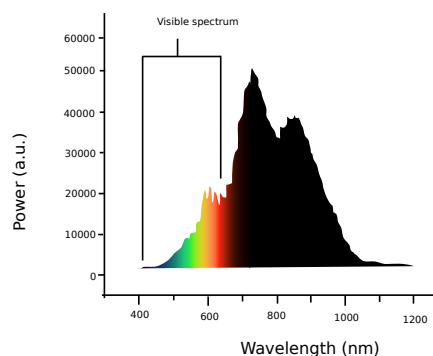

A technical diagram depicting the power of a halogen light at various wavelengths. An overlay of the visible light spectrum can be seen along the left side.

Like all incandescent light bulbs, a halogen lamp produces a continuous spectrum of light, from near ultraviolet to deep into the infrared.^[13] Since the lamp filament can operate at a higher temperature than a non-halogen lamp, the spectrum is shifted toward blue, producing light with a higher effective color temperature.

High temperature filaments emit some energy in the UV region. Small amounts of other elements can be mixed into the quartz, so that the doped quartz (or selective optical coating) blocks harmful UV radiation. Hard glass blocks UV and has been used extensively for the bulbs of car headlights.^[14] Alternatively, the halogen lamp can be mounted inside an outer bulb, similar to an ordinary incandescent lamp, which also reduces the risks from the high bulb temperature. Undoped quartz halogen lamps are used in some scientific, medical and dental instruments as a UV-B source.

3.5 Safety

Halogen lamps get hotter than regular incandescent lamps because the heat is concentrated on a smaller envelope

surface, and because the surface is closer to the filament. This high temperature is essential to their operation. Because the halogen lamp operates at very high temperatures, it can pose fire and burn hazards. In Australia, numerous house fires each year are attributed to ceiling-mounted halogen downlights.^{[15][16]} The Western Australia Department of Fire and Emergency Services recommends that home owners consider instead using compact fluorescent lamps or light emitting diode lamps because they produce less heat.^[17] Some safety codes now require halogen bulbs to be protected by a grid or grille, especially for high power (1–2 kW) bulbs used in theatre, or by the glass and metal housing of the fixture to prevent ignition of draperies or flammable objects in contact with the lamp.

To reduce unintentional ultraviolet (UV) exposure, and to contain hot bulb fragments in the event of explosive bulb failure, general-purpose lamps usually have a UV-absorbing glass filter over or around the bulb. Alternatively, lamp bulbs may be doped or coated to filter out the UV radiation. With adequate filtering, a halogen lamp exposes users to less UV than a standard incandescent lamp producing the same effective level of illumination without filtering.

3.5.1 Handling precautions

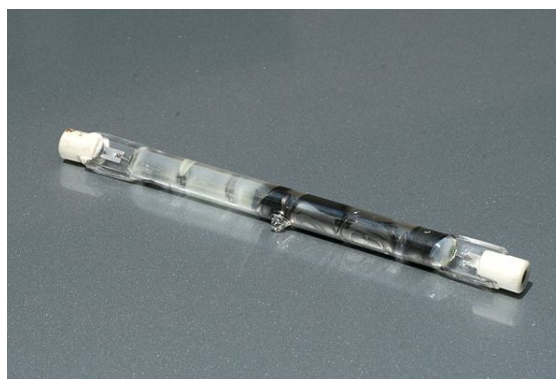

A burned out halogen light bulb

Any surface contamination, notably the oil from human fingertips, can damage the quartz envelope when it is heated. Contaminants will create a hot spot on the bulb surface when the lamp is turned on. This extreme, localized heat causes the quartz to change from its vitreous form into a weaker, crystalline form that leaks gas. This weakening may also cause the bulb to form a bubble, weakening it and leading to its explosion.^[18] Consequently, manufacturers recommend that quartz lamps should be handled without touching the clear quartz, either by using a clean paper towel or carefully holding the porcelain base. If the quartz is contaminated in any way, it must be thoroughly cleaned with denatured alcohol and dried before use.

3.6 Applications



Medical halogen penlight to observe pupillary light reflex

Halogen headlamps are used in many automobiles. Halogen floodlights for outdoor lighting systems as well as for watercraft are also manufactured for commercial and recreational use. They are now also used in desktop lamps.

Tungsten-halogen lamps are frequently used as a near-infrared light source in *Infrared spectroscopy*.

Halogen lamps were used on the *Times Square Ball* from 1999 to 2006. However, from 2007 onwards, the halogen lamps were replaced with LED lights, both to reduce electrical costs, and due to the much longer potential lifespan (about ten times longer for LED over incandescent). The year numerals that light up when the ball reaches the bottom used halogen lighting for the last time for the 2009 ball drop. It was announced on the Times Square website that the year numerals for the 2010 ball drop would use LED lights.^[19]

3.6.1 Automotive

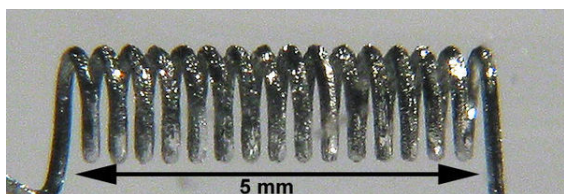

A close-up of a tungsten filament of a halogen car lamp after several hundred hours of use

Main article: Automotive lamp types

Tungsten-halogen lamps have been commonly used as the light sources in automobile headlamps, but are increasing being replaced by Xenon and LED lights.

3.6.2 Architectural

- Linear in various sizes and power
 - R7S: linear halogen lamp measuring 118mm or 78mm. Also known as a double ended halogen lamp. There are also less common 189mm, 254mm and 331mm R7S lamps.

- Dichroic and plain reflector spots. Higher efficiency versions using infrared reflective coating (IRC) technology are 40% more efficient than standard low voltage halogen lamps

3.6.3 Cooking

Halogen lamps are used as the heating element in a halogen oven.

3.6.4 Home use

Halogen multifaceted reflector bulbs are widely available. The most common format is MR16, which is available in 10–50 W power ratings (150–800 lumens).^[20] Low voltage lamps use the MR16 and similar bi-pin bases, whereas mains voltage lamps use the same caps as normal mains tungsten filament lamps, or a special GU10/GZ10 base. The GU10/GZ10 bases are shaped to prevent dichroic reflector lamps being used in luminaires intended for aluminised reflector lamps, which could cause overheating of the fitting. Higher efficiency LED versions of all of these lamps are now available, but these have widely varying light output and quality.

With the help of some companies such as Philips and Osram Sylvania, halogen bulbs have been made for standard household fittings, and can replace banned incandescent light bulbs of low luminous efficacy.^{[21][22][23]}

Tubular lamps with electrical contacts at each end are now being used in standalone lamps and household fixtures. These come in various lengths and wattages (50–300 W).

3.6.5 Stage lighting

Tungsten halogen lamps are used in the majority of theatrical and studio (film and television) fixtures, including Ellipsoidal Reflector Spotlights and Fresnels. PAR Cans are also predominately tungsten halogen.

3.6.6 Specialized

Projection lamps are used in motion-picture and slide projectors for homes and small office or school use. The compact size of the halogen lamp permits a reasonable size for portable projectors, although heat-absorbing filters must be placed between the lamp and the film to prevent melting. Halogen lamps are sometimes used for inspection lights and microscope stage illuminators. Halogen lamps were used for early flat-screen LCD backlighting, but other types of lamps are now used.

3.7 Disposal

Halogen lamps do not contain any mercury. General Electric claims that none of the materials making up their halogen lamps would cause the lamps to be classified as hazardous waste.^[24]

3.8 External links

- [Halogen Lamp Resources](#) Halogen Lamp Resources

3.9 See also

- [Bi-pin connector for base designations GY6.35, G8, etc.](#)
- [FEL lamp](#)
- [Lamp base for other bases](#)
- [List of light sources](#)

3.10 References

- [1] US 254780
- [2] Harold Wallace *A Different Kind of Chemistry: A History of Tungsten Halogen Lamps, IEEE Industry Applications Magazine* Nov/Dec 2001, p. 11
- [3] US 2883571
- [4] Raymond Kane, Heinz Sell *Revolution in lamps: a chronicle of 50 years of progress (2nd ed.)*, The Fairmont Press, Inc. 2001 ISBN 0-88173-378-4 page 75
- [5] Some lamps have as much as 15 times atmospheric pressure when cold, and some lamps increase pressure five-fold at operating temperature. Kane and Sell 2001, page 76–77
- [6] Zubler and Mosby *Illuminating Engineering* 1959 54.734
- [7] <http://home.frognet/~{e}jcov/newhalogen.html>
- [8] Burgin and Edwards *Lighting Research and Technology* 1970 2.2. 95–108
- [9] T'Jampens and van der Weijer *Philips Technical Review* 1966 27.173
- [10] Schroder *Philips Technical Review* 1965 26.116
- [11] Häussinger, Peter; Glatthaar, Reinhard; Rhode, Wilhelm; Kick, Helmut; Benkmann, Christian; Weber, Josef; Wunschel, Hans-Jörg; Stenke, Viktor; Leicht, Edith; Stenger, Hermann (2002). "Noble gases". *Ullmann's Encyclopedia of Industrial Chemistry*. Wiley. doi:10.1002/14356007.a17_485.
- [12] Neumann *Lichttechnik* 1969 21 6 63A
- [13] [Tungsten-halogen lamp information at Karl Zeiss Online Campus site](#) (accessed Nov. 2 2010)
- [14] Burgin *Lighting Research and Technology* 1984 16. 2 71
- [15] [Thousands at risk from halogen-light death traps at The Sunday Age site](#) (accessed 22 Dec. 2012)
- [16] [Halogen down light fire safety at Fire and Rescue NSW site](#) (accessed 22 Dec. 2012)
- [17] [Downlights at Western Australia Department of Fire and Emergency Services site](#) (accessed 22 Dec. 2012)
- [18] Kremer, Jonathan Z. "Types of Light Bulbs and Their Uses" Megavolt, section "Halogen", Accessed May 26, 2011.
- [19] "Times Square Alliance - New Year's Eve - 2010 Widgets".
- [20] "Replace Inefficient MR16 Halogen Lamps with LEDs". *Maxim*. September 25, 2007.
- [21] <http://www.consumersearch.com/light-bulbs/philips-halogen-energy-saver>
- [22] http://www.lighting.philips.com/us_en/products/halogen/index.php?main=us_en_consumer_lighting&parent=7593748565&id=us_en_products&lang=en
- [23] <http://www.sylvania.com/en-us/products/halogen/Pages/default.aspx>
- [24] http://www.geconsumerandindustrial.com/environmentalinfo/documents/msds/msds_quartzline_lamps.pdf General Electric Lamp Material Information Sheet

Chapter 4

Fused quartz

Not to be confused with shocked quartz.

Fused quartz or **fused silica** is glass consisting of silica



A fused quartz sphere manufactured for use in a gyroscope in the Gravity Probe B experiment. It is one of the most accurate spheres ever manufactured, deviating from a perfect sphere by no more than 40 atoms of thickness. It is thought that only neutron stars are smoother.

in amorphous (non-crystalline) form. It differs from traditional glasses in containing no other ingredients, which are typically added to glass to lower the melt temperature. Fused silica, therefore, has high working and melting temperatures. The optical and thermal properties of fused quartz are superior to those of other types of glass due to its purity. For these reasons, it finds use in situations such as semiconductor fabrication and laboratory equipment. It has better ultraviolet transmission than most other glasses, and so is used to make lenses and other optics for the ultraviolet spectrum. Its low coefficient of thermal expansion also makes it a useful material for precision mirror substrates.^[1]

4.1 Production

4.1.1 Feedstock

Fused quartz is produced by fusing (melting) high-purity silica sand, which consists of quartz crystals. Quartz contains only silicon and oxygen, although commercial quartz glass often contains impurities. The most domi-

nant impurities are aluminium and titanium.^[2]

4.1.2 Fusion

Melting is effected at approximately 2000 °C using either an electrically heated furnace (electrically fused) or a gas/oxygen-fuelled furnace (flame fused). Fused silica can be made from almost any silicon-rich chemical precursor, usually using a continuous process which involves flame oxidation of volatile silicon compounds to silicon dioxide, and thermal fusion of the resulting dust (although there are alternative processes). This results in a transparent glass with an ultra-high purity and improved optical transmission in the deep ultraviolet. One common method involves adding silicon tetrachloride to a hydrogen–oxygen flame, however use of this precursor results in environmentally unfriendly by-products including chlorine and hydrochloric acid. To eliminate these by-products, new processes have been developed using an alternative feedstock, which has also resulted in a higher purity fused silica with further improved deep ultraviolet transmission.

4.1.3 Product quality

Fused quartz is normally transparent, the process of fusion results in a material that is translucent. The material can however appear opaque owing to the presence small air bubbles trapped within the material. The water content (and therefore infrared transmission of fused quartz and fused silica) is determined by the manufacturing process. Flame fused material always has a higher water content due to the combination of the hydrocarbons and oxygen fuelling the furnace forming hydroxyl [OH] groups within the material. An IR grade material typically has an [OH] content of <10 parts per million.

4.2 Applications

Most of the applications of fused silica exploit its wide transparency range, which extends from the UV to the

near IR. Fused silica is the key starting material for optical fiber, used for telecommunications.

Because of its strength and high melting point (compared to ordinary glass), fused silica is used as an envelope for halogen lamps and high-intensity discharge lamps, which must operate at a high envelope temperature to achieve their combination of high brightness and long life. Vacuum tubes with silica envelopes allowed for radiation-cooling by incandescent anodes.

The combination of strength, thermal stability, and UV transparency makes it an excellent substrate for projection masks for photolithography.

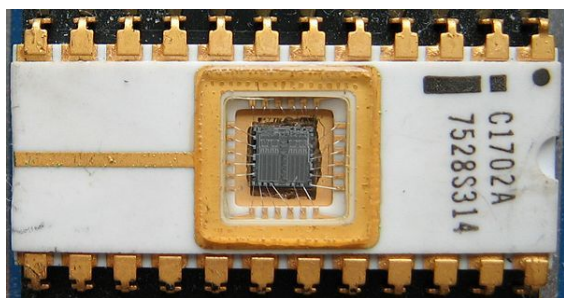

An EPROM with fused quartz window in the top of the package

Its UV transparency also finds uses in the semiconductor industry; an EPROM, or *erasable programmable read only memory*, is a type of memory chip that retains its data when its power supply is switched off, but which can be erased by exposure to strong ultraviolet light. EPROMs are recognizable by the transparent fused quartz window which sits on top of the package, through which the silicon chip is visible, and which permits exposure to UV light during erasing.

Due to the thermal stability and composition it is used in semiconductor fabrication furnaces.

Fused quartz has nearly ideal properties for fabricating first surface mirrors such as those used in telescopes. The material behaves in a predictable way and allows the optical fabricator to put a very smooth polish onto the surface and produce the desired figure with fewer testing iterations. In some instances, a high-purity UV grade of fused quartz has been used to make several of the individual uncoated lens elements of special purpose lenses including the Zeiss 105mm f/4.3 UV Sonnar, a lens formerly made for the Hasselblad camera, and the Nikon UV-Nikkor 105mm f/4.5 (presently sold as the Nikon PF10545MF-UV) lens. These lenses are used for UV photography, as the quartz glass has a lower extinction rate than lens made with more common flint or crown glass formulas.

4.2.1 Refractory material applications

Fused silica as an industrial raw material is used to make various refractory shapes such as crucibles, trays,

shrouds, and rollers for many high-temperature thermal processes including steelmaking, investment casting, and glass manufacture. Refractory shapes made from fused silica have excellent thermal shock resistance and are chemically inert to most elements and compounds including virtually all acids, regardless of concentration, except hydrofluoric acid which is very reactive even in fairly low concentrations. Translucent fused silica tubes are commonly used to sheath electric elements in room heaters, industrial furnaces and other similar applications.

Owing to its low mechanical damping at ordinary temperatures, it is used for high-Q resonators, in particular, for wine-glass resonator of hemispherical resonator gyro (HRG).^{[3][4]}

Quartz glassware is occasionally used in chemistry laboratories when standard borosilicate glass cannot withstand high temperatures; it is more commonly found as a very basic element, such as a tube in a furnace, or as a flask, the elements in direct exposure to the heat.

4.3 Physical properties

The extremely low coefficient of thermal expansion, about $5.5 \times 10^{-7}/^{\circ}\text{C}$ (20–320 °C), accounts for its remarkable ability to undergo large, rapid temperature changes without cracking (see thermal shock).

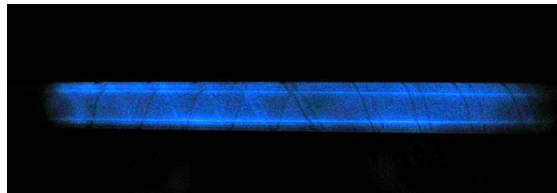

Phosphorescence in fused quartz from an extremely intense pulse of ultraviolet light, centered at 170 nm, in a flashtube.

Fused quartz is prone to phosphorescence and "solarisation" (purplish discoloration) under intense UV illumination, as is often seen in flashtubes. "UV grade" synthetic fused silica (sold under various tradenames including "HPFS", "Spectrosil" and "Suprasil") has a very low metallic impurity content making it transparent deeper into the ultraviolet. An optic with a thickness of 1 cm will have a transmittance of about 50% at a wavelength of 170 nm, which drops to only a few percent at 160 nm. However, its infrared transmission is limited by strong water absorptions at 2.2 μm and 2.7 μm .

"Infrared grade" fused quartz (tradenames "Infrasil", "Vitreosil IR" and others) which is electrically fused, has a greater presence of metallic impurities, limiting its UV transmittance wavelength to around 250 nm, but a much lower water content, leading to excellent infrared transmission up to 3.6 μm wavelength. All grades of transparent fused quartz/fused silica have nearly identical physical

properties.

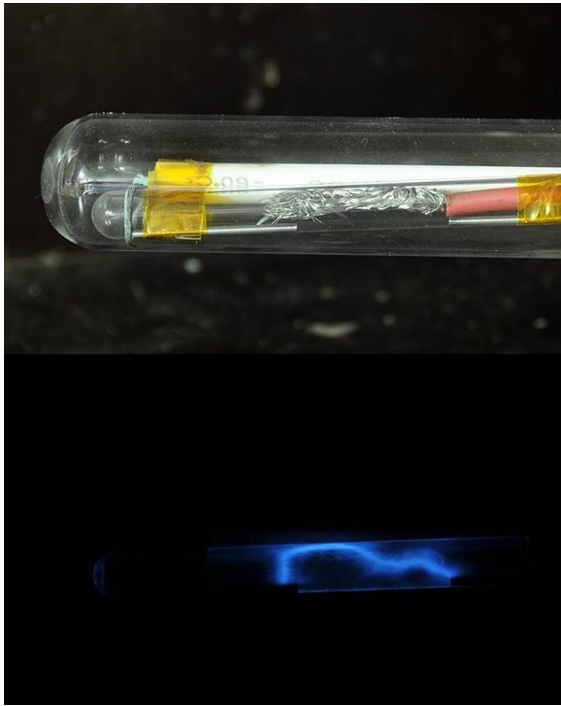

Phosphorescence of the quartz ignition tube of an air-gap flash.

4.4 Optical properties

The optical dispersion of fused silica can be approximated by the following Sellmeier equation:^[5]

$$\varepsilon = n^2 = 1 + \frac{0.6961663\lambda^2}{\lambda^2 - 0.0684043^2} + \frac{0.4079426\lambda^2}{\lambda^2 - 0.1162414^2} + \frac{0.897479\lambda^2}{\lambda^2 - 9.896161^2},$$

where the wavelength λ is measured in micrometers. This equation is valid between 0.21 and 3.71 micrometers and at 20 °C.^[5] Its validity was confirmed for wavelengths up to 6.7 μm .^[6] Experimental data for the real (refractive index) and imaginary (absorption index) parts of the complex refractive index of fused quartz reported in the literature over the spectral range from 30 nm to 1000 μm has been reviewed by Kitamura et al.^[6] and are available online.

4.5 Typical properties of clear fused silica

- Density: 2.203 g/cm³
- Hardness: 5.3–6.5 (Mohs scale), 8.8 GPa
- Tensile strength: 48.3 MPa
- Compressive strength: >1.1 GPa

- Bulk modulus: ~37 GPa
- Rigidity modulus: 31 GPa
- Young's modulus: 71.7 GPa
- Poisson's ratio: 0.17
- Lamé elastic constants: $\lambda=15.87$ GPa, $\mu=31.26$ GPa
- Coefficient of thermal expansion: $5.5 \times 10^{-7}/^\circ\text{C}$ (average from 20 °C to 320 °C)
- Thermal conductivity: 1.3 W/(m·K)
- Specific heat capacity: 45.3 J/(mol·K)
- Softening point: c. 1665 °C
- Annealing point: c. 1140 °C
- Strain point: 1070 °C
- Electrical resistivity: $>10^{18}$ $\Omega\cdot\text{m}$
- Dielectric constant: 3.75 at 20 °C 1 MHz
- Dielectric loss factor: less than 0.0004 at 20 °C 1 MHz
- Index of refraction: at 587.6 nm (n_d): 1.4585
- Change of refractive index with temperature (0 to 700 °C): $1.28 \times 10^{-5}/^\circ\text{C}$ (between 20 and 30 °C)^[5]
- Strain-optic coefficients: $p_{11}=0.113$, $p_{12}=0.252$.
- Hamaker constant: $A=6.5 \times 10^{-20}$ J.
- Dielectric strength: 250–400 kV/cm at 20 °C^[7]
- Surface Tension: .300 N/m at 1800 - 2400 °C^[8]

4.6 See also

- Vycor
- Structure of liquids and glasses

4.7 References

- [1] De Jong, Bernard H. W. S.; Beerkens, Ruud G. C.; Van Nijnatten, Peter A. (2000). "Ullmann's Encyclopedia of Industrial Chemistry". doi:10.1002/14356007.a12_365. ISBN 3-527-30673-0. |chapter= ignored (help)
- [2] *Chemical purity of fused quartz / fused silica*, www.heraeus-quarzglas.com
- [3] An Overview of MEMS Inertial Sensing Technology, February 1, 2003

- [4] Penn, Steven D.; Harry, Gregory M.; Gretarsson, Andri M.; Kittelberger, Scott E.; Saulson, Peter R.; Schiller, John J.; Smith, Joshua R.; Swords, Sol O. (2001). “High quality factor measured in fused silica”. *Review of Scientific Instruments* **72** (9): 3670. doi:10.1063/1.1394183.
- [5] Malitson, I. H. (October 1965). “Interspecimen Comparison of the Refractive Index of Fused Silica” (PDF). *Journal of the Optical Society of America* **55** (10): 1205–1209. doi:10.1364/JOSA.55.001205. Retrieved 2014-07-12.
- [6] Kitamura, Rei; Pilon, Laurent; Jonasz, Mirosław (2007-11-19). “Optical Constants of Silica Glass From Extreme Ultraviolet to Far Infrared at Near Room Temperatures” (PDF). *Applied Optics* **46** (33): 8118–8133. doi:10.1364/AO.46.008118. Retrieved 2014-07-12.
- [7] Fused silica datapage
- [8] Surface tension and viscosity measurement of optical glasses using a scanning CO2 laser

4.8 External links

- “Frozen Eye to Bring New Worlds into View” *Popular Mechanics*, June 1931 General Electric, West Lynn Massachusetts Labs work on large fused quartz blocks

Chapter 5

LED lamp



An assortment of LED lamps commercially available as of 2010 as replacements for screw-in bulbs, including floodlight fixtures (left), reading light (center), household lamps (center right and bottom), and low-power accent light (right) applications



LED light bulb to replace G24 compact fluorescent lamp



LED spotlight using 60 individual diodes for mains voltage power

An **LED lamp** is a light-emitting diode (LED) product that is assembled into a *lamp* (or *light bulb*) for use in lighting fixtures. LED lamps have a lifespan and electrical efficiency that is several times better than incandescent lamps, and significantly better than most fluorescent lamps, with some chips able to emit more than 100 lumens per watt. The LED lamp market is projected to grow by more than twelve-fold over the next decade, from \$2 billion in the beginning of 2014 to \$25 billion in 2023, a compound annual growth rate (CAGR) of 25%.^[1]

Like incandescent lamps and unlike most fluorescent lamps (e.g. tubes and compact fluorescent lamps or

CFLs), LEDs come to full brightness without need for a warm-up time; the life of fluorescent lighting is also reduced by frequent switching on and off. Initial cost of LED is usually higher. Degradation of LED dye and packaging materials reduces light output to some extent over time.

Some LED lamps are made to be a directly compatible drop-in replacement for incandescent or fluorescent lamps. An LED lamp packaging may show the **lumen** output, power consumption in watts, color temperature in kelvins or description (e.g. "warm white"), operating temperature range, and sometimes the equivalent wattage of an incandescent lamp of similar luminous output.

Most LEDs do not emit light in all directions, and their directional characteristics affect the design of lamps. Although through the progression of time, omnidirectional lamps are becoming more common, allowing for 360° light spread. The **light output** of single LEDs is less than that of incandescent and compact fluorescent lamps; in most applications multiple LEDs are used to form a lamp, although high-power versions (see below) are becoming available.

LED chips need controlled direct current (DC) electrical power; an appropriate circuit is required to convert alternating current from the supply to the regulated low

voltage direct current used by the LEDs. LEDs are adversely affected by high temperature, so LED lamps typically include heat dissipation elements such as heat sinks and cooling fins.

5.1 Technology overview



Dropped ceiling with LED lamps

General-purpose lighting needs white light. LEDs emit light in a very narrow band of wavelengths, emitting light of a color characteristic of the energy bandgap of the semiconductor material used to make the LED. To emit white light from LEDs requires either mixing light from red, green, and blue LEDs, or using a phosphor to convert some of the light to other colors.

One method (RGB or trichromatic white LEDs) uses multiple LED chips, each emitting a different wavelength, in close proximity to generate white light. This allows the intensity of each LED to be adjusted to change the overall color.

The second method uses LEDs in conjunction with a phosphor. The CRI (color rendering index) value can range from less than 70 to over 90, and color temperatures in the range of 2700 K (matching incandescent lamps) up to 7000 K are available.

5.2 Application

A significant difference from other light sources is that the light is more directional, i.e., emitted as a narrower beam. LED lamps are used for both general and special-purpose lighting. Where colored light is needed, LEDs that inherently emit light of a single color require no energy-absorbing filters.

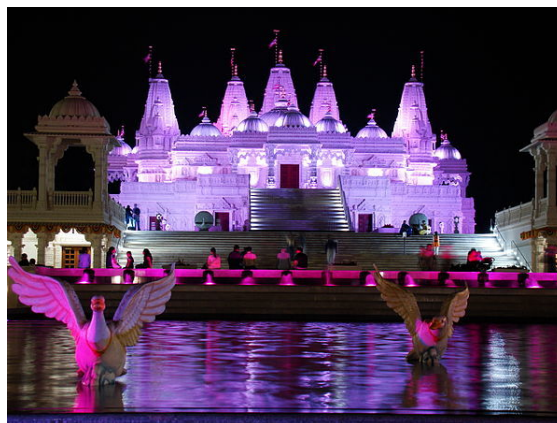

BAPS Shri Swaminarayan Mandir Atlanta Illumination with color mixing LED fixtures



Computer-led LED lighting allows enhancement of unique qualities of paintings in the National Museum in Warsaw^[2]

White-light LED lamps have longer life expectancy and higher efficiency (more light for the same electricity) than most other lighting when used at the proper temperature. LED sources are compact, which gives flexibility in designing lighting fixtures and good control over the distribution of light with small reflectors or lenses. Because of the small size of LEDs, control of the spatial distribution of illumination is extremely flexible,^[3] and the light output and spatial distribution of an LED array can be controlled with no efficiency loss.

LEDs using the color-mixing principle can emit a wide range of colors by changing the proportions of light generated in each primary color. This allows full color mixing in lamps with LEDs of different colors.^[4] Unlike other lighting technologies, LED emission tends to be directional (or at least lambertian), which can be either

advantageous or disadvantageous, depending on requirements. For applications where non-directional light is required, either a diffuser is used, or multiple individual LED emitters are used to emit in different directions.

5.3 Household LED lamps

5.3.1 Replacement for existing lighting



Disassembled LED-light bulb with driver circuit board and Edison screw

Lamp sizes and bases

LED lamps are made of arrays of **SMD** modules that replace screw-in incandescent or compact fluorescent light bulbs, mostly replacing incandescent bulbs rated from 5 to 60 watts. Such lamps are made with standard light bulb connections and shapes, such as an Edison screw base, an MR16 shape with a bi-pin base, or a GU5.3 (bi-pin cap) or GU10 (bayonet fitting) and are made compatible with the voltage supplied to the sockets. They include driver circuitry to rectify the AC power and convert the voltage to an appropriate value, usually Switched-mode power supplies.

As of 2010 some LED lamps replaced higher wattage bulbs; for example, one manufacturer claimed a 16-watt LED bulb was as bright as a 150 W halogen lamp.^[5] A standard general-purpose incandescent bulb emits light at an efficiency of about 14 to 17 lumens/W depending on its size and voltage. According to the European Union standard, an energy-efficient bulb that claims to be the equivalent of a 60 W tungsten bulb must have a minimum light output of 806 lumens.^[6]



A selection of consumer LED bulbs available in 2012 as drop-in replacements for incandescent bulbs in screw-type sockets

Some models of LED bulbs are compatible with dimmers as used for incandescent lamps. LED lamps often have directional light characteristics. The lamps have declined in cost to between US\$10 to \$50 each as of 2012. These bulbs are more power-efficient than compact fluorescent bulbs^[7] and offer lifespans of 30,000 or more hours, reduced if operated at a higher temperature than specified. Incandescent bulbs have a typical life of 1,000 hours, and compact fluorescents about 8,000 hours. The bulbs maintain output light intensity well over their lifetimes. Energy Star specifications require the bulbs to typically drop less than 10% after 6,000 or more hours of operation, and in the worst case not more than 15%.^[8] LED lamps are available with a variety of color properties. The purchase price is higher than most other, but the higher efficiency may make total cost of ownership (purchase price plus cost of electricity and changing bulbs) lower.^[9]



High-power LED light bulb

Several companies offer LED lamps for general lighting purposes. The technology is improving rapidly and new energy-efficient consumer LED lamps are available.^[10]

LED lamps are close to being adopted as the mainstream light source because of the falling prices and because 40 and 60 watt incandescent bulbs are being phased out.^[11] In the U.S. the Energy Independence and Security Act of 2007 effectively bans the manufacturing and importing of most current incandescent light bulbs. LED bulbs have decreased substantially in pricing and many varieties are sold with subsidized prices from local utilities.^[12]

LED tube lamps

LED tube lights are designed to physically fit in fixtures intended for fluorescent tubes. Some LED tube lamps are intended to be a drop-in replacement into existing fixtures. Others require rewiring of the fixtures to remove the ballast. An LED tube lamp generally uses many individual LEDs which are directional. Fluorescent lamps emit light all the way around the lamp. Most LED tube lights available can be used in place of T8, T10, or T12 tube designations, in lengths of 2, 4, 6, and 8 feet.



A 17 W tube of LEDs which has the same intensity as a 45 W fluorescent tube

5.3.2 Lighting designed for LEDs



LED-wall lamp

Newer light fittings designed for LED lamps, or indeed with long-lived LEDs built-in, have been coming into use as the need for compatibility with existing fittings diminishes. Such lighting does not require each bulb to contain circuitry to operate from mains voltage.

5.4 Specialty uses



LED Flashlight replacement bulb (left), with tungsten equivalent (right)

White LED lamps have achieved market dominance in applications where high efficiency is important at

low power levels. Some of these applications include flashlights, solar-powered garden or walkway lights, and bicycle lights. Monochromatic (colored) LED lamps are now commercially used for traffic signal lamps, where the ability to emit bright monochromatic light is a desired feature, and in strings of holiday lights.

5.5 Comparison to other lighting technologies

See *luminous efficacy* for an efficiency chart comparing various technologies.

- **Incandescent lamps** (light bulbs) generate light by passing electric current through a resistive filament, thereby heating the filament to a very high temperature so that it glows and emits visible light over a broad range of wavelengths. Incandescent sources yield a “warm” yellow or white color quality depending on the filament operating temperature. Incandescent lamps emit 98% of the energy input as heat.^[13] A 100 W light bulb for 120 V operation emits about 1,700 lumens, about 17 lumens/W;^[14] for 230 V bulbs the figures are 1340 lm and 13.4 lm/W.^[15] Incandescent lamps are relatively inexpensive to make. The typical lifespan of an AC incandescent lamp is 750 to 1,000 hours.^{[16][17]} They work well with dimmers. Most older light fixtures are designed for the size and shape of these traditional bulbs. In the U.S. the regular sockets are E26 and E11, and E27 and E14 in some European countries.
- **Fluorescent lamps** work by passing electricity through mercury vapor, which in turn emits ultraviolet light. The ultraviolet light is then absorbed by a phosphor coating inside the lamp, causing it to glow, or fluoresce. Conventional linear fluorescent lamps have life spans around 20,000 and 30,000 hours based on 3 hours per cycle according to lamps NLPPI reviewed in 2006. Induction fluorescent relies on electromagnetism rather than the cathodes used to start conventional linear fluorescent. The newer rare earth triphosphor blend linear fluorescent lamps made by Osram, Philips, Crompton and others have a life expectancy greater than 40,000 hours, if coupled with a warm-start electronic ballast. The life expectancy depends on the number of on/off cycles, and is lower if the light is cycled often. The ballast-lamp combined system efficacy for then current linear fluorescent systems in 1998 as tested by NLPPI ranged from 80 to 90 lm/W.^[18] For comparison, general household LED bulbs available in 2011 emit 64 lumens/W.^[19]
- **Compact fluorescent lamps'** specified lifespan typically ranges from 6,000 hours to 15,000 hours.^[16]

- Electricity prices vary state to state and are customer dependent. Generally commercial (10.3 cent/kWh) and industrial (6.8 cent/kWh) electricity prices are lower than residential (12.3 cent/kWh) due to fewer transmission losses.^[20]

In keeping with the long life claimed for LED lamps, long warranties are offered. One manufacturer warrants lamps for professional use, depending upon type, for periods of (defined) “normal use” ranging from 1 year or 2,000 hours (whichever comes first) to 5 years or 20,000 hours.^[28] A typical domestic LED lamp is stated to have an “average life” of 15,000 hours (15 years at 3 hours/day), and to support 50,000 switch cycles.^[29]

5.5.1 Energy Star qualification

Energy Star is an international standard for energy efficient consumer products.^{[30][31]} Devices carrying the Energy Star service mark generally use 20–30% less energy than required by US standards.^[32]

Energy Star LED qualifications:

- Reduces energy costs — uses at least 75% less energy than incandescent lighting, saving on operating expenses.
- Reduces maintenance costs — lasts 35 to 50 times longer than incandescent lighting and about 2 to 5 times longer than fluorescent lighting. No bulb-replacements, no ladders, no ongoing disposal program.
- Reduces cooling costs — LEDs produce very little heat.
- Is guaranteed — comes with a minimum three-year warranty — far beyond the industry standard.
- Offers convenient features — available with dimming on some indoor models and automatic daylight shut-off and motion sensors on some outdoor models.
- Is durable — won’t break like a bulb.

To qualify for Energy Star certification, LED lighting products must pass a variety of tests to prove that the products will display the following characteristics:

- Brightness is equal to or greater than existing lighting technologies (incandescent or fluorescent) and light is well distributed over the area lighted by the fixture.
- Light output remains constant over time, only decreasing towards the end of the rated lifetime (at least 35,000 hours or 12 years based on use of 8 hours per day).

- Excellent color quality. The shade of white light appears clear and consistent over time.
- Efficiency is as good as or better than fluorescent lighting.
- Light comes on instantly when turned on.
- No flicker when dimmed.
- No off-state power draw. The fixture does not use power when it is turned off, with the exception of external controls, whose power should not exceed 0.5 watts in the off state.

5.6 Limitations

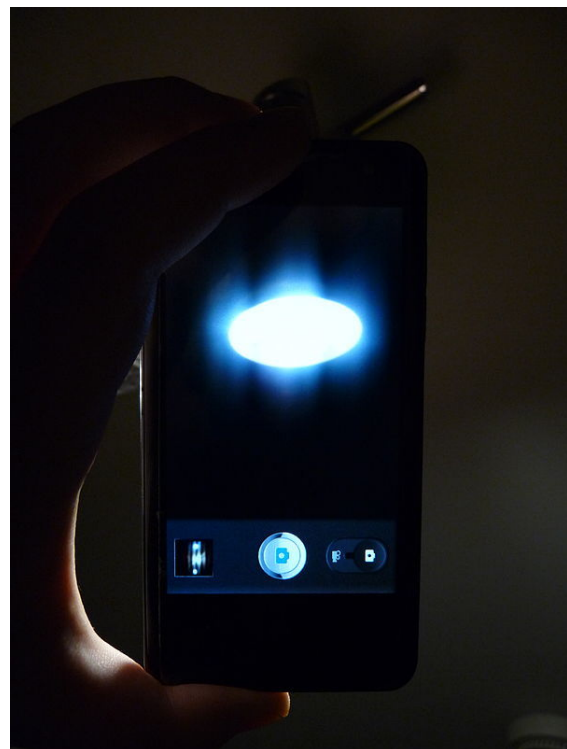

Camera of mobile phone can detect flickering of LED light bulb

Color rendition is not identical to incandescent lamps. A measurement unit called **CRI** is used to express how the light source’s ability to render the eight color sample chips compare to a reference on a scale from 0 to 100.^[33] LEDs with CRI below 75 are not recommended for use in indoor lighting.^[34]

LED efficiency and life span drop at higher temperatures, which limits the power that can be used in lamps that physically replace existing filament and compact fluorescent types. Thermal management of high-power LEDs is a significant factor in design of solid state lighting equipment.

LED lamps are sensitive to excessive heat, like most solid state electronic components. LED lamps should be

checked for compatibility for use in totally or partially enclosed fixtures before installation since heat build-up could cause lamp failure and/or fire.

LED lamps may flicker. The extent of flicker is based on the quality of the DC power supply built into the lamp structure, usually located in the lamp base.

Depending on the design of the lamp, the LED lamp may be sensitive to electrical surges. This is generally not an issue with incandescents, but can be an issue with LED and compact fluorescent bulbs. Power circuits that supply LED lamps can be protected from electrical surges through the use of surge protection devices.

The long life of LEDs, expected to be about 50 times that of the most common incandescent bulbs and significantly longer than fluorescent types, is advantageous for users but will affect manufacturers as it reduces the market for replacements in the distant future.^[35]

5.6.1 Efficiency droop

The term “efficiency droop” refers to the decrease in luminous efficacy of LEDs as the electrical current increases above tens of milliamps (mA). Instead of increasing current levels, luminance is usually increased by combining multiple LEDs in one bulb. Solving the problem of efficiency droop would mean that household LED light bulbs would need fewer LEDs, which would significantly reduce costs.

In addition to being less efficient, operating LEDs at higher electrical currents creates higher heat levels which compromise the lifetime of the LED. Because of this increased heating at higher currents, high-brightness LEDs have an industry standard of operating at only 350 mA. 350 mA is a good compromise between light output, efficiency, and longevity.^{[36][37][38][39]}

Early suspicions were that the LED droop was caused by elevated temperatures. Scientists proved the opposite to be true that, although the life of the LED would be shortened, elevated temperatures actually improved the efficiency of the LED.^[40] The mechanism causing efficiency droop was identified in 2007 as Auger recombination, which was taken with mixed reaction.^[39] In 2013, a study conclusively identified Auger recombination as the cause of efficiency droop.^[41]

5.7 Development and adoption history

The first LEDs were developed in the early 1960s, however, they were low-powered and only produced light in the low, red frequencies of the spectrum. The first high-brightness blue LED was demonstrated by Shuji Nakamura of Nichia Corporation in 1994.^[42] The exist-

tence of blue LEDs and high-efficiency LEDs quickly led to the development of the first white LED, which employed a phosphor coating to mix down-converted yellow light with blue to produce light that appears white.^[43] Isamu Akasaki, Hiroshi Amano and Nakamura were later awarded the 2014 Nobel prize in physics for the invention of the blue LED.^[44]

The Energy Independence and Security Act (EISA) of 2007 authorized the Department of Energy (DOE) to establish the Bright Tomorrow Lighting Prize competition, known as the “L Prize”, the first government-sponsored technology competition designed to challenge industry to develop replacements for 60 W incandescent lamps and PAR 38 halogen lamps. The EISA legislation established basic requirements and prize amounts for each of the two competition categories, and authorized up to \$20 million in cash prizes.^[45] The competition also included the possibility for winners to obtain federal purchasing agreements, utility programs, and other incentives. In May 2008, they announced details of the competition and technical requirements for each category. Lighting products meeting the competition requirements could use just 17% of the energy used by most incandescent lamps in use today. That same year the DOE also launched the Energy Star program for solid-state lighting products. The EISA legislation also authorized an additional L Prize program for developing a new “21st Century Lamp”.

Philips Lighting ceased research on compact fluorescents in 2008 and began devoting the bulk of its research and development budget to solid-state lighting.^[35] On 24 September 2009, Philips Lighting North America became the first to submit lamps in the category to replace the standard 60 W A-19 “Edison screw fixture” light bulb,^[9] with a design based on their earlier “AmbientLED” consumer product. On 3 August 2011, DOE awarded the prize in the 60 W replacement category to a Philips’ LED lamp after 18 months of extensive testing.^[46]

Early LED lamps varied greatly in chromaticity from the incandescent lamps they were replacing. A standard was developed, ANSI C78.377-2008, that specified the recommended color ranges for solid-state lighting products using cool to warm white LEDs with various correlated color temperatures.^[47] In June 2008, NIST announced the first two standards for solid-state lighting in the United States. These standards detail performance specifications for LED light sources and prescribe test methods for solid-state lighting products.

Also in 2008 in the United States and Canada, the Energy Star program began to label lamps that meet a set of standards for starting time, life expectancy, color, and consistency of performance. The intent of the program is to reduce consumer concerns due to variable quality of products, by providing transparency and standards for the labeling and usability of products available in the market.^[48] Energy Star Light Bulbs for Consumers is a

resource for finding and comparing Energy Star qualified lamps. A similar program in the United Kingdom (run by the Energy Saving Trust) was launched to identify lighting products that meet energy conservation and performance guidelines.^[49]

The Illuminating Engineering Society of North America (IESNA) published a documentary **standard LM-79**, which describes the methods for testing solid-state lighting products for their light output (lumens), efficacy (lumens per watt) and chromaticity.

In January 2009, it was reported that researchers at Cambridge University had developed an LED bulb that costs £2 (about \$3 U.S.), is 12 times as energy efficient as a tungsten bulb, and lasts for 100,000 hours.^[50] Honeywell Electrical Devices and Systems (ED&S) recommend world wide usage of LED lighting as it is energy efficient and can help save the climate.^[51]

5.7.1 Examples of early adoption



LEDs as Christmas illumination in Viborg, Denmark

In 2008 Sentry Equipment Corporation in Oconomowoc, Wisconsin, USA, was able to light its new factory interior and exterior almost solely with LEDs. Initial cost was three times more than a traditional mix of incandescent and fluorescent lamps, but the extra cost was recovered within two years via electricity savings, and the lamps should not need replacing for 20 years.^[35] In 2009 the Manapakkam, Chennai office of the Indian IT company, iGate, spent ₹3,700,000 (US\$80,000) to light 57,000 sq ft (5,300 m²) of office space with LEDs. The firm expected the new lighting to pay for itself fully within 5 years.^[52]

In 2009 the exceptionally large Christmas tree standing in front of the Turku Cathedral in Finland was hung with 710 LED bulbs, each using 2 watts. It has been calculated that these LED lamps paid for themselves in three and a half years, even though the lights run for only 48 days per year.^[53]

In 2009 a new highway (A29) was inaugurated in Aveiro, Portugal, it included the first European public LED-based

lighting highway.^[54]

By 2010 mass installations of LED lighting for commercial and public uses were becoming common. LED lamps were used for a number of demonstration projects for outdoor lighting and LED street lights. The United States Department of Energy made several reports available on the results of many pilot projects for municipal outdoor lighting,^[55] and many additional streetlight and municipal outdoor lighting projects soon followed.^[56]

5.8 See also

- LED display
- LED headlamp
- LED Filament
- List of emerging technologies
- List of light sources
- Lux
- Photometry (optics)
- Radiation angle
- Solar lamp
- Spectrometer

5.9 References

- [1] Jacques, Carole (28 January 2014) LED Lighting Market to Grow Over 12-Fold to \$25 Billion in 2023, Lux Research
- [2] “Warsaw Top 10” (PDF). *Warsaw tour Edition nr 5, 2012*. p. 20. Retrieved 1 March 2013. The National Museum in Warsaw is also one of the most modern in Europe. (...) The LED system allows to adjust the light to every painting so that its unique qualities are enhanced.
- [3] Moreno, Ivan; Avendaño-Alejo, Maximino; Tzonchev, Rumen I. (2006). “Designing light-emitting diode arrays for uniform near-field irradiance” (PDF). *Applied Optics* **45** (10): 2265–2272. Bibcode:2006ApOpt..45.2265M. doi:10.1364/AO.45.002265. PMID 16607994.
- [4] Moreno, Ivan; Contreras, Ulises (2007). “Color distribution from multicolor LED arrays”. *Optics Express* **15** (6): 3607–18. Bibcode:2007OExpr..15.3607M. doi:10.1364/OE.15.003607. PMID 19532605.
- [5] Commercially available 150W Halogen Equivalent PAR38 (240V). Ledlightingsupplier.co.uk. Retrieved 2 June 2012.
- [6] Lonsdale, Sarah (7 July 2010). “Green property: energy-efficient bulbs”. *The Daily Telegraph* (London). Retrieved 8 June 2011.

- [7] Elisabeth Rosenthal and Felicity Barringer, "Green Promise Seen in Switch to LED Lighting", *The New York Times*, 29 May 2009
- [8] "Integral LED Lamps Criteria Development" (PDF).
- [9] Taub, Eric; leora Broydo Vestel (24 September 2009). "Build a Better Bulb for a \$10 Million Prize". *New York Times*. Retrieved 6 February 2010.
- [10] Eric A. Taub, "LED Bulbs for the Home Near the Marketplace", *The New York Times*, 16 May 2010; see also Matthew L. Wald, *New York Times Green Blog*, "An LED That Mimics an Old Standby", 24 June 2010,
- [11] Philips Flattens the Light Bulb, Mashable, Pete Pachal, 16 December 2013
- [12] Khuê Trầnled grow light
- [13] Keefe, T.J. (2007). "The Nature of Light". Retrieved 10 September 2009.
- [14] http://books.google.com.au/books?id=-ILFECjG-gC&pg=PA163&dq=120volt+incandescent+efficacy+chart&hl=en&sa=X&ei=W_aaUJPTHpHhiwKt1YCICA&redir_esc=y#v=onepage&q=120%20volt%20incandescent%20efficacy%20chart&f=false
- [15] Vergleich für Osram CLAS A 100 E27 klar, Osram CLAS A FR 100 E27, Philips Standard 100W E27 klar. [ide-alo.de](http://www.ide-alo.de)
- [16] Raatma, Lucia (2010). *Green Living: No Action Too Small*. Compass Point Books. p. 22. ISBN 978-0756542931.
- [17] A Short History of Electric Light, The Incandescent Lamp, 1900 to 1920
- [18] Guide to Selecting Frequently Switched T8 Fluorescent Lamp-Ballast Systems. RPI NLPPIP, April 1998
- [19] "Philips wins Energy Star Award for 800 lumen, 12.5 Watt LED bulb" (PDF). 11 February 2011. Retrieved 21 December 2011.
- [20] "Table 5.6.A. Average Retail Price of Electricity to Ultimate Customers by End-Use Sector (Oct 2013)". .S. Energy Information Administration. Retrieved 30 December 2013.
- [21] "HomeDepot.com: Philips 60-Watt Household Incandescent Light Bulb". Retrieved 26 July 2012.
- [22] "Philips EcoVantage 43-Watt (60-Watt) A19 Soft White Dimmable Light Bulb (4-Pack)". Home Depot. Retrieved 5 November 2013.
- [23] "EcoSmart 60W Equivalent Soft White (2700K) Twister CFL Light Bulb (4-pack)". Retrieved 20 January 2014.
- [24] "60W Equivalent Soft White (2700K) A19 Dimmable LED Light Bulb". Home Depot. Retrieved 8 November 2014.
- [25] "Philips 433227 10.5-watt Slim Style Dimmable A19 LED Light Bulb, Soft White". *Amazon*. Retrieved 6 November 2014.
- [26] "LEDnovation – 9.4 Watt – 60 Watt Equal". Retrieved 6 November 2014.
- [27] "Lightbulbs – LEDs and CFLs offer more choices and savings" (PDF). *ConsumerReports*. 2011. Retrieved 21 January 2014.
- [28] One manufacturer's warranty terms for professional LED lamps
- [29] Specification of a typical domestic 9.5W LED lamp as of November 2013
- [30] "The Clinton Presidency: Protecting Our Environment and Public Health". Retrieved 26 March 2012.
- [31] "History of Energy Star". Retrieved 27 March 2012.
- [32] Alena Tugend (10 May 2008). "If Your Appliances Are Avocado, They're Probably not Green". *New York Times*. Retrieved 29 June 2008.
- [33] Appendix B: Calculating color rendering metrics. lrc.rpi.edu
- [34] ENERGY STAR Program Requirements for Solid State Lighting Luminaires. (PDF) . Retrieved 2 June 2012.
- [35] Fans of L.E.D.'s Say This Bulb's Time Has Come By Eric A. Taub. Published: 28 July 2008 – NY Times
- [36] The LED's dark secret. *EnergyDaily*. Retrieved on 16 March 2012.
- [37] Efremov, A. A.; Bochkareva, N. I.; Gorbunov, R. I.; Lavrinovich, D. A.; Rebane, Y. T.; Tarkhin, D. V.; Shreter, Y. G. (2006). "Effect of the joule heating on the quantum efficiency and choice of thermal conditions for high-power blue InGaN/GaN LEDs". *Semiconductors* **40** (5): 605. doi:10.1134/S1063782606050162.
- [38] Smart Lighting: New LED Drops The 'Droop'. *Sciencedaily.com* (13 January 2009). Retrieved on 16 March 2012.
- [39] Stevenson, Richard (August 2009) The LED's Dark Secret: Solid-state lighting won't supplant the lightbulb until it can overcome the mysterious malady known as droop. *IEEE Spectrum*
- [40] Identifying the Causes of LED Efficiency Droop, By Steven Keeping, Digi-Key Corporation Tech Zone
- [41] Iveland, Justin et al. (23 April 2013). "Cause of LED Efficiency Droop Finally Revealed". *Physical Review Letters*, 2013. *Science Daily*.
- [42] Nakamura, S.; Mukai, T. and Senoh, M. (1994). "Candela-Class High-Brightness InGaN/AlGaIn Double-Heterostructure Blue-Light-Emitting-Diodes". *Appl. Phys. Lett.* **64** (13): 1687. Bibcode:1994ApPhL..64.1687N. doi:10.1063/1.111832.
- [43] 2006 Millennium technology prize awarded to UCSB's Shuji Nakamura. ia.ucsb.edu (June 15, 2006). Retrieved on March 16, 2012.
- [44] "The Nobel Prize in Physics 2014 - Press release". www.nobelprize.org. Retrieved October 7, 2014.

- [45] Progress Alerts – 2010, US Department of Energy
- [46] Department of Energy Announces Philips Lighting North America as Winner of L Prize Competition | Department of Energy. Energy.gov (3 August 2011). Retrieved 2012-06-02.
- [47] American National Standard for Specifications for the Chromaticity of Solid-State Lighting (SSL) Products. Nema.org. Retrieved 2 June 2012.
- [48] *Energy Star Program Requirements for CFLS Partner Commitments*, 4th edition, dated 03/07/08, retrieved 25 June 2008.
- [49] Energy saving lighting. Energysavingtrust.org.uk. Retrieved 18 January 2013.
- [50] Great bright hope to end battle of the light bulbs, The Daily Mail, 29 January 2009
- [51] “Switching to LED is a global task: Honeywell”. 7 June 2012.
- [52] Led’ing the way, Nitya Varadarajan, 5 October 2009
- [53] “Of the top six in Turku, led a move – HS.fi – Domestic”. 19 November 2009. Retrieved 9 January 2012.
- [54] New highway connecting Lisbon to Oporto includes first European LED based lighting in a highway, Aveiro 11 September 2009
- [55] U. S. Department of Energy, Solid-State Lighting GATEWAY Demonstration Results (Retrieved 16 July 2010)
- [56] for example, Seattle: “Seattle Picked to Lead National Effort on LED Street Lights” (Retrieved 16 July 2010); Scottsdale: “LED Streetlight Installation” (Retrieved 2010-07-16); Ann Arbor: LED street lights (Retrieved 2010-07-16)

5.10 Further reading

- E. F. Schubert (2006) *Light Emitting Diodes*, Second edition. Cambridge University Press. ISBN 0-521-86538-7

5.11 External links

- e-lumen.eu – a website from the European Commission about the second generation of energy-saving lightbulbs
- LED Lighting, United States Department of Energy
- Efficient LED lighting in conjunction with low-voltage domestic solar PV and mains, earth.org.uk

Chapter 6

Light-emitting diode

“LED” redirects here. For other uses, see [LED \(disambiguation\)](#).

A **light-emitting diode (LED)** is a two-lead

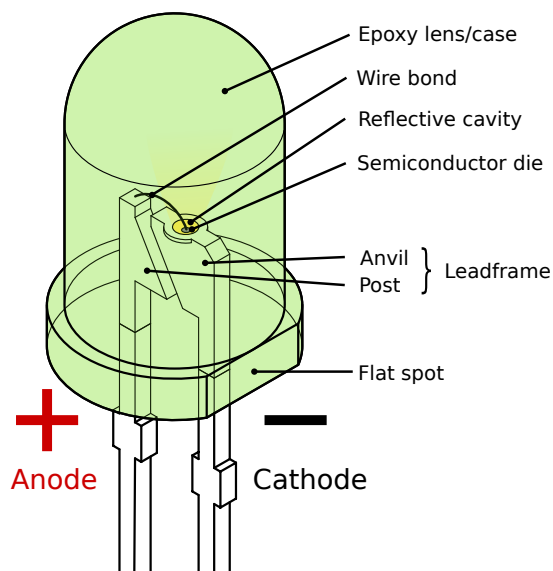

Parts of an LED. Although not directly labeled, the flat bottom surfaces of the anvil and post embedded inside the epoxy act as anchors, to prevent the conductors from being forcefully pulled out from mechanical strain or vibration.

semiconductor light source. It is a pn-junction diode, which emits light when activated.^[4] When a suitable voltage is applied to the leads, electrons are able to recombine with electron holes within the device, releasing energy in the form of photons. This effect is called electroluminescence, and the color of the light (corresponding to the energy of the photon) is determined by the energy band gap of the semiconductor.

An LED is often small in area (less than 1 mm²) and integrated optical components may be used to shape its radiation pattern.^[5]

Appearing as practical electronic components in 1962,^[6] the earliest LEDs emitted low-intensity infrared light. Infrared LEDs are still frequently used as transmitting elements in remote-control circuits, such as those in remote



A bulb-shaped modern retrofit LED lamp with aluminium heat sink, a light diffusing dome and E27 screw base, using a built-in power supply working on mains voltage

controls for a wide variety of consumer electronics. The first visible-light LEDs were also of low intensity, and limited to red. Modern LEDs are available across the visible, ultraviolet, and infrared wavelengths, with very high brightness.

Early LEDs were often used as indicator lamps for electronic devices, replacing small incandescent bulbs. They were soon packaged into numeric readouts in the form of seven-segment displays, and were commonly seen in digital clocks.

Recent developments in LEDs permit them to be used in environmental and task lighting. LEDs have many advantages over incandescent light sources including lower energy consumption, longer lifetime, improved physical robustness, smaller size, and faster switching. Light-emitting diodes are now used in applications as diverse as aviation lighting, automotive headlamps, advertising, general lighting, traffic signals, and camera flashes. However, LEDs powerful enough for room lighting are still relatively expensive, and require more precise current and heat management than compact fluorescent lamp sources of comparable output.

LEDs have allowed new text, video displays, and sensors to be developed, while their high switching rates are also useful in advanced communications technology.

6.1 History

6.1.1 Discoveries and early devices

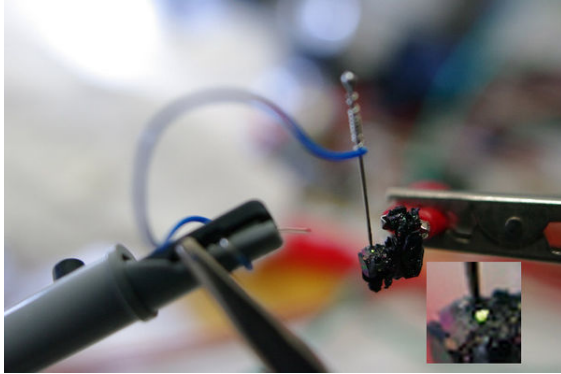

Green electroluminescence from a point contact on a crystal of SiC recreates H. J. Round's original experiment from 1907.

Electroluminescence as a phenomenon was discovered in 1907 by the British experimenter H. J. Round of Marconi Labs, using a crystal of silicon carbide and a cat's-whisker detector.^{[7][8]} Soviet inventor Oleg Losev reported creation of the first LED in 1927.^[9] His research was distributed in Soviet, German and British scientific journals, but no practical use was made of the discovery for several decades.^{[10][11]} Kurt Lehovec, Carl Accardo and Edward Jamgochian, explained these first light-emitting diodes in 1951 using an apparatus employing SiC crystals with a current source of battery or pulse generator and with a comparison to a variant, pure, crystal in 1953.^{[12] [13]}

Rubin Braunstein^[14] of the Radio Corporation of America reported on infrared emission from gallium arsenide (GaAs) and other semiconductor alloys in 1955.^[15] Braunstein observed infrared emission generated by simple diode structures using gallium antimonide (GaSb), GaAs, indium phosphide (InP), and silicon-germanium (SiGe) alloys at room temperature and at 77 kelvins.

In 1957, Braunstein further demonstrated that the rudimentary devices could be used for non-radio communication across a short distance. As noted by Kroemer^[16] Braunstein "... had set up a simple optical communications link: Music emerging from a record player was used via suitable electronics to modulate the forward current of a GaAs diode. The emitted light was detected by a PbS diode some distance away. This signal was fed into an audio amplifier, and played back by a loudspeaker. Intercepting the beam stopped the music. We had a great deal of fun playing with this setup." This setup presaged the use of LEDs for optical communication applications.

In the fall of 1965, while working at Texas Instruments Inc. in Dallas, TX, James R. Biard and Gary Pittman found that gallium arsenide (GaAs) emitted infrared light when electric current was applied. On August 8, 1962, Biard and Pittman filed a patent titled "Semiconductor Radiant Diode" based on their findings, which described

The First LED (Fall 1961)

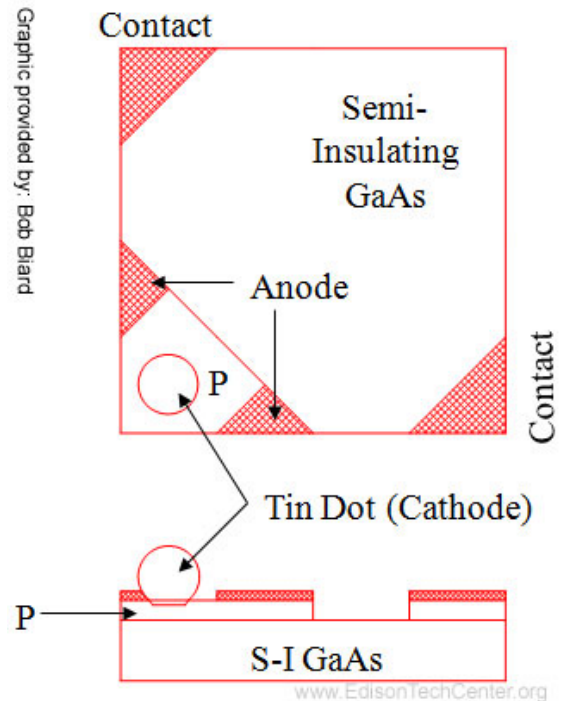

Diagram of a light emitting diode constructed on a zinc diffused area of gallium arsenide semi-insulating substrate^[17]

a zinc diffused p-n junction LED with a spaced cathode contact to allow for efficient emission of infrared light under forward bias.

After establishing the priority of their work based on engineering notebooks predating submissions from G.E. Labs, RCA Research Labs, IBM Research Labs, Bell Labs, and Lincoln Lab at MIT, the U.S. patent office issued the two inventors the patent for the GaAs infrared (IR) light-emitting diode (U.S. Patent US3293513), the first practical LED.^[18] Immediately after filing the patent, Texas Instruments began a project to manufacture infrared diodes. In October 1962, they announced the first LED commercial product (the SNX-100), which employed a pure GaAs crystal to emit a 900 nm light output.

The first visible-spectrum (red) LED was developed in 1962 by Nick Holonyak, Jr., while working at General Electric Company.^[6] Holonyak first reported his LED in the journal *Applied Physics Letters* on the December 1, 1962.^{[19][20]} M. George Craford,^[21] a former graduate student of Holonyak, invented the first yellow LED and improved the brightness of red and red-orange LEDs by a factor of ten in 1972.^[22] In 1976, T. P. Pearsall created the first high-brightness, high-efficiency LEDs for optical fiber telecommunications by inventing new semiconductor materials specifically adapted to optical fiber transmission wavelengths.^[23]

6.1.2 Initial commercial development

The first commercial LEDs were commonly used as replacements for incandescent and neon indicator lamps, and in seven-segment displays,^[24] first in expensive equipment such as laboratory and electronics test equipment, then later in such appliances as TVs, radios, telephones, calculators, as well as watches (see list of signal uses). Until 1968, visible and infrared LEDs were extremely costly, in the order of US\$200 per unit, and so had little practical use.^[25] The Monsanto Company was the first organization to mass-produce visible LEDs, using gallium arsenide phosphide (GaAsP) in 1968 to produce red LEDs suitable for indicators.^[25] Hewlett Packard (HP) introduced LEDs in 1968, initially using GaAsP supplied by Monsanto. These red LEDs were bright enough only for use as indicators, as the light output was not enough to illuminate an area. Readouts in calculators were so small that plastic lenses were built over each digit to make them legible. Later, other colors became widely available and appeared in appliances and equipment. In the 1970s commercially successful LED devices at less than five cents each were produced by Fairchild Optoelectronics. These devices employed compound semiconductor chips fabricated with the planar process invented by Dr. Jean Hoerni at Fairchild Semiconductor.^{[26][27]} The combination of planar processing for chip fabrication and innovative packaging methods enabled the team at Fairchild led by optoelectronics pioneer Thomas Brandt to achieve the needed cost reductions.^[28] These methods continue to be used by LED producers.^[29]



LED display of a TI-30 scientific calculator (ca. 1978), which uses plastic lenses to increase the visible digit size

Most LEDs were made in the very common 5 mm T1 $\frac{3}{4}$ and 3 mm T1 packages, but with rising power output, it has grown increasingly necessary to shed excess heat to maintain reliability,^[30] so more complex packages have been adapted for efficient heat dissipation. Packages for state-of-the-art high-power LEDs bear little resemblance to early LEDs.

6.1.3 The blue and white LED

The first high-brightness blue LED was demonstrated by Shuji Nakamura of Nichia Corporation in 1994 and was based on InGaN.^[31] Parallely Isamu Akasaki and Hiroshi Amano in Nagoya were working on developing the important GaN nucleation on sapphire substrates and the demonstration of p-type doping of GaN. Nakamura, Akasaki and Amano were awarded the Nobel prize in

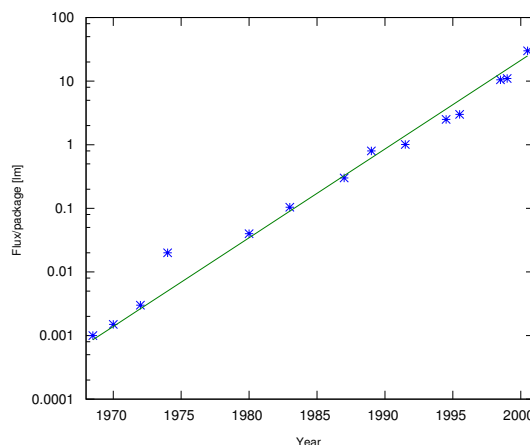

Illustration of Haitz's law. Light output per LED per production year, with a logarithmic scale on the vertical axis

physics for their work.^[32] In 1995, Alberto Barbieri at the Cardiff University Laboratory (GB) investigated the efficiency and reliability of high-brightness LEDs and demonstrated a "transparent contact" LED using indium tin oxide (ITO) on (AlGaInP/GaAs). The existence of blue LEDs and high-efficiency LEDs quickly led to the development of the first white LED, which employed a Y 3Al 5O 12:Ce, or "YAG", phosphor coating to mix down-converted yellow light with blue to produce light that appears white.

In 2001^[33] and 2002,^[34] processes for growing gallium nitride (GaN) LEDs on silicon were successfully demonstrated. In January 2012, Osram demonstrated high-power InGaN LEDs grown on silicon substrates commercially.^[35] It has been speculated that the use of six-inch silicon wafers instead of two-inch sapphire wafers and epitaxy manufacturing processes could reduce production costs by up to 90%.^[36]

6.1.4 Illumination breakthrough

The invention of the blue LED made possible a simple and effective way to generate white light. By coating a blue LED with a phosphor material a portion of the blue light can be converted to green, yellow and red light. This mixture of colored light will be perceived by humans as white light and can therefore be used for general illumination. The first white LEDs were expensive and inefficient. However the development of LED technology has caused their efficiency and light output to rise exponentially, with a doubling occurring approximately every 36 months since the 1960s, in a way similar to Moore's law. This trend is generally attributed to the parallel development of other semiconductor technologies and advances in optics and material science, and has been called Haitz's law after Dr. Roland Haitz.^[37]

As LED materials technology grew more advanced, light output rose, while maintaining efficiency and reliability at acceptable levels. The invention and development of the high-power white-light LED led to use for illumination, and is slowly replacing incandescent and fluorescent lighting^{[38][39]} (see list of illumination applications).

Isamu Akasaki, Hiroshi Amano and Shuji Nakamura have been awarded the Nobel Prize in Physics in 2014. They created the blue LED in the 1990s. Red and green LEDs have been around much longer. The blue LED was final piece of the puzzle to create the RGB LED which can produce any color of light. LEDs can now produce over 300 lumens per watt of electricity, while lasting up to 100,000 hours.^[40]

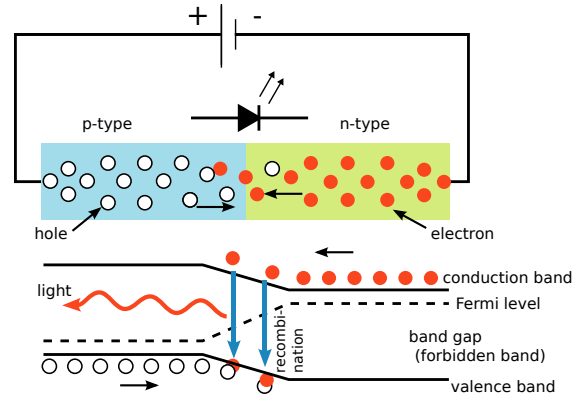

The inner workings of an LED, showing circuit (top) and band diagram (bottom)

6.2 Working

A *P-N junction* can connect the absorbed light energy into its proportional electric current. The same process is reversed here. i.e. the P-N junction emits light when energy is applied on it. This phenomenon is generally called electroluminescence, which can be defined as the emission of light from a semi-conductor under the influence of an electric field. The charge carriers recombine in a forward P-N junction as the electrons cross from the N-region and recombine with the holes existing in the P-region. Free electrons are in the conduction band of energy levels, while holes are in the valence energy band. Thus the energy level of the holes will be lesser than the energy levels of the electrons. Some part of the energy must be dissipated in order to recombine the electrons and the holes. This energy is emitted in the form of heat and light.

The electrons dissipate energy in the form of heat for silicon and germanium diodes. But in *Gallium-Arsenide-phosphorus* (GaAsP) and *Gallium-phosphorus* (GaP) semiconductors, the electrons dissipate energy by emitting photons. If the semiconductor is translucent, the junction becomes the source of light as it is emitted, thus becoming a light emitting diode (LED). But when the junction is reverse biased no light will be produced by the LED, and, on the contrary the device may also get damaged.

6.3 Technology

6.3.1 Physics

The LED consists of a chip of semiconducting material doped with impurities to create a *p-n junction*. As in other diodes, current flows easily from the p-side, or anode, to the n-side, or cathode, but not in the reverse direction. Charge-carriers—electrons and holes—flow into the junction from electrodes with different voltages. When an electron meets a hole, it falls into a lower energy

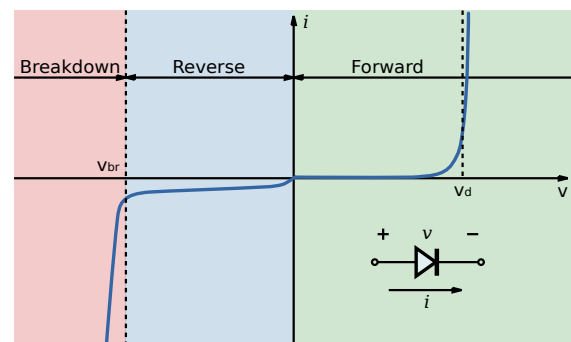

I-V diagram for a diode. An LED will begin to emit light when more than 2 or 3 volts is applied to it. Some external system must control the current through the LED to prevent destruction by overheating.

level and releases energy in the form of a photon.

The wavelength of the light emitted, and thus its color, depends on the band gap energy of the materials forming the *p-n junction*. In silicon or germanium diodes, the electrons and holes usually recombine by a *non-radiative transition*, which produces no optical emission, because these are indirect band gap materials. The materials used for the LED have a direct band gap with energies corresponding to near-infrared, visible, or near-ultraviolet light.

LED development began with infrared and red devices made with gallium arsenide. Advances in materials science have enabled making devices with ever-shorter wavelengths, emitting light in a variety of colors.

LEDs are usually built on an n-type substrate, with an electrode attached to the p-type layer deposited on its surface. P-type substrates, while less common, occur as well. Many commercial LEDs, especially GaN/InGaN, also use sapphire substrate.

Most materials used for LED production have very high refractive indices. This means that much light will be reflected back into the material at the material/air surface interface. Thus, light extraction in LEDs is an important aspect of LED production, subject to much research and

development.

6.3.2 Refractive index

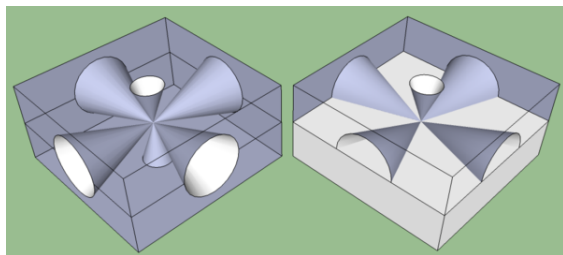

Idealized example of light emission cones in a semiconductor, for a single point-source emission zone. The left illustration is for a fully translucent wafer, while the right illustration shows the half-cones formed when the bottom layer is fully opaque. The light is actually emitted equally in all directions from the point-source, so the areas between the cones shows the large amount of trapped light energy that is wasted as heat.^[41]

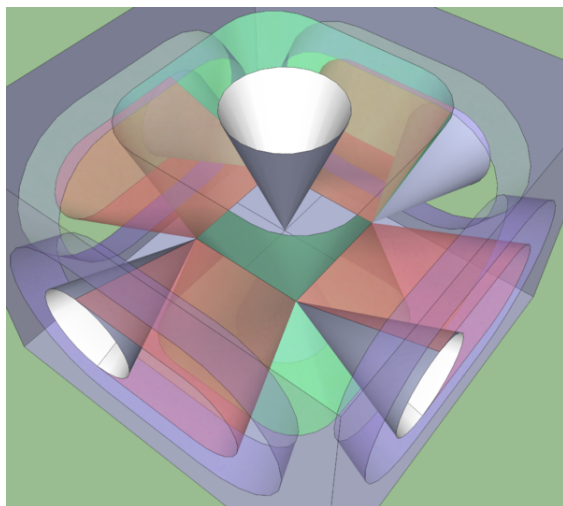

The light emission cones of a real LED wafer are far more complex than a single point-source light emission. The light emission zone is typically a two-dimensional plane between the wafers. Every atom across this plane has an individual set of emission cones. Drawing the billions of overlapping cones is impossible, so this is a simplified diagram showing the extents of all the emission cones combined. The larger side cones are clipped to show the interior features and reduce image complexity; they would extend to the opposite edges of the two-dimensional emission plane.

Bare uncoated semiconductors such as silicon exhibit a very high refractive index relative to open air, which prevents passage of photons arriving at sharp angles relative to the air-contacting surface of the semiconductor. This property affects both the light-emission efficiency of LEDs as well as the light-absorption efficiency of photovoltaic cells. The refractive index of silicon is 3.96 (590 nm),^[42] while air is 1.0002926.^[43]

In general, a flat-surface uncoated LED semiconductor chip will emit light only perpendicular to the semicon-

ductor's surface, and a few degrees to the side, in a cone shape referred to as the *light cone*, *cone of light*,^[44] or the *escape cone*.^[41] The maximum angle of incidence is referred to as the **critical angle**. When this angle is exceeded, photons no longer escape the semiconductor but are instead reflected internally inside the semiconductor crystal as if it were a **mirror**.^[41]

Internal reflections can escape through other crystalline faces, if the incidence angle is low enough and the crystal is sufficiently transparent to not re-absorb the photon emission. But for a simple square LED with 90-degree angled surfaces on all sides, the faces all act as equal angle mirrors. In this case most of the light can not escape and is lost as waste heat in the crystal.^[41]

A convoluted chip surface with angled **facets** similar to a jewel or **fresnel lens** can increase light output by allowing light to be emitted perpendicular to the chip surface while far to the sides of the photon emission point.^[45]

The ideal shape of a semiconductor with maximum light output would be a microsphere with the photon emission occurring at the exact center, with electrodes penetrating to the center to contact at the emission point. All light rays emanating from the center would be perpendicular to the entire surface of the sphere, resulting in no internal reflections. A hemispherical semiconductor would also work, with the flat back-surface serving as a mirror to back-scattered photons.^[46]

Transition coatings

After the doping of the wafer, it is cut apart into individual dies. Each die is commonly called a chip.

Many LED semiconductor chips are encapsulated or potted in clear or colored molded plastic shells. The plastic shell has three purposes:

1. Mounting the semiconductor chip in devices is easier to accomplish.
2. The tiny fragile electrical wiring is physically supported and protected from damage.
3. The plastic acts as a refractive intermediary between the relatively high-index semiconductor and low-index open air.^[47]

The third feature helps to boost the light emission from the semiconductor by acting as a diffusing lens, allowing light to be emitted at a much higher angle of incidence from the light cone than the bare chip is able to emit alone.

6.3.3 Efficiency and operational parameters

Typical indicator LEDs are designed to operate with no more than 30–60 milliwatts (mW) of electrical power.

Around 1999, Philips Lumileds introduced power LEDs capable of continuous use at one watt. These LEDs used much larger semiconductor die sizes to handle the large power inputs. Also, the semiconductor dies were mounted onto metal slugs to allow for heat removal from the LED die.

One of the key advantages of LED-based lighting sources is high luminous efficacy. White LEDs quickly matched and overtook the efficacy of standard incandescent lighting systems. In 2002, Lumileds made five-watt LEDs available with a luminous efficacy of 18–22 lumens per watt (lm/W). For comparison, a conventional incandescent light bulb of 60–100 watts emits around 15 lm/W, and standard fluorescent lights emit up to 100 lm/W.

As of 2012, the Lumiled catalog gives the following as the best efficacy for each color.^[48] The watt-per-watt value is derived using the luminosity function.

In September 2003, a new type of blue LED was demonstrated by the company Cree Inc. to provide 24 mW at 20 milliamperes (mA). This produced a commercially packaged white light giving 65 lm/W at 20 mA, becoming the brightest white LED commercially available at the time, and more than four times as efficient as standard incandescents. In 2006, they demonstrated a prototype with a record white LED luminous efficacy of 131 lm/W at 20 mA. Nichia Corporation has developed a white LED with luminous efficacy of 150 lm/W at a forward current of 20 mA.^[49] Cree's XLamp XM-L LEDs, commercially available in 2011, produce 100 lm/W at their full power of 10 W, and up to 160 lm/W at around 2 W input power. In 2012, Cree announced a white LED giving 254 lm/W,^[50] and 303 lm/W in March 2014.^[51] Practical general lighting needs high-power LEDs, of one watt or more. Typical operating currents for such devices begin at 350 mA.

Note that these efficiencies are for the LED chip only, held at low temperature in a lab. Lighting works at higher temperature and with drive circuit losses, so efficiencies are much lower. United States Department of Energy (DOE) testing of commercial LED lamps designed to replace incandescent lamps or CFLs showed that average efficacy was still about 46 lm/W in 2009 (tested performance ranged from 17 lm/W to 79 lm/W).^[52]

Efficiency droop

Efficiency droop is the decrease (up to 20%) in luminous efficacy of LEDs as the electrical current increases above tens of milliamps (mA).

This effect, first reported in 1999, was initially theorized to be related to elevated temperatures. Scientists proved the opposite to be true that, although the life of an LED would be shortened, the efficiency droop is less severe at elevated temperatures.^[53] The mechanism causing efficiency droop was identified in 2007 as Auger recombina-

tion, which was taken with mixed reaction.^[54] In 2013, a study conclusively identified Auger recombination as the cause of efficiency droop.^[55]

In addition to being less efficient, operating LEDs at higher electrical currents creates higher heat levels which compromise the lifetime of the LED. Because of this increased heating at higher currents, high-brightness LEDs have an industry standard of operating at only 350 mA, which is a compromise between light output, efficiency, and longevity.^{[54][56][57][58]}

Possible solutions Instead of increasing current levels, luminance is usually increased by combining multiple LEDs in one bulb. Solving the problem of efficiency droop would mean that household LED light bulbs would need fewer LEDs, which would significantly reduce costs.

Researchers at the U.S. Naval Research Laboratory have found a way to lessen the efficiency droop. They found that the droop arises from non-radiative Auger recombination of the injected carriers. They created quantum wells with a soft confinement potential to lessen the non-radiative Auger processes.^[59]

Researchers at Taiwan National Central University and Epistar Corp are developing a way to lessen the efficiency droop by using ceramic aluminium nitride (AlN) substrates, which are more thermally conductive than the commercially used sapphire. The higher thermal conductivity reduces self-heating effects.^[60]

6.3.4 Lifetime and failure

Main article: [List of LED failure modes](#)

Solid-state devices such as LEDs are subject to very limited wear and tear if operated at low currents and at low temperatures. Many of the LEDs made in the 1970s and 1980s are still in service in the early 21st century. Typical lifetimes quoted are 25,000 to 100,000 hours, but heat and current settings can extend or shorten this time significantly.^[61]

The most common symptom of LED (and diode laser) failure is the gradual lowering of light output and loss of efficiency. Sudden failures, although rare, can also occur. Early red LEDs were notable for their short service life. With the development of high-power LEDs the devices are subjected to higher junction temperatures and higher current densities than traditional devices. This causes stress on the material and may cause early light-output degradation. To quantitatively classify useful lifetime in a standardized manner it has been suggested to use the terms L70 and L50, which is the time it will take a given LED to reach 70% and 50% light output respectively.^[62]

LED performance is temperature dependent. Most manufacturers' published ratings of LEDs are for an operating

temperature of 25 °C (77 °F). LEDs used outdoors, such as traffic signals or in-pavement signal lights, and that are utilized in climates where the temperature within the light fixture gets very high, could result in low signal intensities or even failure.^[63]

LED light output rises at lower temperatures, leveling off, depending on type, at around -30 °C (-22 °F). Thus, LED technology may be a good replacement in uses such as supermarket freezer lighting^{[64][65][66]} and will last longer than other technologies. Because LEDs emit less heat than incandescent bulbs, they are an energy-efficient technology for uses such as in freezers and refrigerators. However, because they emit little heat, ice and snow may build up on the LED light fixture in colder climates.^[63] Similarly, this lack of waste heat generation has been observed to sometimes cause significant problems with street traffic signals and airport runway lighting in snow-prone areas. In response to this problem, some LED lighting systems have been designed with an added heating circuit at the expense of reduced overall electrical efficiency of the system; additionally, research has been done to develop heat sink technologies that will transfer heat produced within the junction to appropriate areas of the light fixture.^[67]

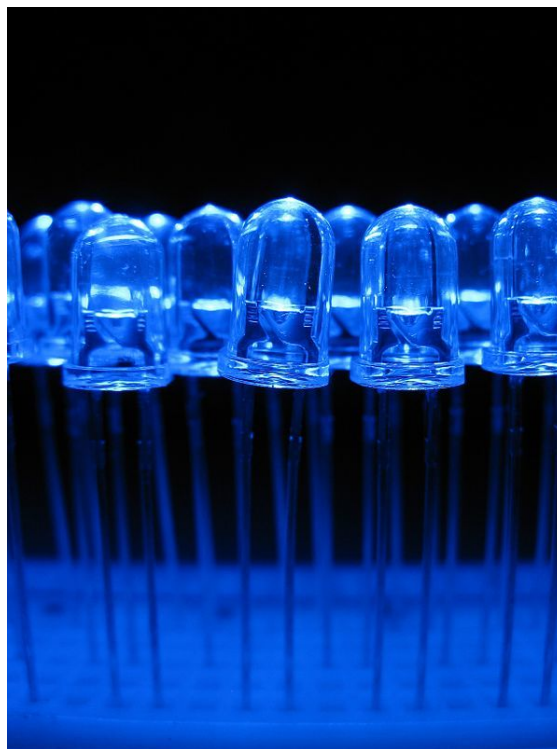

Blue LEDs

6.4 Colors and materials

Conventional LEDs are made from a variety of inorganic semiconductor materials. The following table shows the available colors with wavelength range, voltage drop and material:

6.4.1 RGB

RGB LEDs consist of three LEDs. Each LED actually has one red, one green and one blue light. These three colored LEDs are capable of producing any color.



6.4.2 Ultraviolet and blue LEDs

Current bright blue LEDs are based on the wide band gap between semiconductors GaN (gallium nitride) and In-GaN (indium gallium nitride). They can be added to existing red and green LEDs to produce the impression of white light. Modules combining the three colors are used in big video screens and in adjustable-color fixtures.

The first blue-violet LED using magnesium-doped gallium nitride was made at Stanford University in 1972 by Herb Maruska and Wally Rhines, doctoral students in materials science and engineering.^{[76][77]} At the time Maruska was on leave from RCA Laboratories, where he collaborated with Jacques Pankove on related work. In 1971, the year after Maruska left for Stanford, his RCA colleagues Pankove and Ed Miller demonstrated the first blue electroluminescence from zinc-doped gallium nitride, though the subsequent device Pankove and Miller built, the first actual gallium nitride light-emitting diode, emitted green light.^{[78][79]} In 1974 the U.S. patent office awarded Maruska, Rhines and Stanford professor David Stevenson a patent for their work in 1972 (U.S. Patent US3819974 A) and today magnesium-doping of gallium nitride continues to be the basis for all commercial blue LEDs and laser diodes. These devices built in the early 1970s had too little light output to be of practical use and research into gallium nitride devices slowed. In August 1989, Cree Inc. introduced the first commercially available blue LED based on the indirect bandgap semiconductor, silicon carbide.^[80] SiC LEDs had very low efficiency, no more than about 0.03%, but did emit in the

blue portion of the visible light spectrum.

In the late 1980s, key breakthroughs in GaN epitaxial growth and p-type doping^[81] ushered in the modern era of GaN-based optoelectronic devices. Building upon this foundation, in 1993 high-brightness blue LEDs were demonstrated.^[82] High-brightness blue LEDs invented by Shuji Nakamura of Nichia Corporation using gallium nitride revolutionized LED lighting, making high-power light sources practical.

Nakamura was awarded the 2006 Millennium Technology Prize for his invention.^[83] Nakamura, Hiroshi Amano and Isamu Akasaki were awarded the Nobel Prize in Physics in 2014 for the invention of the blue LED.^{[84][85][86]}

By the late 1990s, blue LEDs became widely available. They have an active region consisting of one or more InGaN quantum wells sandwiched between thicker layers of GaN, called cladding layers. By varying the relative In/Ga fraction in the InGaN quantum wells, the light emission can in theory be varied from violet to amber. Aluminium gallium nitride (AlGaIn) of varying Al/Ga fraction can be used to manufacture the cladding and quantum well layers for ultraviolet LEDs, but these devices have not yet reached the level of efficiency and technological maturity of InGaN/GaN blue/green devices. If un-alloyed GaN is used in this case to form the active quantum well layers, the device will emit near-ultraviolet light with a peak wavelength centred around 365 nm. Green LEDs manufactured from the InGaIn/GaN system are far more efficient and brighter than green LEDs produced with non-nitride material systems, but practical devices still exhibit efficiency too low for high-brightness applications.

With nitrides containing aluminium, most often AlGaIn and AlGaInN, even shorter wavelengths are achievable. Ultraviolet LEDs in a range of wavelengths are becoming available on the market. Near-UV emitters at wavelengths around 375–395 nm are already cheap and often encountered, for example, as black light lamp replacements for inspection of anti-counterfeiting UV watermarks in some documents and paper currencies. Shorter-wavelength diodes, while substantially more expensive, are commercially available for wavelengths down to 240 nm.^[87] As the photosensitivity of microorganisms approximately matches the absorption spectrum of DNA, with a peak at about 260 nm, UV LED emitting at 250–270 nm are to be expected in prospective disinfection and sterilization devices. Recent research has shown that commercially available UVA LEDs (365 nm) are already effective disinfection and sterilization devices.^[88]

Deep-UV wavelengths were obtained in laboratories using aluminium nitride (210 nm),^[72] boron nitride (215 nm)^{[70][71]} and diamond (235 nm).^[69]

6.4.3 White light

There are two primary ways of producing white light-emitting diodes (WLEDs), LEDs that generate high-intensity white light. One is to use individual LEDs that emit three primary colors^[89]—red, green, and blue—and then mix all the colors to form white light. The other is to use a phosphor material to convert monochromatic light from a blue or UV LED to broad-spectrum white light, much in the same way a fluorescent light bulb works.

There are three main methods of mixing colors to produce white light from an LED:

- blue LED + green LED + red LED (color mixing; can be used as backlighting for displays)
- near-UV or UV LED + RGB phosphor (an LED producing light with a wavelength shorter than blue's is used to excite an RGB phosphor)
- blue LED + yellow phosphor (two complementary colors combine to form white light; more efficient than first two methods and more commonly used)^[90]

Because of metamerism, it is possible to have quite different spectra that appear white. However, the appearance of objects illuminated by that light may vary as the spectrum varies.

RGB systems

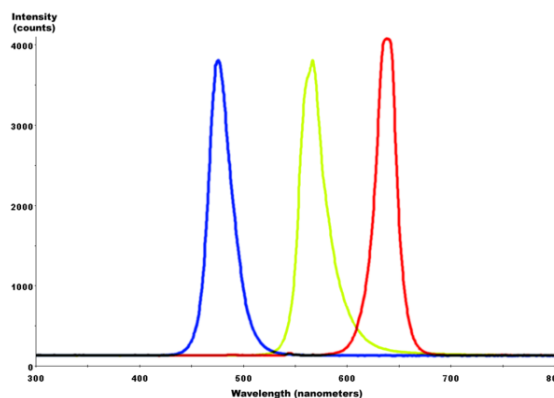

Combined spectral curves for blue, yellow-green, and high-brightness red solid-state semiconductor LEDs. FWHM spectral bandwidth is approximately 24–27 nm for all three colors.

White light can be formed by mixing differently colored lights; the most common method is to use red, green, and blue (RGB). Hence the method is called multi-color white LEDs (sometimes referred to as RGB LEDs). Because these need electronic circuits to control the blending and diffusion of different colors, and because the individual color LEDs typically have slightly different emission patterns (leading to variation of the color depending on direction) even if they are made as a single unit, these are



RGB LED.

seldom used to produce white lighting. Nevertheless, this method is particularly interesting in many uses because of the flexibility of mixing different colors,^[91] and, in principle, this mechanism also has higher quantum efficiency in producing white light.

There are several types of multi-color white LEDs: di-, tri-, and tetrachromatic white LEDs. Several key factors that play among these different methods, include color stability, color rendering capability, and luminous efficacy. Often, higher efficiency will mean lower color rendering, presenting a trade-off between the luminous efficiency and color rendering. For example, the dichromatic white LEDs have the best luminous efficacy (120 lm/W), but the lowest color rendering capability. However, although tetrachromatic white LEDs have excellent color rendering capability, they often have poor luminous efficiency. Trichromatic white LEDs are in between, having both good luminous efficacy (>70 lm/W) and fair color rendering capability.

One of the challenges is the development of more efficient green LEDs. The theoretical maximum for green LEDs is 683 lumens per watt but as of 2010 few green LEDs exceed even 100 lumens per watt. The blue and red LEDs get closer to their theoretical limits.

Multi-color LEDs offer not merely another means to form white light but a new means to form light of different colors. Most perceivable colors can be formed by mixing different amounts of three primary colors. This allows precise dynamic color control. As more effort is devoted to investigating this method, multi-color LEDs should have profound influence on the fundamental method that we use to produce and control light color. However, before this type of LED can play a role on the market, several technical problems must be solved. These include that this type of LED's emission power decays exponentially with rising temperature,^[92] resulting in a substantial change in color stability. Such problems inhibit and may preclude industrial use. Thus, many new package designs aimed at solving this problem have been proposed and their results are now being reproduced by researchers and scientists.

Correlated color temperature (CCT) dimming for LED technology is regarded as a difficult task, since binning, age and temperature drift effects of LEDs change the actual color value output. Feedback loop systems are used for example with color sensors, to actively monitor and control the color output of multiple color mixing LEDs.^[93]

Phosphor-based LEDs

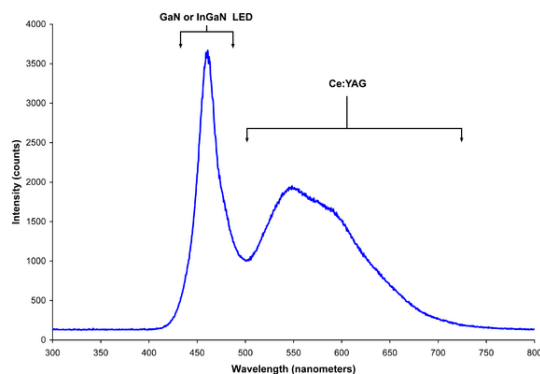

Spectrum of a white LED showing blue light directly emitted by the GaN-based LED (peak at about 465 nm) and the more broadband Stokes-shifted light emitted by the Ce³⁺:YAG phosphor, which emits at roughly 500–700 nm

This method involves coating LEDs of one color (mostly blue LEDs made of InGaN) with phosphors of different colors to form white light; the resultant LEDs are called phosphor-based or phosphor-converted white LEDs (pcLEDs).^[94] A fraction of the blue light undergoes the Stokes shift being transformed from shorter wavelengths to longer. Depending on the color of the original LED, phosphors of different colors can be employed. If several phosphor layers of distinct colors are applied, the emitted spectrum is broadened, effectively raising the color rendering index (CRI) value of a given LED.^[95]

Phosphor-based LED efficiency losses are due to the heat loss from the Stokes shift and also other phosphor-related degradation issues. Their luminous efficacies compared to normal LEDs depend on the spectral distribution of the resultant light output and the original wavelength of the LED itself. For example, the luminous efficacy of a typical YAG yellow phosphor based white LED ranges from 3 to 5 times the luminous efficacy of the original blue LED because of the human eye's greater sensitivity to yellow than to blue (as modeled in the luminosity function). Due to the simplicity of manufacturing the phosphor method is still the most popular method for making high-intensity white LEDs. The design and production of a light source or light fixture using a monochrome emitter with phosphor conversion is simpler and cheaper than a complex RGB system, and the majority of high-intensity

white LEDs presently on the market are manufactured using phosphor light conversion.

Among the challenges being faced to improve the efficiency of LED-based white light sources is the development of more efficient phosphors. As of 2010, the most efficient yellow phosphor is still the YAG phosphor, with less than 10% Stoke shift loss. Losses attributable to internal optical losses due to re-absorption in the LED chip and in the LED packaging itself account typically for another 10% to 30% of efficiency loss. Currently, in the area of phosphor LED development, much effort is being spent on optimizing these devices to higher light output and higher operation temperatures. For instance, the efficiency can be raised by adapting better package design or by using a more suitable type of phosphor. Conformal coating process is frequently used to address the issue of varying phosphor thickness.

Some phosphor-based white LEDs encapsulate InGaN blue LEDs inside phosphor-coated epoxy. Alternatively, the LED might be paired with a remote phosphor, a preformed polycarbonate piece coated with the phosphor material. Remote phosphors provide more diffuse light, which is desirable for many applications. Remote phosphor designs are also more tolerant of variations in the LED emissions spectrum. A common yellow phosphor material is cerium-doped yttrium aluminium garnet (Ce^{3+} :YAG).

White LEDs can also be made by coating near-ultraviolet (NUV) LEDs with a mixture of high-efficiency europium-based phosphors that emit red and blue, plus copper and aluminium-doped zinc sulfide ($\text{ZnS}:\text{Cu}, \text{Al}$) that emits green. This is a method analogous to the way fluorescent lamps work. This method is less efficient than blue LEDs with YAG:Ce phosphor, as the Stokes shift is larger, so more energy is converted to heat, but yields light with better spectral characteristics, which render color better. Due to the higher radiative output of the ultraviolet LEDs than of the blue ones, both methods offer comparable brightness. A concern is that UV light may leak from a malfunctioning light source and cause harm to human eyes or skin.

Other white LEDs

Another method used to produce experimental white light LEDs used no phosphors at all and was based on homoepitaxially grown zinc selenide (ZnSe) on a ZnSe substrate that simultaneously emitted blue light from its active region and yellow light from the substrate.^[96]

A new style of wafers composed of gallium-nitride-on-silicon (GaN-on-Si) is being used to produce white LEDs using 200-mm silicon wafers. This avoids the typical costly sapphire substrates in relatively small 100- or 150-mm wafer sizes.^[97] It is predicted that by 2020, 40% of all GaN LEDs will be made with GaN-on-Si . Manufacturing large sapphire material is difficult, while large silicon

material is cheaper and more abundant. LED companies shifting from using sapphire to silicon should be a minimal investment.^[98]

6.4.4 Organic light-emitting diodes (OLEDs)

Main article: [Organic light-emitting diode](#)

In an organic light-emitting diode (OLED), the

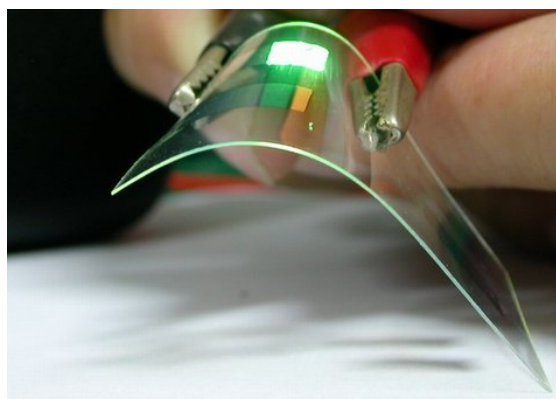

Demonstration of a flexible OLED device

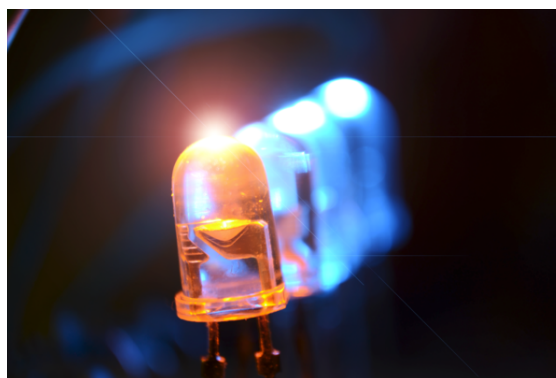

Orange light-emitting diode

electroluminescent material comprising the emissive layer of the diode is an organic compound. The organic material is electrically conductive due to the delocalization of pi electrons caused by conjugation over all or part of the molecule, and the material therefore functions as an organic semiconductor.^[99] The organic materials can be small organic molecules in a crystalline phase, or polymers.

The potential advantages of OLEDs include thin, low-cost displays with a low driving voltage, wide viewing angle, and high contrast and color gamut.^[100] Polymer LEDs have the added benefit of printable^{[101][102]} and flexible^[103] displays. OLEDs have been used to make visual displays for portable electronic devices such as cell-phones, digital cameras, and MP3 players while possible future uses include lighting and televisions.^[100]

6.4.5 Quantum dot LEDs

Quantum dots (QD) are semiconductor nanocrystals that possess unique optical properties.^[104] Their emission color can be tuned from the visible throughout the infrared spectrum. This allows quantum dot LEDs to create almost any color on the CIE diagram. This provides more color options and better color rendering than white LEDs since the emission spectra is much narrower, characteristic of quantum confined states. There are two types of schemes for QD excitation. One uses photo excitation with a primary light source LED (typically blue or UV LEDs are used). The other is direct electrical excitation first demonstrated by Alivisatos et al.^[105]

One example of the photo-excitation scheme is a method developed by Michael Bowers, at Vanderbilt University in Nashville, involving coating a blue LED with quantum dots that glow white in response to the blue light from the LED. This method emits a warm, yellowish-white light similar to that made by incandescent bulbs.^[106] Quantum dots are also being considered for use in white light-emitting diodes in liquid crystal display (LCD) televisions.^[107]

In February 2011 scientists at PlasmaChem GmbH could synthesize quantum dots for LED applications and build a light converter on their basis, which could efficiently convert light from blue to any other color for many hundred hours.^[108] Such QDs can be used to emit visible or near infrared light of any wavelength being excited by light with a shorter wavelength.

The structure of QD-LEDs used for the electrical-excitation scheme is similar to basic design of OLED. A layer of quantum dots is sandwiched between layers of electron-transporting and hole-transporting materials. An applied electric field causes electrons and holes to move into the quantum dot layer and recombine forming an exciton that excites a QD. This scheme is commonly studied for quantum dot display. The tunability of emission wavelengths and narrow bandwidth is also beneficial as excitation sources for fluorescence imaging. Fluorescence near-field scanning optical microscopy (NSOM) utilizing an integrated QD-LED has been demonstrated.^[109]

In February 2008, a luminous efficacy of 300 lumens of visible light per watt of radiation (not per electrical watt) and warm-light emission was achieved by using nanocrystals.^[110]

6.5 Types

The main types of LEDs are miniature, high-power devices and custom designs such as alphanumeric or multi-color.^[111]

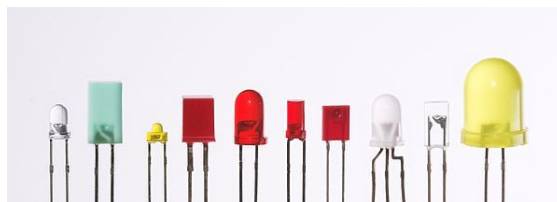

LEDs are produced in a variety of shapes and sizes. The color of the plastic lens is often the same as the actual color of light emitted, but not always. For instance, purple plastic is often used for infrared LEDs, and most blue devices have colorless housings. Modern high-power LEDs such as those used for lighting and backlighting are generally found in surface-mount technology (SMT) packages (not shown).

6.5.1 Miniature



Photo of miniature surface mount LEDs in most common sizes. They can be much smaller than a traditional 5 mm lamp type LED which is shown on the upper left corner.

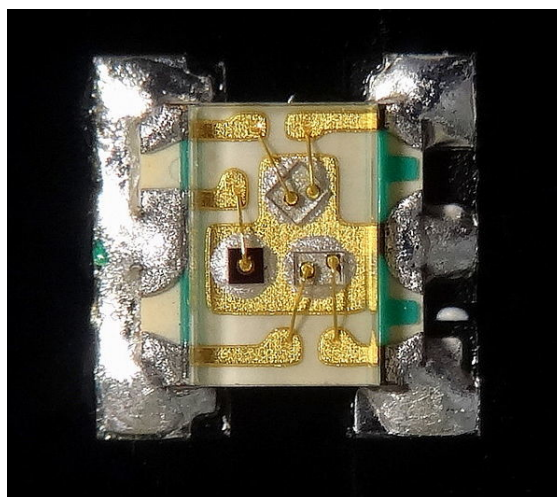

Very small (1.6x1.6x0.35 mm) red, green, and blue surface mount miniature LED package with gold wire bonding details.

These are mostly single-die LEDs used as indicators, and they come in various sizes from 2 mm to 8 mm, through-hole and surface mount packages. They usually do not use a separate heat sink.^[112] Typical current ratings ranges

from around 1 mA to above 20 mA. The small size sets a natural upper boundary on power consumption due to heat caused by the high current density and need for a heat sink.

Common package shapes include round, with a domed or flat top, rectangular with a flat top (as used in bar-graph displays), and triangular or square with a flat top. The encapsulation may also be clear or tinted to improve contrast and viewing angle.

Researchers at the University of Washington have invented the thinnest LED. It is made of two-dimensional (2-D) flexible materials. It is 3 atoms thick, which is 10 to 20 times thinner than three-dimensional (3-D) LEDs and is also 10,000 times smaller than the thickness of a human hair. These 2-D LEDs are going to make it possible to create smaller, more energy-efficient lighting, optical communication and nano lasers.^[113]

There are three main categories of miniature single die LEDs:

- Low-current: typically rated for 2 mA at around 2 V (approximately 4 mW consumption).
- Standard: 20 mA LEDs (ranging from approximately 40 mW to 90 mW) at around:
 - 1.9 to 2.1 V for red, orange and yellow,
 - 3.0 to 3.4 V for green and blue,
 - 2.9 to 4.2 V for violet, pink, purple and white.
- Ultra-high-output: 20 mA at approximately 2 V or 4–5 V, designed for viewing in direct sunlight.

5 V and 12 V LEDs are ordinary miniature LEDs that incorporate a suitable series resistor for direct connection to a 5 V or 12 V supply.

6.5.2 Mid-range

Medium-power LEDs are often through-hole-mounted and mostly utilized when an output of just tens of lumens are needed. They sometimes have the diode mounted to four leads (two cathode leads, two anode leads) for better heat conduction and carry an integrated lens. An example of this is the Superflux package, from Philips Lumileds. These LEDs are most commonly used in light panels, emergency lighting, and automotive tail-lights. Due to the larger amount of metal in the LED, they are able to handle higher currents (around 100 mA). The higher current allows for the higher light output required for tail-lights and emergency lighting.

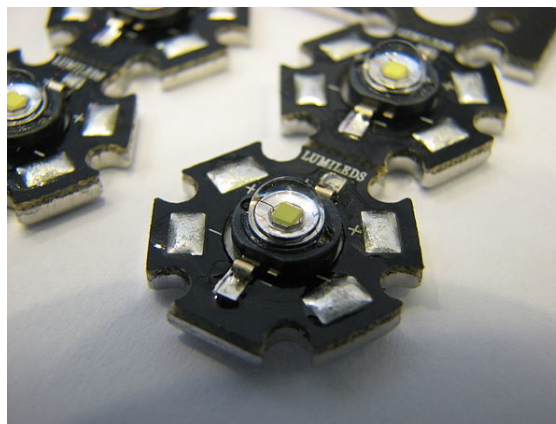

High-power light-emitting diodes attached to an LED star base (Luxeon, Lumileds)

6.5.3 High-power

See also: Solid-state lighting, LED lamp and Thermal management of high-power LEDs

High-power LEDs (HPLEDs) or high-output LEDs (HOLEDs) can be driven at currents from hundreds of mA to more than an ampere, compared with the tens of mA for other LEDs. Some can emit over a thousand lumens.^{[114][115]} LED power densities up to 300 W/cm² have been achieved.^[116] Since overheating is destructive, the HPLEDs must be mounted on a heat sink to allow for heat dissipation. If the heat from a HPLED is not removed, the device will fail in seconds. One HPLED can often replace an incandescent bulb in a flashlight, or be set in an array to form a powerful LED lamp.

Some well-known HPLEDs in this category are the Nichia 19 series, Lumileds Rebel Led, Osram Opto Semiconductors Golden Dragon, and Cree X-lamp. As of September 2009, some HPLEDs manufactured by Cree Inc. now exceed 105 lm/W^[117] (e.g. the XLamp XP-G LED chip emitting Cool White light) and are being sold in lamps intended to replace incandescent, halogen, and even fluorescent lights, as LEDs grow more cost competitive.

The impact of Haitz's law which describes the exponential rise in light output of LEDs over time can be readily seen in year over year increases in lumen output and efficiency. For example, the CREE XP-G series LED achieved 105 lm/W in 2009,^[117] while Nichia released the 19 series with a typical efficacy of 140 lm/W in 2010.^[118]

6.5.4 AC driven LED

LEDs have been developed by Seoul Semiconductor that can operate on AC power without the need for a DC converter. For each half-cycle, part of the LED emits light and part is dark, and this is reversed during the next half-

cycle. The efficacy of this type of HPLED is typically 40 lm/W.^[119] A large number of LED elements in series may be able to operate directly from line voltage. In 2009, Seoul Semiconductor released a high DC voltage LED, named as 'Acrich MJT', capable of being driven from AC power with a simple controlling circuit. The low-power dissipation of these LEDs affords them more flexibility than the original AC LED design.^[120]

6.5.5 Application-specific variations

Flashing

Used as attention seeking indicators without requiring external electronics. Flashing LEDs resemble standard LEDs but they contain an integrated multivibrator circuit that causes the LED to flash with a typical period of one second. In diffused lens LEDs this is visible as a small black dot. Most flashing LEDs emit light of one color, but more sophisticated devices can flash between multiple colors and even fade through a color sequence using RGB color mixing.

Bi-color LED

Two different LED emitters in one case. There are two types of these. One type consists of two dies connected to the same two leads antiparallel to each other. Current flow in one direction emits one color, and current in the opposite direction emits the other color. The other type consists of two dies with separate leads for both dies and another lead for common anode or cathode, so that they can be controlled independently.



A decorative garden light that changes color

Tri-color

Three different LED emitters in one case. Each emitter is connected to a separate lead so they can be controlled independently. A four-lead arrangement is typical with one common lead (anode or cathode) and an additional lead for each color.

RGB

Tri-color LEDs with red, green, and blue emitters, in general using a four-wire connection with one common lead (anode or cathode). These LEDs can have either common positive or common negative leads. Others however, have only two leads (positive and negative) and have a built in tiny electronic control unit.

Decorative multicolor

Incorporates several emitters of different colors supplied by only two lead-out wires. Colors are switched internally simply by varying the supply voltage. (In a cheap 'Melinera' garden lamp supplied by OWIM GmbH & Co KG in 2013 the LEDs are within a clear casting of 5mm diameter, 10mm long which encapsulates 3 LEDs which change between red, green and blue as the DC supply varies between about 2 volts and 3 volts).

Alphanumeric

Available in seven-segment, starburst and dot-matrix format. Seven-segment displays handle all numbers and a limited set of letters. Starburst displays can display all letters. Dot-matrix displays typically use 5x7 pixels per character. Seven-segment LED displays were in widespread use in the 1970s and 1980s, but rising use of liquid crystal displays, with their lower power needs and greater display flexibility, has reduced the popularity of numeric and alphanumeric LED displays.

Digital RGB

These are RGB LEDs that contain their own "smart" control electronics. In addition to power and ground, these provide connections for data in, data out, and sometimes a clock or strobe signal. These are connected in a daisy chain, with the data in of the first LED sourced by a microprocessor, which can control the brightness and color of each LED independently of the others. They are used where a combination of maximum control and minimum visible electronics are needed such as strings for Christmas and LED matrices, few even have refresh rates in the kHz range allowing for basic video applications.

6.6 Considerations for use

6.6.1 Power sources

Main article: [LED power sources](#)

The current–voltage characteristic of an LED is similar to other diodes, in that the current is dependent expo-

nentially on the voltage (see **Shockley diode equation**). This means that a small change in voltage can cause a large change in current. If the applied voltage exceeds the LED's forward voltage drop by a small amount, the current rating may be exceeded by a large amount, potentially damaging or destroying the LED. The typical solution is to use **constant-current** power supplies to keep the current below the LED's maximum current rating. Since most common power sources (batteries, mains) are constant-voltage sources, most LED fixtures must include a power converter, at least a current-limiting resistor. However, the high resistance of 3 V coin cells combined with the high differential resistance of nitride-based LEDs makes it possible to power such an LED from such a coin cell without an external resistor.^[121]

6.6.2 Electrical polarity

Main article: [Electrical polarity of LEDs](#)

As with all diodes, current flows easily from p-type to n-type material.^[122] However, no current flows and no light is emitted if a small voltage is applied in the reverse direction. If the reverse voltage grows large enough to exceed the **breakdown voltage**, a large current flows and the LED may be damaged. If the reverse current is sufficiently limited to avoid damage, the reverse-conducting LED is a useful **noise diode**.

6.6.3 Safety and health

The vast majority of devices containing LEDs are “safe under all conditions of normal use”, and so are classified as “Class 1 LED product”/“LED Klasse 1”. At present, only a few LEDs—extremely bright LEDs that also have a tightly focused viewing angle of 8° or less—could, in theory, cause temporary blindness, and so are classified as “Class 2”.^[123] The opinion of the French Agency for Food, Environmental and Occupational Health & Safety (ANSES) of 2010, on the health issues concerning LEDs, suggested banning public use of lamps which were in the moderate Risk Group 2, especially those with a high blue component in places frequented by children.^[124] In general, **laser safety** regulations—and the “Class 1”, “Class 2”, etc. system—also apply to LEDs.^[125]

While LEDs have the advantage over **fluorescent lamps** that they do not contain **mercury**, they may contain other hazardous metals such as **lead** and **arsenic**. A study published in 2011 states (concerning toxicity of LEDs when treated as waste): “According to federal standards, LEDs are not hazardous except for low-intensity red LEDs, which leached Pb [lead] at levels exceeding regulatory limits (186 mg/L; regulatory limit: 5). However, according to California regulations, excessive levels of copper (up to 3892 mg/kg; limit: 2500), lead (up to 8103 mg/kg; limit: 1000), nickel (up to 4797 mg/kg; limit: 2000), or

silver (up to 721 mg/kg; limit: 500) render all except low-intensity yellow LEDs hazardous.”^[126]

6.6.4 Advantages

- **Efficiency:** LEDs emit more lumens per watt than **incandescent light bulbs**.^[127] The efficiency of LED lighting fixtures is not affected by shape and size, unlike **fluorescent light bulbs** or tubes.
- **Color:** LEDs can emit light of an intended color without using any color filters as traditional lighting methods need. This is more efficient and can lower initial costs.
- **Size:** LEDs can be very small (smaller than 2 mm²^[128]) and are easily attached to printed circuit boards.
- **On/Off time:** LEDs light up very quickly. A typical red indicator LED will achieve full brightness in under a **microsecond**.^[129] LEDs used in communications devices can have even faster response times.
- **Cycling:** LEDs are ideal for uses subject to frequent on-off cycling, unlike incandescent and fluorescent lamps that fail faster when cycled often, or **High-intensity discharge lamps** (HID lamps) that require a long time before restarting.
- **Dimming:** LEDs can very easily be dimmed either by **pulse-width modulation** or lowering the forward current.^[130] This pulse-width modulation is why LED lights, particularly headlights on cars, when viewed on camera or by some people, appear to be flashing or flickering. This is a type of **stroboscopic effect**.
- **Cool light:** In contrast to most light sources, LEDs radiate very little heat in the form of IR that can cause damage to sensitive objects or fabrics. Wasted energy is dispersed as heat through the base of the LED.
- **Slow failure:** LEDs mostly fail by dimming over time, rather than the abrupt failure of incandescent bulbs.^[61]
- **Lifetime:** LEDs can have a relatively long useful life. One report estimates 35,000 to 50,000 hours of useful life, though time to complete failure may be longer.^[131] Fluorescent tubes typically are rated at about 10,000 to 15,000 hours, depending partly on the conditions of use, and incandescent light bulbs at 1,000 to 2,000 hours. Several DOE demonstrations have shown that reduced maintenance costs from this extended lifetime, rather than energy savings, is the primary factor in determining the payback period for an LED product.^[132]

- **Shock resistance:** LEDs, being solid-state components, are difficult to damage with external shock, unlike fluorescent and incandescent bulbs, which are fragile.
- **Focus:** The solid package of the LED can be designed to focus its light. Incandescent and fluorescent sources often require an external reflector to collect light and direct it in a usable manner. For larger LED packages total internal reflection (TIR) lenses are often used to the same effect. However, when large quantities of light are needed many light sources are usually deployed, which are difficult to focus or collimate towards the same target.

6.6.5 Disadvantages

- **High initial price:** LEDs are currently more expensive, price per lumen, on an initial capital cost basis, than most conventional lighting technologies. As of 2012, the cost per thousand lumens (kilolumen) was about \$6. The price was expected to reach \$2/kilolumen by 2013.^[133] At least one manufacturer claims to have reached \$1 per kilolumen as of March 2014.^[134] The additional expense partially stems from the relatively low lumen output and the drive circuitry and power supplies needed.
- **Temperature dependence:** LED performance largely depends on the ambient temperature of the operating environment – or “thermal management” properties. Over-driving an LED in high ambient temperatures may result in overheating the LED package, eventually leading to device failure. An adequate heat sink is needed to maintain long life. This is especially important in automotive, medical, and military uses where devices must operate over a wide range of temperatures, which require low failure rates. Toshiba has produced LEDs with an operating temperature range of -40 to 100 °C, which suits the LEDs for both indoor and outdoor use in applications such as lamps, ceiling lighting, street lights, and floodlights.^[97]
- **Voltage sensitivity:** LEDs must be supplied with the voltage above the threshold and a current below the rating. Current and lifetime change greatly with small change in applied voltage. They thus require a current-regulated supply (usually just a series resistor for indicator LEDs).^[135]
- **Light quality:** Most cool-white LEDs have spectra that differ significantly from a black body radiator like the sun or an incandescent light. The spike at 460 nm and dip at 500 nm can cause the color of objects to be perceived differently under cool-white LED illumination than sunlight or incandescent sources, due to metamerism,^[136] red surfaces being rendered particularly badly by typical phosphor-based cool-white LEDs. However, the color-rendering properties of common fluorescent lamps are often inferior to what is now available in state-of-art white LEDs.
- **Area light source:** Single LEDs do not approximate a point source of light giving a spherical light distribution, but rather a lambertian distribution. So LEDs are difficult to apply to uses needing a spherical light field; however, different fields of light can be manipulated by the application of different optics or “lenses”. LEDs cannot provide divergence below a few degrees. In contrast, lasers can emit beams with divergences of 0.2 degrees or less.^[137]
- **Electrical polarity:** Unlike incandescent light bulbs, which illuminate regardless of the electrical polarity, LEDs will only light with correct electrical polarity. To automatically match source polarity to LED devices, rectifiers can be used.
- **Blue hazard:** There is a concern that blue LEDs and cool-white LEDs are now capable of exceeding safe limits of the so-called blue-light hazard as defined in eye safety specifications such as ANSI/IESNA RP-27.1–05: Recommended Practice for Photobiological Safety for Lamp and Lamp Systems.^{[138][139]}
- **Blue pollution:** Because cool-white LEDs with high color temperature emit proportionally more blue light than conventional outdoor light sources such as high-pressure sodium vapor lamps, the strong wavelength dependence of Rayleigh scattering means that cool-white LEDs can cause more light pollution than other light sources. The International Dark-Sky Association discourages using white light sources with correlated color temperature above 3,000 K.^[120]
- **Efficiency droop:** The luminous efficacy of LEDs decreases as the electrical current increases. Heating also increases with higher currents which compromises the lifetime of the LED. These effects put practical limits on the current through an LED in high power applications.^{[54][56][57][140]}
- **Impact on insects:** LEDs are much more attractive to insects than sodium-vapor lights, so much so that there has been speculative concern about the possibility of disruption to food webs.^{[141][142]}
- **Use In Winter Conditions:** Since they do not give off much heat in comparison to traditional electrical lights, LED lights used for traffic control can have snow obscuring them, leading to accidents.^{[143][144]}

6.7 Applications

LED uses fall into four major categories:

- Visual signals where light goes more or less directly from the source to the human eye, to convey a message or meaning.
- Illumination where light is reflected from objects to give visual response of these objects.
- Measuring and interacting with processes involving no human vision.^[145]
- Narrow band light sensors where LEDs operate in a reverse-bias mode and respond to incident light, instead of emitting light.^{[146][147][148][149]} See LEDs as light sensors.



Automotive applications for LEDs continue to grow

6.7.1 Indicators and signs

The low energy consumption, low maintenance and small size of LEDs has led to uses as status indicators and displays on a variety of equipment and installations. Large-area LED displays are used as stadium displays and as dynamic decorative displays. Thin, lightweight message displays are used at airports and railway stations, and as destination displays for trains, buses, trams, and ferries.



Red and green traffic signals

One-color light is well suited for traffic lights and signals, exit signs, emergency vehicle lighting, ships' navigation lights or lanterns (chromacity and luminance standards being set under the Convention on the International Regulations for Preventing Collisions at Sea 1972, Annex I and the CIE) and LED-based Christmas lights. In cold climates, LED traffic lights may remain snow-covered.^[150] Red or yellow LEDs are used in indicator and alphanumeric displays in environments where night vision must be retained: aircraft cockpits, submarine and ship bridges, astronomy observatories, and in the field, e.g. night time animal watching and military field use.

Because of their long life, fast switching times, and their ability to be seen in broad daylight due to their high output and focus, LEDs have been used in brake lights for cars' high-mounted brake lights, trucks, and buses, and in turn signals for some time, but many vehicles now use LEDs for their rear light clusters. The use in brakes improves safety, due to a great reduction in the time needed to light fully, or faster rise time, up to 0.5 second faster than an incandescent bulb. This gives drivers behind more time to react. It is reported that at normal highway speeds, this equals one car length equivalent in increased time to react. In a dual intensity circuit (rear markers and brakes) if the LEDs are not pulsed at a fast enough frequency, they can create a phantom array, where ghost images of the LED will appear if the eyes quickly scan across the array. White LED headlamps are starting to be used. Using LEDs has styling advantages because LEDs can form much thinner lights than incandescent lamps with parabolic reflectors.

Due to the relative cheapness of low output LEDs, they are also used in many temporary uses such as glowsticks, throwies, and the photonic textile Lumalive. Artists have also used LEDs for LED art.

Weather and all-hazards radio receivers with Specific Area Message Encoding (SAME) have three LEDs: red for warnings, orange for watches, and yellow for advisories and statements whenever issued.

6.7.2 Lighting

See also: LED lamp and LED-backlit LCD

With the development of high-efficiency and high-power LEDs, it has become possible to use LEDs in lighting and illumination. Replacement light bulbs have been made, as well as dedicated fixtures and LED lamps. To encourage the shift to very high efficiency lighting, the US Department of Energy has created the L Prize competition. The Philips Lighting North America LED bulb won the first competition on August 3, 2011 after successfully

completing 18 months of intensive field, lab, and product testing.^[151]

LEDs are used as street lights and in other architectural lighting where color changing is used. The mechanical robustness and long lifetime is used in automotive lighting on cars, motorcycles, and bicycle lights.

LED street lights are employed on poles and in parking garages. In 2007, the Italian village Torraca was the first place to convert its entire illumination system to LEDs.^[152]

LEDs are used in aviation lighting. Airbus has used LED lighting in their Airbus A320 Enhanced since 2007, and Boeing uses LED lighting in the 787. LEDs are also being used now in airport and heliport lighting. LED airport fixtures currently include medium-intensity runway lights, runway centerline lights, taxiway centerline and edge lights, guidance signs, and obstruction lighting.

LEDs are also suitable for backlighting for LCD televisions and lightweight laptop displays and light source for DLP projectors (See LED TV). RGB LEDs raise the color gamut by as much as 45%. Screens for TV and computer displays can be made thinner using LEDs for backlighting.^[153]

LEDs are used increasingly in aquarium lights. In particular for reef aquariums, LED lights provide an efficient light source with less heat output to help maintain optimal aquarium temperatures. LED-based aquarium fixtures also have the advantage of being manually adjustable to emit a specific color-spectrum for ideal coloration of corals, fish, and invertebrates while optimizing photosynthetically active radiation (PAR), which raises growth and sustainability of photosynthetic life such as corals, anemones, clams, and macroalgae. These fixtures can be electronically programmed to simulate various lighting conditions throughout the day, reflecting phases of the sun and moon for a dynamic reef experience. LED fixtures typically cost up to five times as much as similarly rated fluorescent or high-intensity discharge lighting designed for reef aquariums and are not as high output to date.

The lack of IR or heat radiation makes LEDs ideal for stage lights using banks of RGB LEDs that can easily change color and decrease heating from traditional stage lighting, as well as medical lighting where IR-radiation can be harmful. In energy conservation, the lower heat output of LEDs also means air conditioning (cooling) systems have less heat to dispose of.

LEDs are small, durable and need little power, so they are used in hand held devices such as flashlights. LED strobe lights or camera flashes operate at a safe, low voltage, instead of the 250+ volts commonly found in xenon flashlamp-based lighting. This is especially useful in cameras on mobile phones, where space is at a premium and bulky voltage-raising circuitry is undesirable.

LEDs are used for infrared illumination in night vision



LED to be used for miners, to increase visibility inside mines.

uses including security cameras. A ring of LEDs around a video camera, aimed forward into a retroreflective background, allows chroma keying in video productions.

LEDs are used in mining operations, as cap lamps to provide light for miners. Research has been done to improve LEDs for mining, to reduce glare and to increase illumination, reducing risk of injury for the miners.^[154]

LEDs are now used commonly in all market areas from commercial to home use: standard lighting, AV, stage, theatrical, architectural, and public installations, and wherever artificial light is used.

LEDs are increasingly finding uses in medical and educational applications, for example as mood enhancement, and new technologies such as AmBX, exploiting LED versatility. NASA has even sponsored research for the use of LEDs to promote health for astronauts.^[155]

6.7.3 Data communication and other signaling

See also: Li-Fi

Light can be used to transmit data and analog signals.

Assistive listening devices in many theaters and similar spaces use arrays of infrared LEDs to send sound to listeners' receivers. Light-emitting diodes (as well as semiconductor lasers) are used to send data over many types of fiber optic cable, from digital audio over TOSLINK cables to the very high bandwidth fiber links that form the internet backbone. For some time, computers were commonly equipped with IrDA interfaces, which allowed them to send and receive data to nearby machines via infrared.

Because LEDs can cycle on and off millions of times per second, very high data bandwidth can be achieved.^[156]

6.7.4 Sustainable lighting

Efficient lighting is needed for sustainable architecture. In 2009, a typical 13-watt LED lamp emitted 450 to 650 lumens,^[157] which is equivalent to a standard 40-watt incandescent bulb. In 2011, LEDs had become more efficient, so that a 6-watt LED could easily achieve the same results. A standard 40-watt incandescent bulb has an expected lifespan of 1,000 hours, whereas an LED can continue to operate with reduced efficiency for more than 50,000 hours, 50 times longer than the incandescent bulb.

Energy consumption

In the US, one kilowatt-hour (3.6 MJ) of electricity currently causes an average 1.34 pounds (610 g) of CO₂ emission.^[158] Assuming the average light bulb is on for 10 hours a day, a 40-watt bulb will cause 196 pounds (89 kg) of CO₂

emission per year. The 6-watt LED equivalent will only cause 30 pounds (14 kg) of CO₂

emission over the same time span. A building's carbon footprint from lighting can therefore be reduced by 85% by exchanging all incandescent bulbs for new LEDs if a building previously used only incandescent bulbs.

In practice, most buildings that use a lot of lighting use fluorescent lighting, which has 22% luminous efficiency compared with 5% for filaments, so changing to LED lighting would still give a 34% reduction in electrical power use and carbon emissions.

The reduction in carbon emissions depends on the source of electricity. Nuclear power in the United States produced 19.2% of electricity in 2011, so reducing electricity consumption in the U.S. reduces carbon emissions more than in France (75% nuclear electricity) or Norway (almost entirely hydroelectric).

Replacing lights that spend the most time lit results in the most savings, so LED lights in infrequently used locations bring a smaller return on investment.

Economically sustainable

LED light bulbs could be a cost-effective option for lighting a home or office space because of their very long lifetimes. Consumer use of LEDs as a replacement for conventional lighting system is currently hampered by the high cost and low efficiency of available products. 2009 DOE testing results showed an average efficacy of 35 lm/W, below that of typical CFLs, and as low as 9 lm/W, worse than standard incandescents.^[157] However, as of 2011, there are LED bulbs available as efficient as 150 lm/W and even inexpensive low-end models typically exceed 50 lm/W. The high initial cost of commercial LED bulbs is due to the expensive sapphire substrate, which is key to the production process. The sapphire apparatus must be coupled with a mirror-like collector to reflect

light that would otherwise be wasted.

6.7.5 Light sources for machine vision systems

Machine vision systems often require bright and homogeneous illumination, so features of interest are easier to process. LEDs are often used for this purpose, and this is likely to remain one of their major uses until price drops low enough to make signaling and illumination uses more widespread. Barcode scanners are the most common example of machine vision, and many low cost ones use red LEDs instead of lasers. Optical computer mice are also another example of LEDs in machine vision, as it is used to provide an even light source on the surface for the miniature camera within the mouse. LEDs constitute a nearly ideal light source for machine vision systems for several reasons:

- The size of the illuminated field is usually comparatively small and machine vision systems are often quite expensive, so the cost of the light source is usually a minor concern. However, it might not be easy to replace a broken light source placed within complex machinery, and here the long service life of LEDs is a benefit.
- LED elements tend to be small and can be placed with high density over flat or even-shaped substrates (PCBs etc.) so that bright and homogeneous sources that direct light from tightly controlled directions on inspected parts can be designed. This can often be obtained with small, low-cost lenses and diffusers, helping to achieve high light densities with control over lighting levels and homogeneity. LED sources can be shaped in several configurations (spot lights for reflective illumination; ring lights for coaxial illumination; back lights for contour illumination; linear assemblies; flat, large format panels; dome sources for diffused, omnidirectional illumination).
- LEDs can be easily strobed (in the microsecond range and below) and synchronized with imaging. High-power LEDs are available allowing well-lit images even with very short light pulses. This is often used to obtain crisp and sharp "still" images of quickly moving parts.
- LEDs come in several different colors and wavelengths, allowing easy use of the best color for each need, where different color may provide better visibility of features of interest. Having a precisely known spectrum allows tightly matched filters to be used to separate informative bandwidth or to reduce disturbing effects of ambient light. LEDs usually operate at comparatively low working temperatures, simplifying heat management and dissipation. This allows using plastic lenses, filters, and

diffusers. Waterproof units can also easily be designed, allowing use in harsh or wet environments (food, beverage, oil industries).

- A large LED display behind a disc jockey
- LED destination signs on buses, one with a colored route number
- LED digital display that can display four digits and points
- Traffic light using LED
- LED daytime running lights of Audi A4
- LED panel light source used in an experiment on plant growth. The findings of such experiments may be used to grow food in space on long duration missions.
- LED lights reacting dynamically to video feed via AmBX
- Different sized LEDs. 8 mm, 5 mm and 3 mm, with a wooden match-stick for scale.
- A green surface-mount colored LED mounted on an Arduino circuit board

6.7.6 Other applications

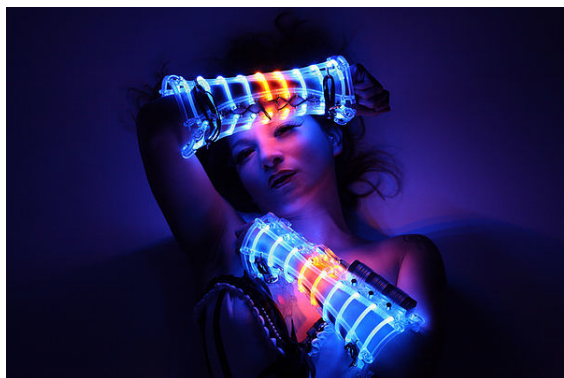

LED costume for stage performers.

The light from LEDs can be modulated very quickly so they are used extensively in optical fiber and free space optics communications. This includes remote controls, such as for TVs, VCRs, and LED Computers, where infrared LEDs are often used. Opto-isolators use an LED combined with a photodiode or phototransistor to provide a signal path with electrical isolation between two circuits. This is especially useful in medical equipment where the signals from a low-voltage sensor circuit (usually battery-powered) in contact with a living organism must be electrically isolated from any possible electrical failure in a recording or monitoring device operating at

potentially dangerous voltages. An optoisolator also allows information to be transferred between circuits not sharing a common ground potential.

Many sensor systems rely on light as the signal source. LEDs are often ideal as a light source due to the requirements of the sensors. LEDs are used as motion sensors, for example in optical computer mice. The Nintendo Wii's sensor bar uses infrared LEDs. Pulse oximeters use them for measuring oxygen saturation. Some flatbed scanners use arrays of RGB LEDs rather than the typical cold-cathode fluorescent lamp as the light source. Having independent control of three illuminated colors allows the scanner to calibrate itself for more accurate color balance, and there is no need for warm-up. Further, its sensors only need be monochromatic, since at any one time the page being scanned is only lit by one color of light. Touch sensing: Since LEDs can also be used as photodiodes, they can be used for both photo emission and detection. This could be used, for example, in a touch-sensing screen that registers reflected light from a finger or stylus.^[159] Many materials and biological systems are sensitive to or dependent on light. Grow lights use LEDs to increase photosynthesis in plants^[160] and bacteria and viruses can be removed from water and other substances using UV LEDs for sterilization.^[88] Plant growers are interested in LEDs because they are more energy-efficient, emit less heat (can damage plants close to hot lamps), and can provide the optimum light frequency for plant growth and bloom periods compared to currently used grow lights: HPS (high-pressure sodium), metal-halide (MH) or CFL/low-energy. However, LEDs have not replaced these grow lights due to higher price. As mass production and LED kits develop, the LED products will become cheaper. LEDs have also been used as a medium-quality voltage reference in electronic circuits. The forward voltage drop (e.g., about 1.7 V for a normal red LED) can be used instead of a Zener diode in low-voltage regulators. Red LEDs have the flattest I/V curve above the knee. Nitride-based LEDs have a fairly steep I/V curve and are useless for this purpose. Although LED forward voltage is far more current-dependent than a good Zener, Zener diodes are not widely available below voltages of about 3 V.

6.8 See also

- Display examples
- Laser diode
- Light-emitting electrochemical cell (LEC)
- LED circuit
- LED lamp
- LED tattoo
- LED as light sensor

- Li-Fi
- List of LED failure modes
- Luminous efficacy
- Nixie tube
- OLED
- Photovoltaics
- Seven-segment display
- SMD LED Module
- Solar lamp
- Solid-state lighting
- Thermal management of high-power LEDs
- UV LED curing

6.9 References

- [1] “The life and times of the LED — a 100-year history” (PDF). The Optoelectronics Research Centre, University of Southampton. April 2007. Retrieved September 4, 2012.
- [2] US Patent 3293513, “Semiconductor Radiant Diode”, James R. Biard and Gary Pittman, Filed on Aug. 8th, 1962, Issued on Dec. 20th, 1966.
- [3] “Inventor of Long-Lasting, Low-Heat Light Source Awarded \$500,000 Lemelson-MIT Prize for Invention”. Washington, D.C. Massachusetts Institute of Technology. April 21, 2004. Retrieved December 21, 2011.
- [4] “LED”. *The American heritage science dictionary*. Houghton Mifflin Company. 2005. led and LED.
- [5] Moreno, I.; Sun, C. C. (2008). “Modeling the radiation pattern of LEDs”. *Optics express* **16** (3): 1808–1819. doi:10.1364/OE.16.001808. PMID 18542260.
- [6] “Nick Holonyak, Jr. 2004 Lemelson-MIT Prize Winner”. Lemelson-MIT Program. Retrieved August 13, 2007.
- [7] Round, H. J. (1907). “A Note on Carborundum”. *Electrical World* **19**: 309.
- [8] Margolin J. “*The Road to the Transistor*”. *jmargolin.com*.
- [9] Losev, O. V. (1927). *Telegrafiya i Telefoniya bez Provodov* **44**: 485–494. Missing or empty title= (help)
- [10] Zheludev, N. (2007). “The life and times of the LED: a 100-year history” (FREE-DOWNLOAD PDF). *Nature Photonics* **1** (4): 189–192. Bibcode:2007NaPho...1..189Z. doi:10.1038/nphoton.2007.34.
- [11] Lee, Thomas H. (2004). *The design of CMOS radio-frequency integrated circuits*. Cambridge University Press. p. 20. ISBN 0-521-83539-9.
- [12] K. Lehovec, C. A. Accardo, AND E. Jamgochian (1951). “Injected Light Emission of Silicon Carbide Crystals” (FREE-DOWNLOAD HTML). *The Physical Review* **83** (3): 603–607. doi:10.1103/PhysRev.83.603.
- [13] K. Lehovec, C. A. Accardo, AND E. Jamgochian (1953). “Injected Light Emission of Silicon Carbide Crystals”. *The Physical Review* **89**: 20. doi:10.1103/PhysRev.89.20.
- [14] Rubin Braunstein. physics.ucla.edu
- [15] Braunstein, Rubin (1955). “Radiative Transitions in Semiconductors”. *Physical Review* **99** (6): 1892. Bibcode:1955PhRv...99.1892B. doi:10.1103/PhysRev.99.1892.
- [16] Kroemer, Herbert (Sep 16, 2013). “The Double-Heterostructure Concept: How It Got Started”. *Proceedings of the IEEE* **101** (10): 2183. doi:10.1109/JPROC.2013.2274914.
- [17] Timeline of LED Inventors and Developments
- [18] “The first LEDs were infrared (invisible)”. *The Quartz Watch*. The Lemelson Center. Retrieved August 13, 2007.
- [19] Holonyak Nick; Bevacqua, S. F. (December 1962). “Coherent (Visible) Light Emission from Ga(As_{1-x}P_x) Junctions”. *Applied Physics Letters* **1** (4): 82. Bibcode:1962ApPhL...1...82H. doi:10.1063/1.1753706.
- [20] Wolinsky, Howard (February 5, 2005). “U. of I.’s Holonyak out to take some of Edison’s luster”. *Chicago Sun-Times*. Archived from the original on February 28, 2008. Retrieved July 29, 2007.
- [21] Perry, T.S. (1995). “M. George Craford [biography]”. *IEEE Spectrum* **32** (2): 52–55. doi:10.1109/6.343989.
- [22] “Brief Biography — Holonyak, Craford, Dupuis” (PDF). Technology Administration. Retrieved May 30, 2007.
- [23] Pearsall, T. P.; Miller, B. I.; Capik, R. J.; Bachmann, K. J. (1976). “Efficient, Lattice-matched, Double Heterostructure LEDs at 1.1 μm from GaIn_{1-x}AsP_{1-y} by Liquid-phase Epitaxy”. *Appl. Phys. Lett.* **28** (9): 499. Bibcode:1976ApPhL..28..499P. doi:10.1063/1.88831.
- [24] Rostky, George (March 1997). “LEDs cast Monsanto in Unfamiliar Role”. *Electronic Engineering Times (EE-Times)* (944).
- [25] Schubert, E. Fred (2003). “1”. *Light-Emitting Diodes*. Cambridge University Press. ISBN 0-8194-3956-8.
- [26] US 3025589, “Method of Manufacturing Semiconductor Devices”, issued Mar 20, 1962
- [27] Patent number: 3025589 Retrieved May 17, 2013
- [28] Bausch, Jeffrey (December 2011). “The Long History of Light Emitting Diodes”. Hearst Business Communications.

- [29] Park, S. -I.; Xiong, Y.; Kim, R. -H.; Elvikis, P.; Meitl, M.; Kim, D. -H.; Wu, J.; Yoon, J.; Yu, C. -J.; Liu, Z.; Huang, Y.; Hwang, K. -C.; Ferreira, P.; Li, X.; Choquette, K.; Rogers, J. A. (2009). "Printed Assemblies of Inorganic Light-Emitting Diodes for Deformable and Semitransparent Displays". *Science* **325** (5943): 977–981. doi:10.1126/science.1175690. PMID 19696346.
- [30] LED Thermal Management. Lunaraccents.com. Retrieved on March 16, 2012.
- [31] Nakamura, S.; Mukai, T. and Senoh, M. (1994). "Candela-Class High-Brightness InGaN/AlGaIn Double-Heterostructure Blue-Light-Emitting-Diodes". *Appl. Phys. Lett.* **64** (13): 1687. Bibcode:1994ApPhL..64.1687N. doi:10.1063/1.111832.
- [32] "The Nobel Prize in Physics 2014 Isamu Akasaki, Hiroshi Amano, Shuji Nakamura". *nobelprize.org*. The Royal Swedish Academy of Sciences. Retrieved 17 March 2015.
- [33] Dadgar, A.; Alam, A.; Riemann, T.; Bläsing, J.; Diez, A.; Poschenrieder, M.; Strassburg, M.; Heuken, M.; Christen, J.; Krost, A. (November 2001). "Crack-Free InGaN/GaN Light Emitters on Si(111)". *Physica status solidi (a)* **188** (1): 155–158. doi:10.1002/1521-396X(200111)188:1<155::AID-PSSA155>3.0.CO;2-P.
- [34] Dadgar, A.; Poschenrieder, M.; Bläsing, J.; Fehse, K.; Diez, A.; Krost, A. (2002). "Thick, crack-free blue light-emitting diodes on Si(111) using low-temperature AlN interlayers and in situ Si_xN_y masking". *Applied Physics Letters* **80** (20): 3670. Bibcode:2002ApPhL..80.3670D. doi:10.1063/1.1479455.
- [35] Success in research: First gallium-nitride LED chips on silicon in pilot stage at the Wayback Machine (archived September 15, 2012). www.osram.de, January 12, 2012
- [36] Colin J. Humphreys' cheap LED production method. Rsc.org (January 30, 2009). Retrieved on March 16, 2012.
- [37] "Haitz's law". *Nature Photonics* **1** (1): 23. 2007. Bibcode:2007NaPho...1...23.. doi:10.1038/nphoton.2006.78.
- [38] Morris Nick. "LED there be light, Nick Morris predicts a bright future for LEDs". Electrooptics.com. Retrieved 17 March 2015.
- [39] "The LED Illumination Revolution". *Forbes*. February 27, 2008.
- [40] Press Release, Official Nobel Prize website, 7 October 2014
- [41] Mueller, Gerd (2000) Electroluminescence I, Academic Press, ISBN 0-12-752173-9, p. 67, "escape cone of light" from semiconductor, illustrations of light cones on p. 69
- [42] "Optical Properties of Silicon". *pvcdrom.pveducation.org*.
- [43] Refraction — Snell's Law. Interactagram.com. Retrieved on March 16, 2012.
- [44] Lipták, Bela G. (2005) Instrument Engineers' Handbook: Process control and optimization, CRC Press, ISBN 0-8493-1081-4 p. 537, "cone of light" in context of optical fibers
- [45] Capper, Peter and Mauk, Michael (2007). *Liquid phase epitaxy of electronic, optical, and optoelectronic materials*. Wiley. p. 389. ISBN 0-470-85290-9. faceted structures are of interest for solar cells, LEDs, thermophotovoltaic devices, and detectors in that nonplanar surfaces and facets can enhance optical coupling and light-trapping effects, [with example microphotograph of a faceted crystal substrate].
- [46] Dakin, John and Brown, Robert G. W. (eds.) Handbook of optoelectronics, Volume 2, Taylor & Francis, 2006 ISBN 0-7503-0646-7 p. 356, "Die shaping is a step towards the ideal solution, that of a point light source at the center of a spherical semiconductor die."
- [47] Schubert, E. Fred (2006) Light-emitting diodes, Cambridge University Press, ISBN 0-521-86538-7 p. 97, "Epoxy Encapsulants", "The light extraction efficiency can be enhanced by using dome-shaped encapsulants with a large refractive index."
- [48] "All in 1 LED Lighting Solutions Guide", philipslumileds.com, p. 15.
- [49] "Nichia Unveils White LED with 150 lm/W Luminous Efficiency". Tech-On!. December 21, 2006. Retrieved August 13, 2007.
- [50] "Cree Sets New Record for White LED Efficiency", Tech-On, April 23, 2012.
- [51] "Cree First to Break 300 Lumens-Per-Watt Barrier", Cree news
- [52] *DOE Solid-State Lighting CALiPER Program Summary of Results: Round 9 of Product Testing*. (PDF). U.S. Department of Energy. October 2009.
- [53] Identifying the Causes of LED Efficiency Droop, By Steven Keeping, Digi-Key Corporation Tech Zone
- [54] Stevenson, Richard (August 2009) The LED's Dark Secret: Solid-state lighting won't supplant the lightbulb until it can overcome the mysterious malady known as droop. *IEEE Spectrum*
- [55] Justin Iveland, Lucio Martinelli, Jacques Peretti, James S. Speck, Claude Weisbuch. "Cause of LED Efficiency Droop Finally Revealed". *Physical Review Letters*, 2013. Science Daily. Retrieved 23 April 2013.
- [56] The LED's dark secret. EnergyDaily. Retrieved on March 16, 2012.
- [57] Smart Lighting: New LED Drops The 'Droop'. Sciencedaily.com (January 13, 2009). Retrieved on March 16, 2012.
- [58] Efremov, A. A.; Bochkareva, N. I.; Gorbunov, R. I.; Lavrinovich, D. A.; Rebane, Y. T.; Tarkhin, D. V.; Shreter, Y. G. (2006). "Effect of the joule heating on the quantum efficiency and choice of thermal conditions for high-power blue InGaN/GaN LEDs". *Semiconductors* **40** (5): 605. doi:10.1134/S1063782606050162.

- [59] A Roadmap to Efficient Green-Blue-Ultraviolet Light-Emitting Diodes, U.S. Naval Research Laboratory, 19 February 2014, Donna McKinney
- [60] Enabling high-voltage InGaN LED operation with ceramic substrate, //Semiconductor Today//, 11 February 2014, Mike Cooke
- [61] Lifetime of White LEDs at the Wayback Machine (archived April 10, 2009), US Department of Energy
- [62] Narendran, N. and Y. Gu (2005). “Life of LED-based white light sources”. *IEEE/OSA Journal of Display Technology* **1** (1): 167–171. Bibcode:2005JDisT...1..167N. doi:10.1109/JDT.2005.852510.
- [63] Conway, K. M. and J. D. Bullough. 1999. Will LEDs transform traffic signals as they did exit signs? Proceedings of the Illuminating Engineering Society of North America Annual Conference (pp. 1–9), New Orleans, Louisiana, August 9–11. New York, NY: Illuminating Engineering Society of North America.
- [64] Narendran, N., J. Brons, and J. Taylor. 2006. Energy-efficient Alternative for Commercial Refrigeration. Project report prepared for the New York State Energy Research and Development Authority.
- [65] ASSIST. 2008. Recommendations for Testing and Evaluating Luminaires for Refrigerated and Freezer Display Cases. Vol. 5, Issue 1. Troy, N.Y.: Lighting Research Center.
- [66] Narendran, N. 2006. Field Test DELTA Snapshots: LED Lighting In Freezer Cases. Troy, N.Y.: Lighting Research Center.
- [67] Gu, Y., A. Baker, and N. Narendran. 2007. Investigation of thermal management technique in blue LED airport taxiway fixtures. Seventh International Conference on Solid State Lighting, Proceedings of SPIE 6669: 66690U.
- [68] OSRAM: green LED. osram-os.com. Retrieved on March 16, 2012.
- [69] Koizumi, S.; Watanabe, K.; Hasegawa, M.; Kanda, H. (2001). “Ultraviolet Emission from a Diamond pn Junction”. *Science* **292** (5523): 1899–1901. doi:10.1126/science.1060258. PMID 11397942.
- [70] Kubota, Y.; Watanabe, K.; Tsuda, O.; Taniguchi, T. (2007). “Deep Ultraviolet Light-Emitting Hexagonal Boron Nitride Synthesized at Atmospheric Pressure”. *Science* **317** (5840): 932–934. doi:10.1126/science.1144216. PMID 17702939.
- [71] Watanabe, K.; Taniguchi, T.; Kanda, H. (2004). “Direct-bandgap properties and evidence for ultraviolet lasing of hexagonal boron nitride single crystal”. *Nature Materials* **3** (6): 404–409. Bibcode:2004NatMa...3..404W. doi:10.1038/nmat1134. PMID 15156198.
- [72] Taniyasu, Y.; Kasu, M.; Makimoto, T. (2006). “An aluminium nitride light-emitting diode with a wavelength of 210 nanometres”. *Nature* **441** (7091): 325–328. doi:10.1038/nature04760. PMID 16710416.
- [73] “LEDs move into the ultraviolet”. physicsworld.com. May 17, 2006. Retrieved August 13, 2007.
- [74] How to Wire/Connect LEDs. Llama.com. Retrieved on March 16, 2012.
- [75] LED types by Color, Brightness, and Chemistry. Donkliststein.com. Retrieved on March 16, 2012.
- [76] “Nobel Shocker: RCA Had the First Blue LED in 1972”. *IEEE Spectrum*. October 9, 2014
- [77] “Oregon tech CEO says Nobel Prize in Physics overlooks the actual inventors”. *The Oregonian*. October 16, 2014
- [78] Schubert, E. Fred *Light-emitting diodes 2nd ed.*, Cambridge University Press, 2006 ISBN 0-521-86538-7 pp. 16–17
- [79] Maruska, H. (2005). “A Brief History of GaN Blue Light-Emitting Diodes”. *LIGHTimes Online - LED Industry News*.
- [80] Major Business and Product Milestones. Cree.com. Retrieved on March 16, 2012.
- [81] “GaN-based blue light emitting device development by Akasaki and Amano” (PDF). *Takeda Award 2002 Achievement Facts Sheet*. The Takeda Foundation. April 5, 2002. Retrieved November 28, 2007.
- [82] Iwasa, Naruhito; Mukai, Takashi and Nakamura, Shuji U.S. Patent 5,578,839 “Light-emitting gallium nitride-based compound semiconductor device” Issue date: November 26, 1996
- [83] 2006 Millennium technology prize awarded to UCSB’s Shuji Nakamura. Ia.ucsb.edu (June 15, 2006). Retrieved on March 16, 2012.
- [84] Overbye, Dennis (7 October 2014). “Nobel Prize in Physics”. *New York Times*. Retrieved 7 October 2014.
- [85] “The Nobel Prize in Physics 2014 - Press release”. *www.nobelprize.org*. Retrieved October 7, 2014.
- [86] Jonathan Webb (7 October 2014). “Invention of blue LEDs wins physics Nobel”. BBC News.
- [87] Cooke, Mike (April–May 2010). “Going Deep for UV Sterilization LEDs” (PDF). *Semiconductor Today* **5** (3): 82.
- [88] Mori, M.; Hamamoto, A.; Takahashi, A.; Nakano, M.; Wakikawa, N.; Tachibana, S.; Ikehara, T.; Nakaya, Y.; Akutagawa, M.; Kinouchi, Y. (2007). “Development of a new water sterilization device with a 365 nm UV-LED”. *Medical & Biological Engineering & Computing* **45** (12): 1237–1241. doi:10.1007/s11517-007-0263-1. PMID 17978842.
- [89] Wold, J. H. and Valberg, A. (2000). “The derivation of XYZ tristimulus spaces: A comparison of two alternative methods”. *Color Research & Application* **26** (S1): S222. doi:10.1002/1520-6378(2001)26:1+<::AID-COL47>3.0.CO;2-4.

- [90] Bessho, M and Shimizu, K (2012). "Latest trends in LED lighting". *Electronics and Communications in Japan* **95** (1): 1. doi:10.1002/ecj.10394.
- [91] Moreno, I.; Contreras, U. (2007). "Color distribution from multicolor LED arrays". *Optics express* **15** (6): 3607–3618. doi:10.1364/OE.15.003607. PMID 19532605.
- [92] Schubert, E. Fred and Kim, Jong Kyu (2005). "Solid-State Light Sources Getting Smart". *Science* **308** (5726): 1274. Bibcode:2005Sci...308.1274S. doi:10.1126/science.1108712.
- [93] Thomas Nimz, Fredrik Hailer and Kevin Jensen (2012). *Sensors and Feedback Control of Multi-Color LED Systems* (PDF). LED Professional. pp. 2–5. ISSN 1993-890X.
- [94] Tanabe, S. and Fujita, S. and Yoshihara, S. and Sakamoto, A. and Yamamoto, S. (2005). "YAG glass-ceramic phosphor for white LED (II): luminescence characteristics" (PDF). *Proc. Of SPIE. Fifth International Conference on Solid State Lighting* **5941**: 594112. doi:10.1117/12.614681.
- [95] Ohno, Y. (2004). "Color rendering and luminous efficacy of white LED spectra" (PDF). *Proc. Of SPIE. Fourth International Conference on Solid State Lighting* **5530**: 89. doi:10.1117/12.565757.
- [96] Whitaker, Tim (December 6, 2002). "Joint venture to make ZnSe white LEDs". Retrieved January 3, 2009.
- [97] Next-Generation GaN-on-Si White LEDs Suppress Costs, *Electronic Design*, 19 November 2013
- [98] GaN-on-Silicon LEDs Forecast to Increase Market Share to 40 Percent by 2020, *iSuppli*, 4 December 2013
- [99] Burroughes, J. H.; Bradley, D. D. C.; Brown, A. R.; Marks, R. N.; MacKay, K.; Friend, R. H.; Burns, P. L.; Holmes, A. B. (1990). "Light-emitting diodes based on conjugated polymers". *Nature* **347** (6293): 539. doi:10.1038/347539a0.
- [100] Bardsley, J. N. (2004). "International OLED Technology Roadmap". *IEEE Journal of Selected Topics in Quantum Electronics* **10**: 3–4. doi:10.1109/JSTQE.2004.824077.
- [101] Hebner, T. R.; Wu, C. C.; Marcy, D.; Lu, M. H.; Sturm, J. C. (1998). "Ink-jet printing of doped polymers for organic light emitting devices". *Applied Physics Letters* **72** (5): 519. Bibcode:1998ApPhL..72..519H. doi:10.1063/1.120807.
- [102] Bharathan, J.; Yang, Y. (1998). "Polymer electroluminescent devices processed by inkjet printing: I. Polymer light-emitting logo". *Applied Physics Letters* **72** (21): 2660. Bibcode:1998ApPhL..72.2660B. doi:10.1063/1.121090.
- [103] Gustafsson, G.; Cao, Y.; Treacy, G. M.; Klavetter, F.; Colaneri, N.; Heeger, A. J. (1992). "Flexible light-emitting diodes made from soluble conducting polymers". *Nature* **357** (6378): 477. doi:10.1038/357477a0.
- [104] Quantum-dot LED may be screen of choice for future electronics Massachusetts Institute of Technology News Office, December 18, 2002
- [105] Colvin, V. L.; Schlamp, M. C.; Alivisatos, A. P. (1994). "Light-emitting diodes made from cadmium selenide nanocrystals and a semiconducting polymer". *Nature* **370** (6488): 354. doi:10.1038/370354a0.
- [106] "Accidental Invention Points to End of Light Bulbs". LiveScience.com. October 21, 2005. Retrieved January 24, 2007.
- [107] Nanoco Signs Agreement with Major Japanese Electronics Company, September 23, 2009
- [108] Nanotechnologie Aktuell, pp. 98–99, v. 4, 2011, ISSN 1866-4997
- [109] Hoshino, K.; Gopal, A.; Glaz, M. S.; Vanden Bout, D. A.; Zhang, X. (2012). "Nanoscale fluorescence imaging with quantum dot near-field electroluminescence". *Applied Physics Letters* **101** (4): 043118. Bibcode:2012ApPhL.101d3118H. doi:10.1063/1.4739235.
- [110] Inman, Mason (February 1, 2008). "Crystal coat warms up LED light". newsscientist.com. Retrieved January 30, 2012.
- [111] What is the difference between 3528 LEDs and 5050 LEDs ISMD 5050 SMD 3528. Flexfireleds.com. Retrieved on March 16, 2012.
- [112] LED-design. Elektor.com. Retrieved on March 16, 2012.
- [113] Researchers build thinnest-known LED, The State Column, 10 March 2014, Aaron Sims
- [114] "Luminus Products". Luminus Devices, Inc. Retrieved October 21, 2009.
- [115] "Luminus Products CST-90 Series Datasheet" (PDF). Luminus Devices, Inc. Retrieved October 25, 2009.
- [116] Poensgen, Tobias (January 22, 2013) InfiniLED MicroLEDs achieve Ultra-High Light Intensity. infiniled.com
- [117] Xlamp Xp-G Led. Cree.com. Retrieved on March 16, 2012.
- [118] High Power Point Source White Led NVSx219A. Nichia.co.jp, November 2, 2010.
- [119] "Seoul Semiconductor launches AC LED lighting source Acrich". LEDS Magazine. November 17, 2006. Retrieved February 17, 2008.
- [120] *Visibility, Environmental, and Astronomical Issues Associated with Blue-Rich White Outdoor Lighting* (PDF). International Dark-Sky Association. May 4, 2010.
- [121] Windell. "Some thoughts on throwies". evilmadscientist.com, September 16, 2009
- [122] Schubert, E. Fred (2005). "Chapter 4". *Light-Emitting Diodes*. Cambridge University Press. ISBN 0-8194-3956-8.
- [123] "Visible LED Device Classifications". Datasheetarchive.com. Retrieved on March 16, 2012.

- [124] Opinion of the French Agency for Food, Environmental and Occupational Health & Safety, ANSES Opinion, October 19, 2010.
- [125] “Eye Safety and LED (Light Emitting Diode) diffusion”: “The relevant standard for LED lighting is EN 60825-1:2001 (Safety of laser products) ... The standard states that throughout the standard “light emitting diodes (LED) are included whenever the word “laser” is used.”
- [126] Lim, S. R.; Kang, D.; Ogunseitan, O. A.; Schoenung, J. M. (2011). “Potential Environmental Impacts of Light-Emitting Diodes (LEDs): Metallic Resources, Toxicity, and Hazardous Waste Classification”. *Environmental Science & Technology* **45** (1): 320–327. doi:10.1021/es101052q. PMID 21138290.
- [127] “Solid-State Lighting: Comparing LEDs to Traditional Light Sources”. *eere.energy.gov*.
- [128] “Dialight Micro LED SMD LED “598 SERIES” Datasheet” (PDF). *dialight.com*.
- [129] “Data Sheet — HLMP-1301, T-1 (3 mm) Diffused LED Lamps”. Avago Technologies, Inc. Retrieved May 30, 2010.
- [130] Narra, Prathyusha and Zinger, D.S. (2004). “An effective LED dimming approach”. *Industry Applications Conference, 2004. 39th IAS Annual Meeting. Conference Record of the 2004 IEEE* **3**: 1671–1676. doi:10.1109/IAS.2004.1348695. ISBN 0-7803-8486-5.
- [131] Lifetime of White LEDs. US Department of Energy. (PDF) . Retrieved on March 16, 2012.
- [132] “In depth: Advantages of LED Lighting”. *energy.ltgovernors.com*.
- [133] “LED Lighting Explained: Questions and Answers”. *energy.ltgovernors.com*.
- [134] <http://www.philipslumileds.com/uploads/news/id228/PR211.pdf>
- [135] The Led Museum. The Led Museum. Retrieved on March 16, 2012.
- [136] Worthey, James A. “How White Light Works”. *LRO Lighting Research Symposium, Light and Color*. Retrieved October 6, 2007.
- [137] Hecht, E. (2002). *Optics* (4 ed.). Addison Wesley. p. 591. ISBN 0-19-510818-3.
- [138] “Blue LEDs: A health hazard?”. *texyt.com*. January 15, 2007. Retrieved September 3, 2007.
- [139] Raloff, Janet (May 27, 2006). “Light Impacts: Science News”. *Sciencenews.org*.
- [140] Efremov, A. A.; Bochkareva, N. I.; Gorbunov, R. I.; Lavrinovich, D. A.; Rebane, Y. T.; Tarkhin, D. V.; Shreter, Y. G. (2006). “Effect of the joule heating on the quantum efficiency and choice of thermal conditions for high-power blue InGaN/GaN LEDs”. *Semiconductors* **40** (5): 605. doi:10.1134/S1063782606050162.
- [141] “LEDs: Good for prizes, bad for insects”. *news.sciencemag.org*. 7 October 2014. Retrieved 7 October 2014.
- [142] “LED lighting increases the ecological impact of light pollution irrespective of color temperature”. Retrieved January 2015.
- [143] <http://abcnews.go.com/GMA/ConsumerNews/led-traffic-lights-unusual-potentially-deadly-winter-problem/story?id=9506449>
- [144] <https://www.cars.com/articles/2009/12/led-traffic-lights-cant-melt-snow-ice/>
- [145] European Photonics Industry Consortium (EPIC). This includes use in data communications over fiber optics as well as “broadcast” data or signaling.
- [146] Forrest M. Mims III. “An Inexpensive and Accurate Student Sun Photometer with Light-Emitting Diodes as Spectrally Selective Detectors”. (1998 ?)
- [147] “Water Vapor Measurements with LED Detectors”. *cs.drexel.edu* (2002).
- [148] Dziekan, Mike (February 6, 2009) “Using Light-Emitting Diodes as Sensors”. *soamsci.or*.
- [149] Ben-ezra, Moshe; Wang, Jiaping; Wilburn, Bennett; Li, Xiaoyang and Ma, Le. “An LED-only BRDF Measurement Device”
- [150] LED advantages outweigh potential snow hazards in traffic signals, LEDs magazine January 7, 2010
- [151] “L-Prize U.S. Department of Energy”, L-Prize Website, August 3, 2011
- [152] LED There Be Light, Scientific American, March 18, 2009
- [153] Eisenberg, Anne (June 24, 2007). “In Pursuit of Perfect TV Color, With L.E.D.’s and Lasers”. *New York Times*. Retrieved April 4, 2010.
- [154] “CDC - NIOSH Publications and Products - Impact: NIOSH Light-Emitting Diode (LED) Cap Lamp Improves Illumination and Decreases Injury Risk for Underground Miners”. *cdc.gov*. Retrieved May 3, 2013.
- [155] “LED Device Illuminates New Path to Healing” (Press release). *nasa.gov*. Retrieved January 30, 2012.
- [156] Green, Hank (October 9, 2008). “Transmitting Data Through LED Light Bulbs”. *EcoGeek*. Retrieved February 15, 2009.
- [157] *DOE Solid-State Lighting CALiPER Program Summary of Results: Round 7 of Product Testing* (PDF). U.S. Department of Energy. February 2009.
- [158] US DOE EIA: Electricity Emission Factors. *Eia.doe.gov*. Retrieved on March 16, 2012.
- [159] Dietz, Yerazunis, and Leigh (2004). “Very Low-Cost Sensing and Communication Using Bidirectional LEDs”.

- [160] Goins, GD and Yorio, NC and Sanwo, MM and Brown, CS (1997). “Photomorphogenesis, photosynthesis, and seed yield of wheat plants grown under red light-emitting diodes (LEDs) with and without supplemental blue lighting”. *Journal of Experimental Botany* **48** (7): 1407. doi:10.1093/jxb/48.7.1407.

6.10 Further reading

- Shuji Nakamura, Gerhard Fasol, Stephen J Pearton (2000). *The Blue Laser Diode: The Complete Story*. Springer Verlag. ISBN 3-540-66505-6.

6.11 External links

- Light-emitting diode at DMOZ

Chapter 7

Arc lamp

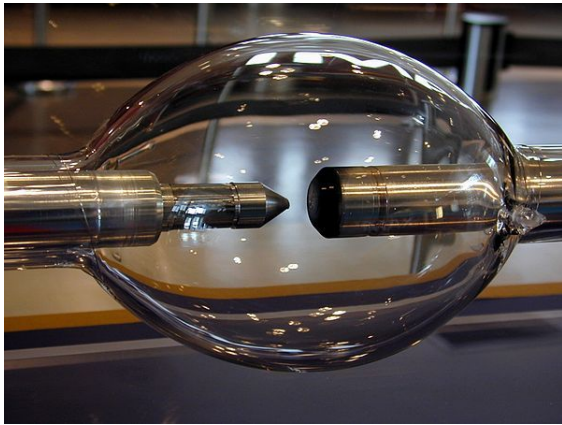

The 15 kW xenon short-arc lamp used in the IMAX projection system.



A mercury arc lamp from a fluorescence microscope.

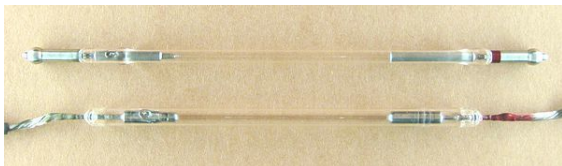

A krypton long arc lamp (top) is shown above a xenon flashtube. The two lamps, used for laser pumping, are very different in the shape of the electrodes, in particular, the cathode, (on the left).

An **arc lamp** or **arc light** is a lamp that produces light by an electric arc (also called a voltaic arc). The carbon arc

light, which consists of an arc between carbon electrodes in air, invented by Humphry Davy in the early 1800s, was the first practical electric light.^[1] It was widely used starting in the 1870s for street and large building lighting until it was superseded by the incandescent light in the early 20th century.^[1] It continued in use in more specialized applications where a high intensity point light source was needed, such as searchlights and movie projectors until after World War II. The carbon arc lamp is now obsolete for all of these purposes and is only still made for very specialized purposes where a high intensity UV source is needed.

The term is now used to refer to gas discharge lamps, which produce light by an arc between metal electrodes through an inert gas in a glass bulb. The common fluorescent lamp is a low-pressure mercury arc lamp.^[2] The xenon arc lamp, which produces a high intensity white light, is now used in many of the applications which formerly used the carbon arc, such as movie projectors and searchlights.

7.1 Operation

An *arc* is the discharge that occurs when a gas is ionized. A high voltage is pulsed across the lamp to “ignite” or “strike” the arc, after which the discharge can be maintained at a lower voltage. The “strike” requires an electrical circuit with an *igniter* and a *ballast*. The ballast is wired in series with the lamp and performs two functions.

First, when the power is first switched on, the igniter/starter (which is wired in parallel across the lamp) sets up a small current through the ballast and starter. This creates a small magnetic field within the ballast windings. A moment later the starter interrupts the current flow from the ballast, which has a high inductance and therefore tries to maintain the current flow (the ballast opposes any change in current through it); it cannot, as there is no longer a 'circuit'. As a result, a high voltage appears across the ballast momentarily - to which the lamp is connected, therefore the lamp receives this high voltage across it which 'strikes' the arc within the tube/lamp. The circuit will repeat this action until the lamp is ionized

enough to sustain the arc.

When the lamp sustains the arc, the ballast performs its second function, to limit the current to that needed to operate the lamp. The lamp, ballast and igniter are rated matched to each other; these parts must be replaced with the same rating as the failed component or the lamp will not work.

The colour of the light emitted by the lamp changes as its electrical characteristics change with temperature and time. **Lightning** is a similar principle where the atmosphere is ionized by the high potential difference (voltage) between earth and storm clouds.

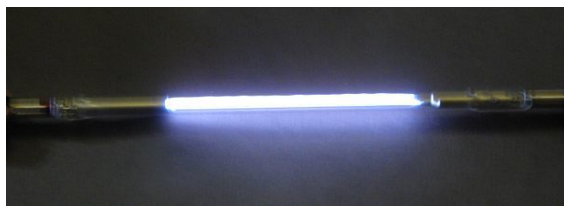

A krypton arc lamp during operation.

The temperature of the arc in an arc lamp can reach several thousand degrees Celsius. The outer glass envelope can reach 500 degrees Celsius, therefore before servicing one must ensure the bulb has cooled sufficiently to handle. Often, if these types of lamps are turned off or lose their power supply, one cannot restrike the lamp again for several minutes (called cold restrike lamps). However, some lamps (mainly fluorescent tubes/energy saving lamps) can be restripped as soon as they are turned off (called hot restrike lamps).

The Vortek water-wall plasma arc lamp, invented in 1975 by David Camm and Roy Nodwell at the University of British Columbia Vancouver, Canada, made the Guinness Book of World Records in 1986 and 1993 as the most powerful continuously burning light source at over 300 kW or 1.2 million candle power.^[3]

7.2 Carbon arc lamp

In popular use, the term *arc lamp* means *carbon arc lamp* only. In a **carbon arc lamp**, the electrodes are carbon rods in free air. To ignite the lamp, the rods are touched together, thus allowing a relatively low voltage to strike the arc.^[1] The rods are then slowly drawn apart, and electric current heats and maintains an arc across the gap. The tips of the carbon rods are heated and the carbon vaporizes. The carbon vapor in the arc is highly luminous, which is what produces the bright light.^[1] The rods are slowly burnt away in use, and the distance between them needs to be regularly adjusted in order to maintain the arc.^[1] Many ingenious mechanisms were invented to effect this automatically, mostly based on solenoids. In one of the simplest mechanically-regulated forms (which was



A carbon arc lamp, cover removed, on the point of ignition. This model requires manual adjustment of the electrodes



An electric arc, demonstrating the "arch" effect.

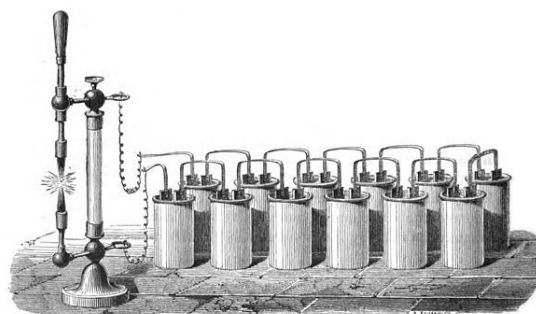

Early experimental carbon arc light powered by liquid batteries, similar to Davy's

soon superseded by more smoothly acting devices) the electrodes are mounted vertically. The current supplying the arc is passed in series through a solenoid attached to the top electrode. If the points of the electrodes are touching (as in start up) the resistance falls, the current increases and the increased pull from the solenoid draws the points apart. If the arc starts to fail the current drops and the points close up again. The Yablochkov candle is

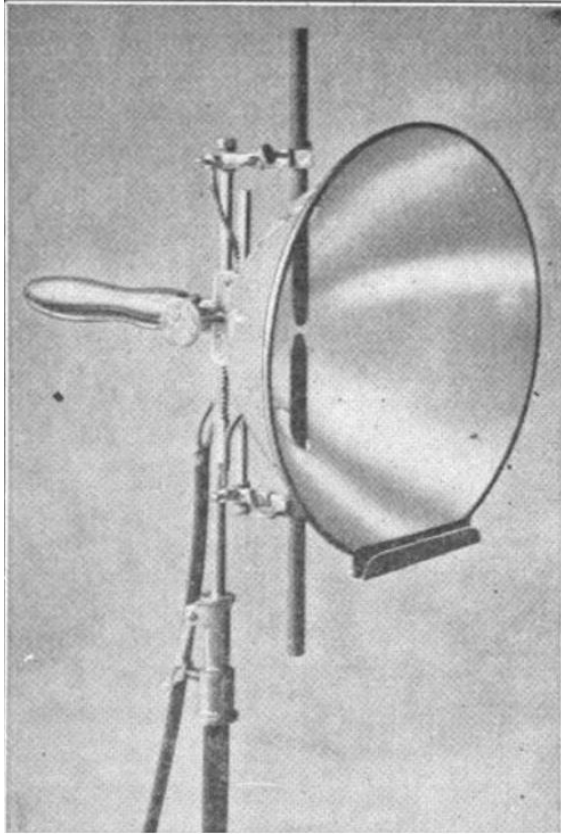

Medical carbon arc lamp used to treat skin conditions, 1909

a simple arc lamp without a regulator, but it has the drawbacks that the arc cannot be restarted (single use) and a limited lifetime.

7.3 History

The concept of carbon-arc lighting was first demonstrated by Sir Humphry Davy in the early 19th century (1802, 1805, 1807 and 1809 are all mentioned), using charcoal sticks and a 2000-cell battery to create an arc across a 4-inch (100 mm) gap. He mounted his electrodes horizontally and noted that, because of the strong convection flow of air, the arc formed the shape of an arch. He coined the term “arch lamp”, which was contracted to “arc lamp” when the devices came into common usage.^[4]

The arc lamp provided one of the first commercial uses for electricity, a phenomenon previously confined to experiment, the telegraph, and entertainment.^[5]

7.3.1 Carbon-arc lighting in the U.S.

In the United States, there were attempts to produce arc lamps commercially after 1850 but the lack of a constant electricity supply thwarted efforts. Thus electrical engineers began focusing on the problem of improving Faraday’s dynamo. The concept was improved upon by

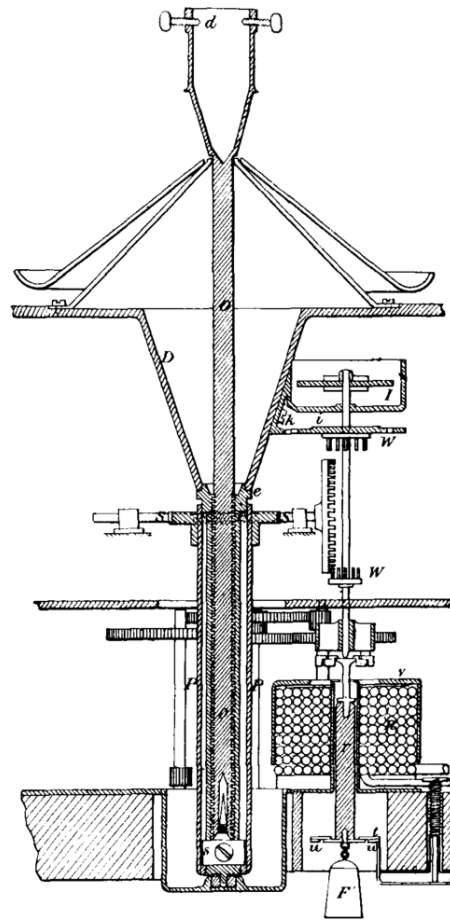

Self-regulating arc lamp proposed by William Edwards Staite and William Petrie in 1847

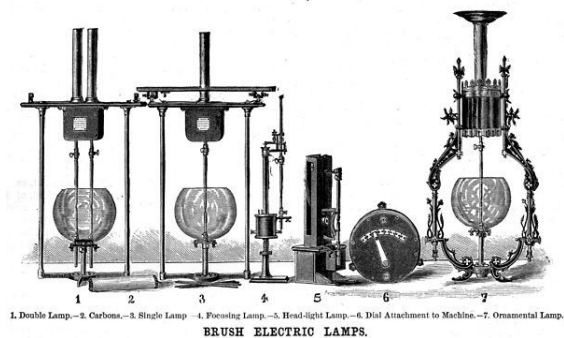

a number of people including William Staite and Charles F. Brush. It was not until the 1870s that lamps such as the Yablochkov candle were more commonly seen. In 1877, the Franklin Institute conducted a comparative test of dynamo systems. The one developed by Brush performed best, and Brush immediately applied his improved dynamo to arc-lighting an early application being Public Square in Cleveland, Ohio, on April 29, 1879.^[6] In 1880, Brush established the Brush Electric Company.

The harsh and brilliant light was found most suitable for public areas, such as Cleveland's Public Square, being around 200 times more powerful than contemporary filament lamps.

The usage of Brush electric arc lights spread quickly. *Scientific American* reported in 1881 that the system was being used in:^[7]

- 800 lights in rolling mills, steel works, shops, etc.
- 1,240 lights in woolen, cotton, linen, silk, and other factories
- 425 lights in large stores, hotels, churches, etc.
- 250 lights in parks, docks, and summer resorts
- 275 lights in railroad depots and shops
- 130 lights in mines, smelting works, etc.
- 380 lights in factories and establishments of various kinds
- 1,500 lights in lighting stations, for city lighting, etc.
- 1,200 lights in England and other foreign countries.
- A total of over 6,000 lights which are actually sold

There were three major advances in the 1880s:

- The arcs were enclosed in a small tube to slow the carbon consumption (increasing the life span to around 100 hours).
- *Flame arc lamps* were introduced where the carbon rods had metal salts (usually magnesium, strontium, barium, or calcium fluorides) added to increase light output and produce different colours.
- **František Křižík** invented a mechanism to allow the automatic adjustment of the electrodes.

In the U.S., patent protection of arc-lighting systems and improved dynamos proved difficult and as a result the arc-lighting industry became highly competitive. Brush's principal competition was from the team of **Elihu Thomson** and **Edwin J. Houston**. These two had formed the **American Electric Corporation** in 1880, but it was soon bought up by **Charles A. Coffin**, moved to Lynn, Massachusetts, and renamed the **Thomson-Houston Electric Company**. Thomson remained, though, the principal inventive genius behind the company patenting improvements to the lighting system. Under the leadership of Thomson-Houston's patent attorney, **Frederick P. Fish**, the company protected its new patent rights. Coffin's management also led the company towards an aggressive policy of buy-outs and mergers with competitors. Both strategies reduced competition in the electrical

lighting manufacturing industry. By 1890, the Thomson-Houston company was the dominant electrical manufacturing company in the U.S.^[8] **Nikola Tesla** received U.S. Patent 447920, "*Method of Operating Arc-Lamps*" (March 10, 1891), that describes a 10,000 cycles per second alternator to suppress the disagreeable sound of power-frequency harmonics produced by arc lamps operating on frequencies within the range of human hearing.

Around the turn of the century arc-lighting systems were in decline, but Thomson-Houston controlled key patents to urban lighting systems. This control slowed the expansion of incandescent lighting systems being developed by **Thomas Edison's Edison General Electric Company**. Conversely, Edison's control of direct current distribution and generating machinery patents blocked further expansion of Thomson-Houston. The roadblock to expansion was removed when the two companies merged in 1892 to form the **General Electric Company**.^[8]

Arc lamps were used in some early motion-picture studios to illuminate interior shots. One problem was that they produce such a high level of ultra-violet light that many actors needed to wear sunglasses when off camera to relieve sore eyes resulting from the ultra-violet light. The problem was solved by adding a sheet of ordinary window glass in front of the lamp, blocking the ultra-violet. By the dawn of the "talkies", arc lamps had been replaced in film studios with other types of lights. In 1915, **Elmer Ambrose Sperry** began manufacturing his invention of a high-intensity carbon arc searchlight. These were used aboard warships of all navies during the 20th century for signaling and illuminating enemies.^[9] In the 1920s, carbon arc lamps were sold as family health products, a substitute for natural sunlight.^[10]

Arc lamps were superseded by filament lamps in most roles, remaining in only certain niche applications such as **cinema projection**, **followspots**, and **searchlights**. Even in these applications conventional carbon arc lamps are being pushed into obsolescence by **xenon arc lamps**, but were still being manufactured as spotlights at least as late as 1982^[11] and are still manufactured for at least one purpose - simulating sunlight in "accelerated aging" machines intended to estimate how fast a material is likely to be degraded by environmental exposure.^{[12][13]}

7.4 See also

- Electric light
- Graphite
- High-intensity discharge lamp
- Large-format slide projector
- Léon Foucault
- List of light sources

- List of Nikola Tesla patents
- Movie projector
- Pavel Yablochkov
- Photolithography
- Praseodymium
- Shielded metal arc welding
- Stage lighting
- Timeline of lighting technology
- Walther Nernst

7.5 References

- [1] Whelan, M. (2013). “Arc Lamps”. *Resources*. [Edison Tech Center <http://www.edisontechcenter.org/>] website, Schenectady, New York. Retrieved November 22, 2014.
- [2] Chen, Kao (1990). “Fluorescent Lamps”. *Industrial Power Distribution and Illuminating Systems*. Electrical Engineering and Electronics **65**. New York: Dekker. p. 350. ISBN 978-0-8247-8237-5. The fluorescent lamp is ... activated by ... a low-pressure mercury arc.
- [3] Voyer, Roger (1994). *The New Innovators: How Canadians Are Shaping the Knowledge-Based Economy*. Toronto: James Lorimer & Company Ltd. p. 20. ISBN 1-55028-463-0.
- [4] Slingo, William; Brooker, Arthur (1900). *Electrical Engineering for Electric Light Artisans*. London: Longmans, Green and Co. p. 607. OCLC 264936769
- [5] Gilbert, Gerard. *Critic's Choice* The Independent, 6 October 2011
- [6] “Cleveland+ Public Art” (BROCHURE). Positively Cleveland. 2008. p. 3. Retrieved 2009-05-18.
- [7] “The Brush Electric Light”. *Scientific American* **44** (14). April 2, 1881.; also Ohio Memory Collection cover reproduction
- [8] David F. Noble, *America By Design: Science, Technology, and the Rise of Corporate Capitalism* (New York: Oxford University Press, 1977), 6-10.
- [9] I. C. B. Dear and Peter Kemp, eds., “Sperry, Elmer Ambrose,” *The Oxford Companion to Ships and the Sea*, 2nd ed. (New York: Oxford University Press, 2006). ISBN 0-19-920568-X
- [10] “Eveready Carbon Arc Sunshine Lamp Advertisements”. The Einhorn Press. Retrieved 11 November 2008.
- [11] <http://www.film-tech.com/manuals/STRSTRONGHIST.pdf>
- [12] <http://www.edisontechcenter.org/ArcLamps.html>
- [13] <http://www.sca-shinyei.com/suga>

7.6 Bibliography

- Braverman, Harry (1974). *Labor and Monopoly Capital*. New York: Monthly Review Press.
- MacLaren, Malcolm (1943). *The Rise of the Electrical Industry during the Nineteenth Century*. Princeton: Princeton University Press.
- Noble, David F. (1977). *America by Design: Science, Technology, and the Rise of Corporate Capitalism*. New York: Oxford University Press. pp. 6–10.
- Prasser, Harold C. (1953). *The Electrical Manufacturers*. Cambridge: Harvard University Press.

7.7 External links

- Arc Lamp - Interactive Tutorial National High Magnetic Field Laboratory

Chapter 8

Xenon arc lamp

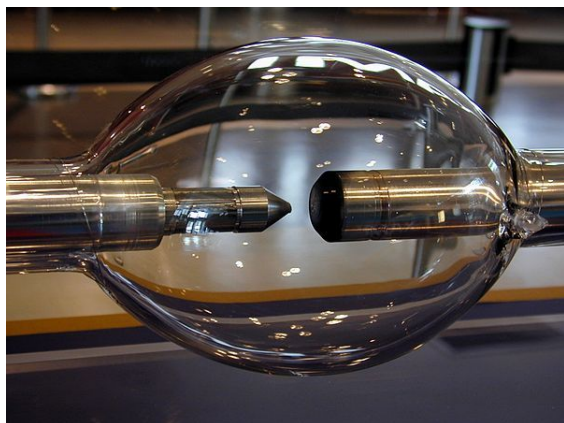

15 kW xenon short-arc lamp used in IMAX projectors

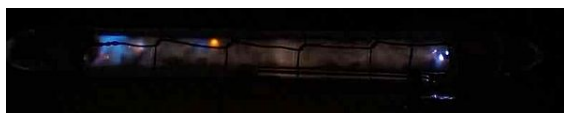

High-speed, slow-motion video of a xenon flashtube. Camera was recording at 44,025 frames per second.

A **xenon arc lamp** is a specialized type of gas discharge lamp, an electric light that produces light by passing electricity through ionized xenon gas at high pressure. It produces a bright white light that closely mimics natural sunlight. Xenon arc lamps are used in movie projectors in theaters, in searchlights, and for specialized uses in industry and research to simulate sunlight. Xenon headlamps in automobiles actually use metal-halide lamps where a xenon arc is only used during start-up.

8.1 Types

Xenon arc lamps can be roughly divided into three categories:

- Continuous-output xenon short-arc lamps
- Continuous-output xenon long-arc lamps
- Xenon flash lamps (which are usually considered separately)

Each consists of a fused quartz or other heat resistant glass arc tube, with a tungsten metal electrode at each end. The glass tube is first evacuated and then re-filled with xenon gas. For xenon flashtubes, a third “trigger” electrode usually surrounds the exterior of the arc tube. The lamp has a lifetime of around 2000 hours.

8.2 History and modern usage



An Osram 100 W xenon/mercury short-arc lamp in reflector

Xenon short-arc lamps were invented in the 1940s in Germany and introduced in 1951 by Osram. First launched in the 2 kW size (XBO2001), these lamps saw wide use in movie projection, where they replaced the older, more complicated carbon arc lamps. The white continuous light generated by the xenon arc is spectrally similar to daylight, but the lamp has a rather low efficiency in terms of lumens of visible light output per watt of input power. Today, almost all movie projectors in theaters employ these lamps, with power ratings ranging from 900 watts up to 12 kW. Omnimax (Imax Dome) projection systems use single xenon lamps with ratings as high as 15 kW.

8.3 Lamp construction



An end-view of a 15 kW IMAX lamp showing the liquid-cooling ports

All modern xenon short-arc lamps use a fused quartz envelope with **thoriated tungsten** electrodes. Fused quartz is the only economically feasible material currently available that can withstand the high pressure (25 atmospheres for an IMAX bulb) and high temperature present in an operating lamp, while still being optically clear. The **thorium** dopant in the electrodes greatly enhances their **electron emission** characteristics. Because tungsten and quartz have different **coefficients of thermal expansion**, the tungsten electrodes are welded to strips of pure **molybdenum** metal or Invar alloy, which are then melted into the quartz to form the envelope seal.

Because of the very high power levels involved, large lamps are water-cooled. In those used in IMAX projectors, the electrode bodies are made from solid Invar and tipped with thoriated tungsten. An **O-ring** seals off the tube, so that the naked electrodes do not contact the water. In low power applications the electrodes are too cold for efficient electron emission and are not cooled; in high power applications an additional water cooling circuit for each electrode is necessary. To save costs, the water circuits are often not separated and the water needs to be **deionized** to make it electrically non-conductive, which, in turn, lets the quartz or some laser media dissolve into the water.

In order to achieve maximum efficiency, the xenon gas inside short-arc lamps is maintained at an extremely high pressure — up to 30 atmospheres (440 psi / 3040 kPa) — which poses safety concerns. If a lamp is dropped, or ruptures while in service, pieces of the lamp envelope can be thrown at high speed. To mitigate this, large xenon short-arc lamps are normally shipped in protective shields, which will contain the envelope fragments should breakage occur. Normally, the shield is removed once the lamp is installed in the lamp housing. When the lamp reaches the end of its useful life, the protective shield is put back on the lamp, and the spent lamp is then removed from the equipment and discarded. As

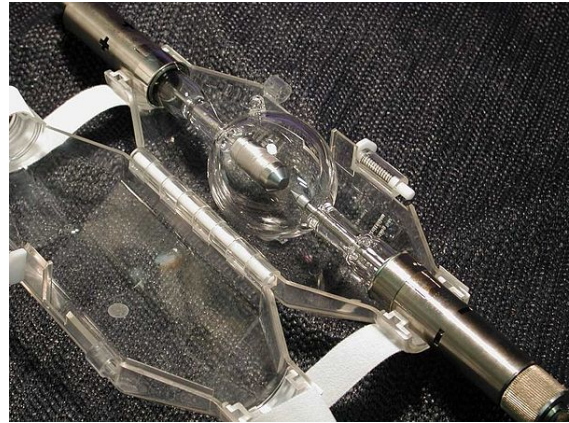

Perspective view of 3 kW lamp showing plastic safety shield used during shipping.

lamps age, the risk of failure increases, so bulbs being replaced are at the greatest risk of explosion. Because of the safety concerns, lamp manufacturers recommend the use of eye protection when handling xenon short-arc lamps. Because of the danger, some lamps, especially those used in IMAX projectors, require the use of full-body protective clothing.

8.4 Light generation mechanism

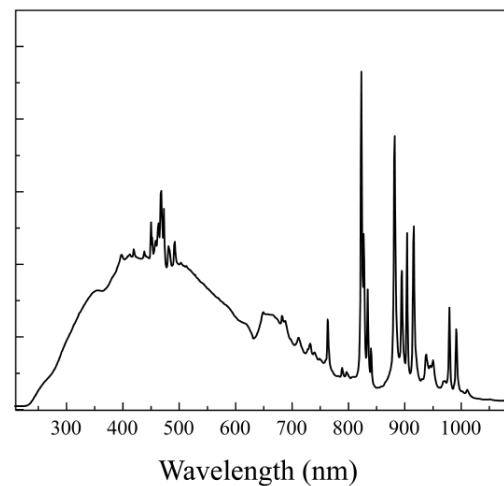

Output profile of a xenon arc lamp.

Xenon short-arc lamps come in two distinct varieties: pure xenon, which contain only xenon gas; and xenon-mercury, which contain xenon gas and a small amount of **mercury** metal.

In a pure xenon lamp, the majority of the light is generated within a tiny, pinpoint-sized cloud of plasma situated where the electron stream leaves the face of the cathode. The light generation volume is cone-shaped, and the lu-

minous intensity falls off exponentially moving from cathode to anode. Electrons passing through the plasma cloud strike the anode, causing it to heat. As a result, the anode in a xenon short-arc lamp either has to be much larger than the cathode or be water-cooled, to dissipate the heat. The output of a pure xenon short-arc lamp offers fairly continuous spectral power distribution with a color temperature of about 6200K and color rendering index close to 100.^[1] However, even in a high pressure lamp there are some very strong emission lines in the near infrared, roughly in the region from 850–900 nm. This spectral region can contain about 10% of the total emitted light. Light intensity ranges from 20,000 to 500,000 cd/cm². An example is “XBO lamp”, which is an OSRAM trade name for pure xenon short-arc lamp.^[1]

For some applications such as endoscopy and dental technology light guide systems are included.

In xenon-mercury short-arc lamps, the majority of the light is generated in a pinpoint-sized cloud of plasma situated at the tip of each electrode. The light generation volume is shaped like two intersecting cones, and the luminous intensity falls off exponentially moving towards the centre of the lamp. Xenon-mercury short-arc lamps have a bluish-white spectrum and extremely high UV output. These lamps are used primarily for UV curing applications, sterilizing objects, and generating ozone.

The very small size of the arc makes it possible to focus the light from the lamp with moderate precision. For this reason, xenon arc lamps of smaller sizes, down to 10 watts, are used in optics and in precision illumination for microscopes and other instruments, although in modern times they are being displaced by single mode laser diodes and white light supercontinuum lasers which can produce a truly diffraction limited spot. Larger lamps are employed in searchlights where narrow beams of light are generated, or in film production lighting where daylight simulation is required.

All xenon short-arc lamps generate substantial ultraviolet radiation. Xenon has strong spectral lines in the UV bands, and these readily pass through the fused quartz lamp envelope. Unlike the borosilicate glass used in standard lamps, fused quartz readily passes UV radiation unless it is specially doped. The UV radiation released by a short-arc lamp can cause a secondary problem of ozone generation. The UV radiation strikes oxygen molecules in the air surrounding the lamp, causing them to ionize. Some of the ionized molecules then recombine as O₃, ozone. Equipment that uses short-arc lamps as the light source must contain UV radiation and prevent ozone build-up.

Many lamps have a shortwave UV blocking coating on the envelope and are sold as “ozone free” lamps for solar simulators applications. The company WACOM has also a long history of xenon lamp production.^[2] Some lamps have envelopes made out of ultra-pure synthetic fused silica (such as “Suprasil”), which roughly doubles the cost,

but which allows them to emit useful light into the vacuum UV region. These lamps are normally operated in a pure nitrogen atmosphere.

8.5 Ceramic xenon lamps



A Cermax 2 kW xenon lamp from a video projector. A pair of heatsinks are clamped on the two metal bands around the perimeter, which also double to supply power to the lamp

Xenon short-arc lamps also are manufactured with a ceramic body and an integral reflector. They are available in many output power ratings with either UV-transmitting or blocking windows. The reflector options are parabolic (for collimated light) or elliptical (for focused light). They are used in a wide variety of applications, such as video projectors, fiber optic illuminators, endoscope and headlamp lighting, dental lighting, and search lights.

8.6 Power supply requirements

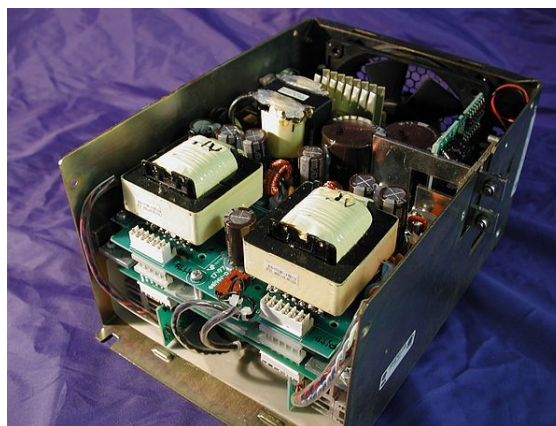

A 1 kW xenon short-arc lamp power supply with the cover removed.

Xenon short-arc lamps have a negative temperature coefficient like other gas discharge lamps. They are operated

at low-voltage, high-current, DC and started with a high voltage pulse of 20 to 50kV. As an example, a 450 W lamp operates normally at 18 V and 25 A once started. They are also inherently unstable, prone to phenomena such as **plasma oscillation** and **thermal runaway**. Because of these characteristics, xenon short-arc lamps require a proper power supply.

8.7 Automotive headlamps

In 1991 "xenon headlamps" were introduced for vehicles (BMW E32). These are actually **metal-halide lamps**; the xenon gas is used only to provide some light immediately upon lamp startup, as required for safety in an automotive headlamp application. Full intensity is reached 20 to 30 seconds later once the salts of **sodium** and **scandium** are vapourised by the heat of the xenon arc. The lamp envelope is small and the arc spans only a few **millimetres**. An outer hard glass tube blocks the escape of ultraviolet radiation that would tend to damage plastic headlamp components. The first xenon headlamps contained mercury; newer types do not.

8.8 Xenon long-arc-lamps

These are structurally similar to short-arc lamps except that the arc-containing portion of the glass tube is greatly elongated. When mounted within an **elliptical** reflector, these lamps are frequently used to simulate sunlight. Typical uses include **solar cell testing**, **solar simulation** for age testing of materials, rapid thermal processing, and material inspection.

8.9 See also

- List of light sources

8.10 References

- [1] "OSRAM SYVLANIA XBO" (PDF).
- [2] "WACOM KXL" (PDF).

8.11 External links

Chapter 9

Ultra-high-performance lamp

For other uses, see **UHP** (disambiguation).

The **Ultra-High-Performance lamp**, a high-pressure mercury arc lamp often known by the Philips trademark **UHP**, was originally known as the **ultra-high-pressure lamp**.^{[1][2]} It was developed by Philips in 1995 for use in commercial projection systems, home theatre projectors, MD-PTVs and video walls. Unlike other common mercury vapor lamps used in projection systems, it is not a metal halide lamp, but uses only mercury. Philips claims a lifetime of over 10,000 hours for the lamps. These lamps are highly efficient compared to other projection lamps – a single 132 watt UHP lamp is used by DLP manufacturers such as Samsung and RCA to power their DLP rear-projection TV lines, however Laser Display technology could be the superseding technology due to its increased longevity and display characteristics.

9.1 Known manufacturers of high pressure discharge lamps (UHP or similar)

- Iwasaki (HSCR)
- Osram/Sylvania (P-VIP)
- Panasonic, Matsushita (HS)
- Philips (UHP)
- Phoenix (SHP)
- Ushio (NSH)
- Panasonic (UHM)

9.2 Devices using UHP lamps

- Samsung DLP rear-projection TV sets.
- Sony LCD rear-projection TV sets.
- Most Digital Projectors Manufactured post 2001 (except LED projectors)

- Olympus ILP-2 High Intensity Light Source
- Mitsubishi DLP Projection Televisions
- Barco Sim7 series LCoS simulation projectors

9.3 References

- Guenther Derra et al. (2005). “UHP lamp systems for projection applications”. *J. Phys. D: Appl. Phys.* **38** (17): 2995–3010. doi:10.1088/0022-3727/38/17/R01.
- Pavel Pekarski et al. (2003). “UHP Lamps for Projection Systems”. *International Conference on Phenomena in Ionized Gases* (Philips Research Laboratories, Weisshausstr.2, D-52066 Aachen, Germany).

9.4 References

- [1] Flesch, Peter (2006). *Light and Light Sources: High-intensity Discharge Lamps*. Springer. p. 39. ISBN 9783540326854.
- [2] Richard, Cadena (2012). *Automated Lighting: The Art and Science of Moving Light in Theatre, Live Performance and Entertainment*. CRC Press. p. 565. ISBN 9781136085253.

9.5 External links

- Philips, UHP lamp manufacturer.
- DLP information site, FixYourDLP.com.
- Texas Instruments' DLP website.
- Where to find original UHP FRONT PROJECTION replacement lamps: Philips Digital Projection Lighting website

- Make sure it's an original! : Philips Digital Projection Lighting official brochure to educate people on the importance of buying and using an ORIGINAL lamp

Chapter 10

Metal-halide lamp



Metal halide lamp bulb (type /O with arc tube shield.)



Metal halide streetlight in Tallinn, Estonia



Metal halide floodlights at a baseball field

Metal-halide lamp should not be confused with Halogen lamp

A **metal-halide lamp** is an electric lamp that produces light by an electric arc through a gaseous mixture of vaporized mercury and metal halides^{[1][2]} (compounds of metals with bromine or iodine). It is a type of high-intensity discharge (HID) gas discharge lamp.^[1] Developed in the 1960s, they are similar to mercury vapor lamps,^[1] but contain additional metal halide compounds in the quartz arc tube, which improve the efficacy and color rendition of the light. The most common metal

halide compound used is sodium iodide. Once the arc tube reaches its running temperature, the sodium dissociates from the iodine, adding orange and reds to the lamp's spectrum from the sodium D line as the metal ionizes. As a result, metal-halide lamps have high luminous efficacy of around 75 - 100 lumens per watt,^[2] which is about twice that of mercury vapor lights^[1] and produce an intense white light. Lamp life is 6,000 to 15,000 hours.^{[2][3]} As one of the most efficient sources of high CRI white light, metal halides as of 2005 were the fastest growing segment of the lighting industry.^[1] They are used for wide area overhead lighting^[2] of commercial, industrial, and public spaces, such as parking lots, sports arenas, factories, and retail stores,^[1] as well as residential security lighting and automotive headlamps (xenon headlights).

The lamps consist of a small fused quartz or ceramic arc tube which contains the gases and the arc, enclosed inside a larger glass bulb which has a coating to filter out the ultraviolet light produced.^{[1][3]} They operate at a pressure between 4 to 20 atms, and require special fixtures to operate safely, as well as an electrical ballast. Metal atoms produce most of the light output.^[1] They require a warm-up period of several minutes to reach full light output.^[2]

10.1 Uses

Metal-halide lamps are used both for general lighting purposes both indoors and outdoors, automotive and specialty applications. Because of their wide spectrum,^[4] they are used for indoor growing applications, in athletic facilities and are quite popular with reef aquarists, who need a high intensity light source for their corals.

Metal-halide lamps are used in automobile headlamps, where they are commonly known as "xenon headlamps" due to the use of xenon gas in the bulb instead of the argon typically used in other halide lamps. They produce a more intense light than incandescent headlamps.

Another widespread use for such lamps is in photographic lighting and stage lighting fixtures, where they are commonly known as MSD lamps and are generally used in 150, 250, 400, 575 and 1,200 watt ratings, especially

intelligent lighting.

10.2 Operation

Like other gas-discharge lamps such as the very-similar mercury-vapor lamps, metal-halide lamps produce light by making an electric arc in a mixture of gases. In a metal-halide lamp, the compact arc tube contains a high-pressure mixture of argon or xenon, mercury, and a variety of metal halides, such as sodium iodide and scandium iodide.^[5] The particular mixture of halides influences the correlated color temperature and intensity (making the light bluer, or redder, for example). The argon gas in the lamp is easily ionized, which facilitates striking the arc across the two electrodes when voltage is first applied to the lamp. The heat generated by the arc then vaporizes the mercury and metal halides, which produce light as the temperature and pressure increases.

Common operating conditions inside the arc tube are 5–50 atm or more^[6] (70–700 psi or 500–5000 kPa) and 1000–3000 °C.^[7] Like all other gas-discharge lamps, metal-halide lamps have negative resistance, and with the rare exception of self-ballasted lamps with a filament, require a ballast to provide proper starting and operating voltages and regulate the current flow in the lamp. About 24% of the energy used by metal-halide lamps produces light (an efficacy of 65–115 lm/W),^[4] making them substantially more efficient than incandescent bulbs, which typically have efficiencies in the range 2–4%.

10.3 Components

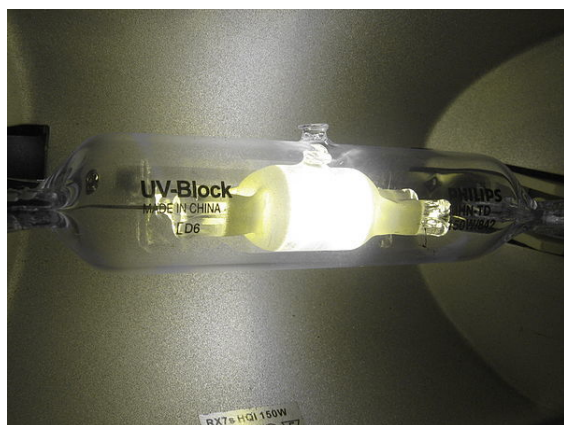

150 watt metal-halide bulb in fixture, about halfway through warmup

Metal-halide lamps consist of an arc tube with electrodes, an outer bulb, and a base.

10.3.1 Arc tube

Inside the fused quartz *arc tube* two tungsten electrodes doped with thorium, are sealed into each end and current is passed to them by molybdenum foil seals in the fused silica. It is within the arc tube that the light is actually created.

Besides the mercury vapor, the lamp contains iodides or sometimes bromides of different metals. Scandium and sodium are used in some types, thallium, indium and sodium in European *Tri-Salt* models, and more recent types use dysprosium for high colour temperature, tin for lower colour temperature. Holmium and thulium are used in some very high power movie lighting models. Gallium or lead is used in special high UV-A models for printing purposes. The mixture of the metals used defines the color of the lamp. Some types for festive or theatrical effect use almost pure iodides of thallium, for green lamps, and indium, for blue lamps. An alkali metal, (sodium or potassium), is almost always added to reduce the arc impedance, allowing the arc tube to be made sufficiently long and simple electrical ballasts to be used. A noble gas, usually argon, is cold filled into the arc tube at a pressure of about 2 kPa to facilitate starting of the discharge. Argon filled lamps are typically quite slow to start up, taking several minutes to reach full light intensity; xenon fill as used in automotive headlamps has a much better start up time.

The ends of the arc tube are often externally coated with white infrared-reflective zirconium silicate or zirconium oxide to reflect heat back onto the electrodes to keep them hot and thermionically emitting. Some bulbs have a phosphor coating on the inner side of the outer bulb to improve the spectrum and diffuse the light.

In the mid-1980s a new type of metal-halide lamp was developed, which, instead of a quartz (fused silica) arc tube as used in mercury vapor lamps and previous metal-halide lamp designs, use a sintered alumina arc tube similar to those used in the high pressure sodium lamp. This development reduces the effects of ion creep that plagues fused silica arc tubes. During their life, sodium and other elements tends to migrate into the quartz tube, because of high UV radiation and gas ionization, resulting in depletion of light emitting material that causes cycling. The sintered alumina arc tube does not allow the ions to creep through, maintaining a more constant colour over the life of the lamp. These are usually referred as ceramic metal-halide lamps or CMH lamps.

The concept of adding metallic iodides for spectral modification (specifically: sodium - yellow, lithium - red, indium - blue, potassium and rubidium - deep red, and thallium - green) of a mercury arc discharge to create the first metal-halide lamp can be traced to patent US1025932 in 1912 by Charles Proteus Steinmetz, the “Wizard of General Electric”.

The amount of mercury used has lessened over years of

progress.

10.3.2 Outer bulb

Most types are fitted with an outer glass bulb to protect the inner components and prevent heat loss. The outer bulb can also be used to block some or all of the UV light generated by the mercury vapor discharge, and can be composed of specially doped “UV stop” fused silica. Ultraviolet protection is commonly employed in single ended (single base) models and double ended models that provide illumination for nearby human use. Some high powered models, particularly the lead-gallium UV printing models and models used for some types of sports stadium lighting do not have an outer bulb. The use of a bare arc tube can allow transmission of UV or precise positioning within the optical system of a luminaire. The cover glass of the luminaire can be used to block the UV, and can also protect people or equipment if the lamp should fail by exploding.

10.3.3 Base

Some types have an **Edison screw** metal base, for various power ratings between 10 to 18,000 watts. Other types are double-ended, as depicted above, with R7s-24 bases composed of ceramic, along with metal connections between the interior of the arc tube and the exterior. These are made of various alloys (such as iron-cobalt-nickel) that have a thermal coefficient of expansion that matches that of the arc tube.

10.3.4 Ballasts

The electric arc in metal-halide lamps, as in all **gas discharge lamps** has a **negative resistance** property; meaning that as the current through the bulb increases, the **voltage** across it decreases. If the bulb is powered from a constant voltage source such as directly from the AC wiring, the current will increase until the bulb destroys itself; therefore, halide bulbs require **electrical ballasts** to limit the arc's current. There are two types:

1. Many fixtures use an inductive ballast similar to those used with **fluorescent lamps**. This consists of an iron-core inductor. The inductor presents an impedance to AC current. If the current through the lamp increases, the inductor reduces the voltage to keep the current limited.
2. Electronic ballasts are lighter and more compact. They consist of an **electronic oscillator** which generates a high frequency current to drive the lamp. Because they have lower resistive losses than an inductive ballast, they are more energy efficient. However, high-frequency operation does not increase lamp efficacy as for **fluorescent lamps**.



Electronic ballast for 35W metal halide light bulbs

Pulse-start metal-halide bulbs don't contain a starting electrode which strikes the arc, and require an ignitor to generate a high-voltage (1–5 kV on cold strike, over 30 kV on hot restrike) pulse to start the arc. Electronic ballasts include the igniter circuit in one package. **American National Standards Institute (ANSI)** lamp-ballast system standards establish parameters for all metal-halide components (with the exception of some newer products).

Self-ballasted lamps

As of 2012 several companies started to offer self-ballasted metal-halide lamps as a direct replacement for incandescent and self-ballasted **mercury-vapor lamps**. These lamps include an arc tube with a starting electrode as well as a tubular **halogen lamp** which is connected in series and used to regulate the current in the arc tube. A resistor provides the current limiting for the starting electrode. Like self-ballasted **mercury-vapor lamps**, self-ballasted metal-halide lamps are connected directly to mains power and do not require an external ballast. In contrast to the former, these lamps usually have a clear outer bulb without a coating, making the arc tube and the

halogen lamp tube clearly visible from the outside.

10.4 Color temperature

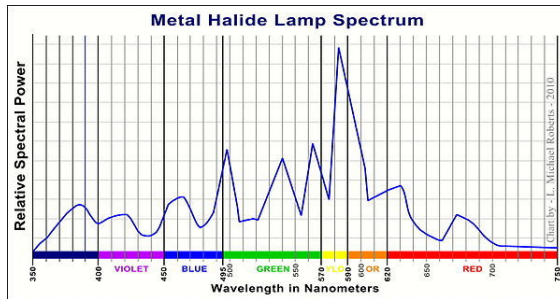

Output spectrum of a typical metal-halide lamp showing peaks at 385nm, 422nm, 497nm, 540nm, 564nm, 583nm (highest), 630nm, and 674nm.

Because of the whiter and more natural light generated, metal-halide lamps were initially preferred to the bluish mercury vapor lamps. With the introduction of specialized metal-halide mixtures, metal-halide lamps are now available with a correlated color temperature from 3,000 K to over 20,000 K. Color temperature can vary slightly from lamp to lamp, and this effect is noticeable in places where many lamps are used. Because the lamp's color characteristics tend to change during lamp's life, color is measured after the bulb has been burned for 100 hours (seasoned) according to ANSI standards. Newer metal-halide technology, referred to as "pulse start," has improved color rendering and a more controlled kelvin variance (± 100 to 200 kelvins).

The color temperature of a metal-halide lamp can also be affected by the electrical characteristics of the electrical system powering the bulb and manufacturing variances in the bulb itself. If a metal-halide bulb is underpowered, because of the lower operating temperature, its light output will be bluish because of the evaporation of mercury alone. This phenomenon can be seen during warmup, when the arc tube has not yet reached full operating temperature and the halides have not fully vaporized. It is also very apparent with dimming ballasts. The inverse is true for an overpowered bulb, but this condition can be hazardous, leading possibly to arc-tube explosion because of overheating and overpressure.

10.5 Starting and warm up

A "cold" (below operating temperature) metal-halide lamp cannot immediately begin producing its full light capacity because the temperature and pressure in the inner arc chamber require time to reach full operating levels. Starting the initial argon arc sometimes takes a few seconds, and the warm up period can be as long as five minutes (depending upon lamp type). During this time the

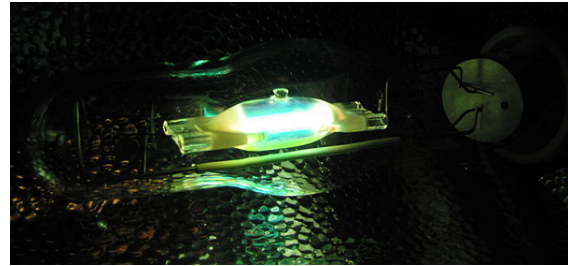

400 W metal-halide lamp shortly after powering up

lamp exhibits different colors as the various metal halides vaporize in the arc chamber.

If power is interrupted, even briefly, the lamp's arc will extinguish, and the high pressure that exists in the hot arc tube will prevent restriking the arc; with a normal ignitor a cool-down period of 5–10 minutes will be required before the lamp can be restarted, but with special ignitors and specially designed lamps, the arc can be immediately re-established. On fixtures without instant re-strike capability, a momentary loss of power can mean no light for several minutes. For safety reasons, many metal-halide fixtures have a backup tungsten-halogen incandescent lamp that operates during cool-down and re-strike. Once the metal halide restrikes and warms up, the incandescent safety light is switched off. A warm lamp also tends to take more time to reach its full brightness than a lamp that is started completely cold.

Most hanging ceiling lamps tend to be passively cooled, with a combined ballast and lamp fixture; immediately restoring power to a hot lamp before it has re-struck can make it take even longer to relight, because of power consumption and heating of the passively cooled lamp ballast that is attempting to relight the lamp.

10.6 End of life behaviour

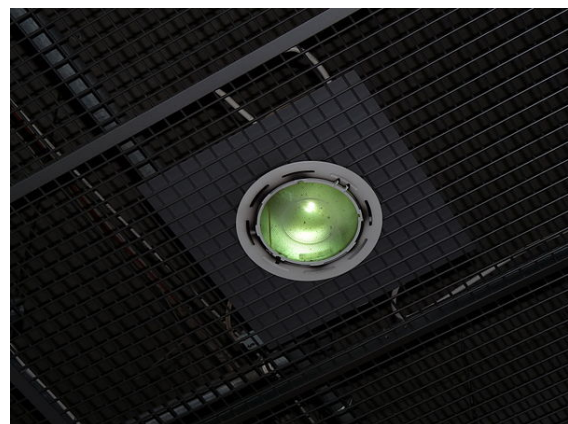

Old HMI lamp

At the end of life, metal-halide lamps exhibit a phenomenon known as *cycling*. These lamps can be started

at a relatively low voltage but as they heat up during operation, the internal gas pressure within the arc tube rises and more and more voltage is required to maintain the arc discharge. As a lamp gets older, the maintaining voltage for the arc eventually rises to exceed the voltage provided by the electrical ballast. As the lamp heats to this point, the arc fails and the lamp goes out. Eventually, with the arc extinguished, the lamp cools down again, the gas pressure in the arc tube is reduced, and the ballast once again causes the arc to strike. This causes the lamp to glow for a while and then goes out, repeatedly. In rare occurrences the lamp explodes at the end of its useful life.^[8]

Modern electronic ballast designs detect cycling and give up attempting to start the lamp after a few cycles. If power is removed and reapplied, the ballast will make a new series of startup attempts.

10.6.1 Risk of lamp explosion

All HID arc tubes deteriorate in strength over their lifetime because of various factors, such as chemical attack, thermal stress and mechanical vibration. As the lamp ages the arc tube becomes discoloured, absorbing light and getting hotter. The tube will continue to become weaker until it eventually fails, causing the breakup of the tube.

Although such failure is associated with end of life, an arc tube can fail at any time even when new, because of unseen manufacturing faults such as microscopic cracks. However, this is quite rare. Manufacturers typically “season” new lamps to check for such defects before the lamps leave the manufacturer’s premises.

Since a metal-halide lamp contains gases at a significant high pressure, failure of the arc tube is inevitably a violent event. Fragments of arc tube are launched, at high velocity, in all directions, striking the outer bulb of the lamp with enough force to cause it to break. If the fixture has no secondary containment (such as a lens, bowl or shield) then the extremely hot pieces of debris will fall down onto people and property below the light, likely resulting in serious injury, damage, and possibly causing a major building fire if flammable material is present.

The risk of a “nonpassive failure” (explosion) of an arc tube is very small. According to information gathered by the National Electrical Manufacturers Association, there are approximately 40 million metal-halide systems in North America alone, and only a very few instances of nonpassive failures have occurred. Although it is impossible to predict or eliminate the risk of a metal-halide lamp exploding, there are several precautions that can reduce the risk:

- Using only well designed lamps from reputable manufacturers and avoiding lamps of unknown origin.
- Inspecting lamps before installing to check for any

faults such as cracks in the tube or outer bulb.

- Replacing lamps before they reach their end of life (i.e. when they have been burning for the number of hours that the manufacturer has stated as the lamp’s rated life).
- For continuously operating lamps, allowing a 15-minute shutdown for every seven days of continuous operation.
- Relamping fixtures as a group. Spot relamping is not recommended.

Also, there are measures that can be taken to reduce the damage caused by a lamp failure violently:

- Ensuring that the fixture includes a piece of strengthened glass or polymeric materials between the lamp and the area it is illuminating. This can be incorporated into the bowl or lens assembly of the fixture.
- Using lamps that have a reinforced glass shield around the arc tube to absorb the impact of flying arc tube debris, preventing it from shattering the outer bulb. Such lamps are safe to use in ‘open’ fixtures. These lamps carry an “O” designation on the packaging reflective of American National Standards Institute (ANSI) standards.

Lamps that require an enclosed fixture are rated “/E”. Lamps that do not require an enclosed fixture are rated “/O” (for open). Sockets for “/O” rated fixtures are deeper. “/E” rated bulbs flare at the base, preventing them from fully screwing into a “/O” socket. “/O” bulbs are narrow at the base allowing them to fully screw in. “/O” bulbs will also fit in an “/E” fixture.

10.7 Other safety concerns

10.7.1 Eyes

Broken and unshielded high-intensity metal-halide bulbs are known to cause eye^[9] and skin injuries, particularly in school gymnasiums.^[10]

10.8 ANSI ballast codes

10.9 See also

- High-intensity discharge lamp (HID)
- Arc lamp
- Sodium-vapor lamp

- Mercury-vapor lamp
- Sulfur lamp
- Neon lamp
- List of light sources
- History of street lighting in the United States

10.10 References

- Waymouth, John (1971). *Electric Discharge Lamps*. Cambridge, MA: The M.I.T. Press. ISBN 0-262-23048-8.
- [1] Hordeski, Michael F. (2005). produce an intense white light. s%20discharge%20mercury&f=false *Dictionary of energy efficiency technologies*. USA: CRC Press. pp. 175–176. ISBN 0-8247-4810-7.
 - [2] Grondzik, Walter T.; Alison G. Kwok; Benjamin Stein; John S. Reynolds (2009). *Mechanical and Electrical Equipment for Buildings, 11th Ed*. USA: John Wiley & Sons. pp. 555–556 and produce an intense white light. ISBN 0-470-57778-9.
 - [3] *Light Right: A practising engineer's manual on energy-efficient lighting*. TERE Press. 2004. pp. 19–20. ISBN 81-7993-044-0.
 - [4] “Metal Halide”. *Venture Lighting*. Retrieved 2012-12-14.
 - [5] Flesch, Peter (2006). *Light and light sources: high-intensity discharge lamps*. Springer. pp. 45–46. ISBN 3-540-32684-7.
 - [6] US patent 4171498, Dietrich Fromm et al., “High pressure electric discharge lamp containing metal halides”, issued 1979-10-16
 - [7] US patent 3234421, Gilbert H. Reiling, “Metallic halide electric discharge lamps”, issued 1966-02-08
 - [8] High Intensity Discharge Lamps (NASA)
 - [9] [url=<http://archpedi.ama-assn.org/cgi/content/full/158/4/372>] Photokeratitis and UV-Radiation Burns Associated With Damaged Metal Halide Lamps]
 - [10] [url=<http://www.fda.gov/Radiation-EmittingProducts/RadiationSafety/AlertsandNotices/ucm116540.htm>] Ultraviolet Radiation Burns from High Intensity Metal Halide and Mercury Vapor Lighting Remain a Public Health Concern]

10.11 Further reading

- Raymond Kane, Heinz Sell *Revolution in lamps: a chronicle of 50 years of progress (2nd ed.)*, The Fairmont Press, Inc. 2001 ISBN 0-88173-378-4

Chapter 11

Gas-discharge lamp

See also: Gas-filled tube

Gas-discharge lamps are a family of artificial light



Germicidal lamps are simple low-pressure mercury vapor discharges in a fused quartz envelope.

sources that generate light by sending an electrical discharge through an ionized gas, a plasma. The character of the gas discharge depends on the pressure of the gas as well as the frequency of the current. Typically, such

lamps use a noble gas (argon, neon, krypton, and xenon) or a mixture of these gases. Most lamps are filled with additional materials, like mercury, sodium, and metal halides. In operation the gas is ionized, and free electrons, accelerated by the electrical field in the tube, collide with gas and metal atoms. Some electrons in the atomic orbitals of these atoms are excited by these collisions to a higher energy state. When the excited atom falls back to a lower energy state, it emits a photon of a characteristic energy, resulting in infrared, visible light, or ultraviolet radiation. Some lamps convert the ultraviolet radiation to visible light with a fluorescent coating on the inside of the lamp's glass surface. The fluorescent lamp is perhaps the best known gas-discharge lamp.

Compared to incandescent lamps, gas-discharge lamps offer higher efficiency,^{[1][2]} but are more complicated to manufacture and require auxiliary electronic equipment such as ballasts to control current flow through the gas. Some gas-discharge lamps also have a perceivable start-up time to achieve their full light output. Still, due to their greater efficiency, gas-discharge lamps are replacing incandescent lights in many lighting applications.

11.1 History

The history of gas-discharge lamps began in 1675 when French astronomer Jean-Felix Picard observed that the empty space in his mercury barometer glowed as the mercury jiggled while he was carrying the barometer.^[3] Investigators, including Francis Hauksbee, tried to determine the cause of the phenomenon. Hauksbee first demonstrated a gas-discharge lamp in 1705. He showed that an evacuated or partially evacuated glass globe, in which he placed a small amount of mercury, while charged by static electricity could produce a light bright enough to read by. The phenomenon of electric arc was first described by Vasily V. Petrov, a Russian scientist, in 1802; Sir Humphry Davy demonstrated in the same year the electric arc at the Royal Institution of Great Britain. Since then, discharge light sources have been researched because they create light from electricity considerably more efficiently than incandescent light bulbs.

The father of the low-pressure gas discharge tube was German glassblower **Heinrich Geissler**, who beginning in 1857 constructed colorful artistic **cold cathode** tubes with different gases in them which glowed with many different colors, called **Geissler tubes**. It was found that inert gases like the **noble gases** neon, argon, krypton or xenon, as well as **carbon dioxide** worked well in tubes. This technology was commercialized by French engineer **Georges Claude** in 1910 and became **neon lighting**, used in neon signs.

The introduction of the metal vapor lamp, including various metals within the discharge tube, was a later advance. The heat of the gas discharge vaporized some of the metal and the discharge is then produced almost exclusively by the metal vapor. The usual metals are **sodium** and **mercury** owing to their visible spectrum emission.

One hundred years of research later led to lamps without electrodes which are instead energized by microwave or radio frequency sources. In addition, light sources of much lower output have been created, extending the applications of discharge lighting to home or indoor use.

11.2 Color

Each gas, depending on its atomic structure emits certain wavelengths which translates in different colors of the lamp. As a way of evaluating the ability of a light source to reproduce the colors of various objects being lit by the source, the **International Commission on Illumination (CIE)** introduced the **color rendering index (CRI)**. Some gas-discharge lamps have a relatively low CRI, which means colors they illuminate appear substantially different from how they do under sunlight or other high-CRI illumination.

11.3 Types

Lamps are divided into families based on the pressure of gas in the bulb, below. A second distinction used is whether the cathode is heated:

- **Hot-cathode lamps** have electrodes which operate at a high temperature, which during operation are heated by the arc current in the lamp. The heat knocks electrons out of the electrodes by **thermionic emission**, which helps maintain the arc. In many types the electrodes consist of **electrical filaments** made of fine wire, which are heated by a separate current at startup, to get the arc started.
- **Cold-cathode lamps** have electrodes which operate at room temperature. To start conduction in the lamp a high enough voltage (the **striking voltage**) must be applied to ionize the gas, so these lamps require higher voltage to start.



A compact fluorescent lamp

11.3.1 Low pressure discharge lamps

Low-pressure lamps have working pressure much less than atmospheric pressure. For example common fluorescent lamps operate at a pressure of about 0.3% of atmospheric pressure.

- **Fluorescent lamps**, a heated-cathode lamp, the most common lamp in office lighting and many other applications, produces up to 100 lumens per watt
- **Neon lighting**, a widely used form of cold-cathode specialty lighting consisting of long tubes filled with various gases at low pressure excited by high voltages, used as advertising in **neon signs**.
- **Low pressure sodium lamps**, the most efficient gas-discharge lamp type, producing up to 200 lumens per watt, but at the expense of very poor color rendering. The almost monochromatic yellow light is only acceptable for street lighting and similar applications.
- A small discharge lamp containing a **bi-metallic switch** is used to start a fluorescent lamp. In this case the heat of the discharge is used to actuate the switch; the starter is contained in an opaque enclosure and the small light output is not used.



Gas-discharge lamp "Candle".

- Continuous glow lamps are produced for special applications where the electrodes may be cut in the shape of alphanumeric characters and figural shapes.^[4]
- A flicker light bulb, flicker flame light bulb or flicker glow lamp is a gas-discharge lamp which produces light by ionizing a gas, usually neon mixed with helium and a small amount of nitrogen gas, by an electric current passing through two flame shaped electrode screens coated with partially decomposed barium azide. The ionized gas moves randomly between the two electrodes which produces a flickering effect, often marketed as suggestive of a candle flame (see image). US patent 3238408, Kayatt Philip J., "Flicker glow lamps", issued 1966-03-1

11.3.2 High pressure discharge lamps

High-pressure lamps have a discharge that takes place in gas under slightly less to greater than atmospheric pressure. For example, a high pressure sodium lamp has an arc tube under 100 to 200 torr pressure, about 14% to 28% of atmospheric pressure; some automotive HID headlamps have up to 50 bar or fifty times atmospheric pressure.

- Metal halide lamps. These lamps produce almost white light, and attain 100 lumen per watt light output. Applications include indoor lighting of high buildings, parking lots, shops, sport terrains.
- High pressure sodium lamps, producing up to 150 lumens per watt. These lamps produce a broader

light spectrum than the low pressure sodium lamps. Also used for street lighting, and for artificial photoassimilation for growing plants

- High pressure mercury-vapor lamps. This lamp type is the oldest high pressure lamp type, being replaced in most applications by the metal halide lamp and the high pressure sodium lamp. It requires a shorter arc length.

11.3.3 High-intensity discharge lamps

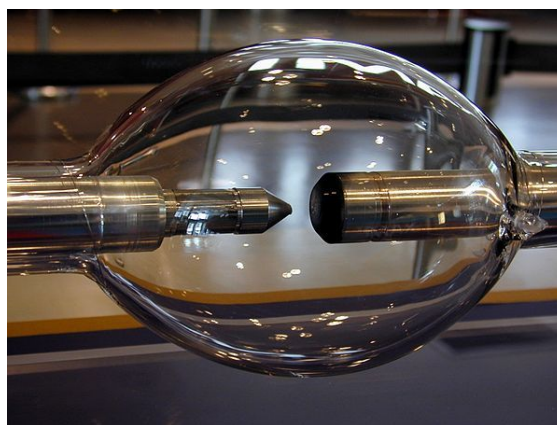

15 kW xenon short-arc lamp used in IMAX projectors

Main article: High-intensity discharge lamp

A high-intensity discharge (HID) lamp is a type of electrical lamp which produces light by means of an electric arc between tungsten electrodes housed inside a translucent or transparent fused quartz or fused alumina arc tube. Compared to other lamp types, relatively high arc power exists for the arc length. Examples of HID lamps include:

- Mercury-vapor lamps
- Metal halide lamps
- Ceramic discharge metal halide lamps
- Sodium vapor lamps
- Xenon arc lamps

HID lamps are typically used when high levels of light and energy efficiency are desired.

11.4 Other examples

Main article: Xenon flash lamp

The **Xenon flash lamp** produces a single flash of light in the millisecond-microsecond range and is commonly used in film, photography and theatrical lighting. Particularly robust versions of this lamp, known as **strobe lights**, can produce long sequences of flashes, allowing for the **stroboscopic examination of motion**. This has found use in the study of mechanical motion, in medicine and in the lighting of dance halls.

11.5 See also

- Electric arc
- Electric glow discharge
- Emission spectrum
- Fluorescent lamp
- Gas-filled tube
- Hydrargyrum medium-arc iodide lamp
- List of light sources
- Over-illumination

11.6 References

- [1] “Types of Lighting”. *Energy.gov*. US Department of Energy. Retrieved 10 June 2013.
- [2] “LIGHTING TECHNOLOGIES: A GUIDE TO ENERGY-EFFICIENT ILLUMINATION” (PDF). *Energy Star*. US Environmental Protection Agency. Retrieved 10 June 2013.
- [3] See Wikipedia’s article: Barometric light.
- [4] http://bulbcollector.com/gateway/Gas_Discharge_Lamps/Neon

11.7 Further reading

- Waymouth, John (1971). *Electric Discharge Lamps*. Cambridge, MA: The M.I.T. Press. ISBN 0-262-23048-8.
- National Highway Traffic Safety Administration. “Glare from headlamps and other front mounted lamps”. *Federal Motor Vehicle Safety Standard No. 108*. US Department of Transportation. Retrieved 2006-01-23.

11.8 External links

- Lamps and Indicators at DMOZ

Chapter 12

Fluorescent lamp

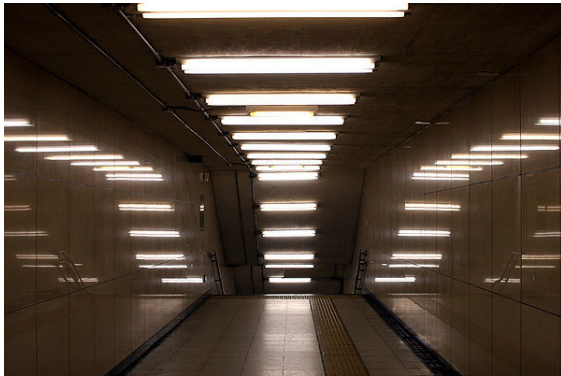

Fluorescent lamps



Typical F71T12 100 W bi-pin lamp used in tanning beds. The (Hg) symbol indicates that this lamp contains mercury. In the US, this symbol is now required on all fluorescent lamps that contain mercury.^[1]



Top, two compact fluorescent lamps. Bottom, two fluorescent tube lamps. A matchstick, left, is shown for scale.



Compact fluorescent lamp with electronic ballast



One style of lamp holder for T12 and T8 bi pin fluorescent lamps

A **fluorescent lamp** or a **fluorescent tube** is a low



Inside the lamp end of a preheat bi-pin lamp. In this lamp the filament is surrounded by an oblong metal cathode shield, which helps reduce lamp end darkening.^[2]

pressure mercury-vapor gas-discharge lamp that uses fluorescence to produce visible light. An electric current in the gas excites mercury vapor which produces short-wave ultraviolet light that then causes a phosphor coating on the inside of the bulb to glow. A fluorescent lamp converts electrical energy into useful light much more efficiently than incandescent lamps. The luminous efficacy of a fluorescent light bulb can exceed 100 lumens per watt, several times the efficacy of an incandescent bulb with comparable light output.

Fluorescent lamp fixtures are more costly than incandescent lamps because they require a ballast to regulate the current through the lamp, but the lower energy cost typically offsets the higher initial cost. Compact fluorescent lamps are now available in the same popular sizes as incandescents and are used as an energy-saving alternative in homes.

Because they contain mercury, many fluorescent lamps are classified as hazardous waste. The United States Environmental Protection Agency recommends that fluorescent lamps be segregated from general waste for recycling or safe disposal.^[3]

12.1 History

12.1.1 Physical discoveries

Fluorescence of certain rocks and other substances had been observed for hundreds of years before its nature was understood. By the middle of the 19th century, experimenters had observed a radiant glow emanating from partially evacuated glass vessels through which an electric current passed. One of the first to explain it was the Irish scientist Sir George Stokes from the University of Cam-

bridge, who named the phenomenon “fluorescence” after fluorite, a mineral many of whose samples glow strongly due to impurities. The explanation relied on the nature of electricity and light phenomena as developed by the British scientists Michael Faraday in the 1840s and James Clerk Maxwell in the 1860s.^[4]

Little more was done with this phenomenon until 1856 when a German glassblower named Heinrich Geissler created a mercury vacuum pump that evacuated a glass tube to an extent not previously possible. When an electrical current passed through a Geissler tube, a strong green glow on the walls of the tube at the cathode end could be observed. Because it produced some beautiful light effects, the Geissler tube was a popular source of amusement. More important, however, was its contribution to scientific research. One of the first scientists to experiment with a Geissler tube was Julius Plücker who systematically described in 1858 the luminescent effects that occurred in a Geissler tube. He also made the important observation that the glow in the tube shifted position when in proximity to an electromagnetic field. Alexandre Edmond Becquerel observed in 1859 that certain substances gave off light when they were placed in a Geissler tube. He went on to apply thin coatings of luminescent materials to the surfaces of these tubes. Fluorescence occurred, but the tubes were very inefficient and had a short operating life.^[5]

Inquiries that began with the Geissler tube continued as even better vacuums were produced. The most famous was the evacuated tube used for scientific research by William Crookes. That tube was evacuated by the highly effective mercury vacuum pump created by Hermann Sprengel. Research conducted by Crookes and others ultimately led to the discovery of the electron in 1897 by J. J. Thomson and X-rays in 1895 by Wilhelm Roentgen. But the Crookes tube, as it came to be known, produced little light because the vacuum in it was too good and thus lacked the trace amounts of gas that are needed for electrically stimulated luminescence.

12.1.2 Early discharge lamps

While Becquerel was interested primarily in conducting scientific research into fluorescence, Thomas Edison briefly pursued fluorescent lighting for its commercial potential. He invented a fluorescent lamp in 1896 that used a coating of calcium tungstate as the fluorescing substance, excited by X-rays, but although it received a patent in 1907,^[6] it was not put into production. As with a few other attempts to use Geissler tubes for illumination, it had a short operating life, and given the success of the incandescent light, Edison had little reason to pursue an alternative means of electrical illumination. Nikola Tesla made similar experiments in the 1890s, devising high-frequency powered fluorescent bulbs that gave a bright greenish light, but as with Edison’s devices, no commercial success was achieved.

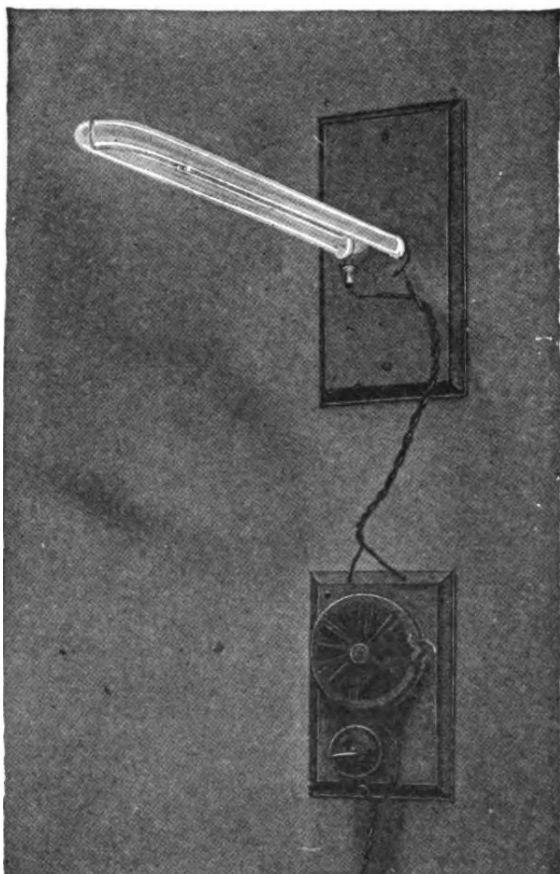

One of the first mercury vapor lamps invented by Peter Cooper Hewitt, 1903. It was similar to a fluorescent lamp without the fluorescent coating on the tube, and produced greenish light. The round device under the lamp is the ballast.

Although Edison lost interest in fluorescent lighting, one of his former employees was able to create a gas-based lamp that achieved a measure of commercial success. In 1895 Daniel McFarlan Moore demonstrated lamps 2 to 3 meters (6.6 to 9.8 ft) in length that used carbon dioxide or nitrogen to emit white or pink light, respectively. As with future fluorescent lamps, they were considerably more complicated than an incandescent bulb.^[7]

After years of work, Moore was able to extend the operating life of the lamps by inventing an electromagnetically controlled valve that maintained a constant gas pressure within the tube.^[8] Although Moore's lamp was complicated, was expensive to install, and required very high voltages, it was considerably more efficient than incandescent lamps, and it produced a closer approximation to natural daylight than contemporary incandescent lamps. From 1904 onwards Moore's lighting system was installed in a number of stores and offices.^[9] Its success contributed to General Electric's motivation to improve the incandescent lamp, especially its filament. GE's efforts came to fruition with the invention of a tungsten-based filament. The extended lifespan and improved efficacy of incandescent bulbs negated one of the key advantages of Moore's lamp, but GE purchased the rele-



Peter Cooper Hewitt

vant patents in 1912. These patents and the inventive efforts that supported them were to be of considerable value when the firm took up fluorescent lighting more than two decades later.

At about the same time that Moore was developing his lighting system, another American was creating a means of illumination that also can be seen as a precursor to the modern fluorescent lamp. This was the mercury-vapor lamp, invented by Peter Cooper Hewitt and patented in 1901 (US 682692; this patent number is frequently misquoted as US 889,692). Hewitt's lamp glowed when an electric current was passed through mercury vapor at a low pressure. Unlike Moore's lamps, Hewitt's were manufactured in standardized sizes and operated at low voltages. The mercury-vapor lamp was superior to the incandescent lamps of the time in terms of energy efficiency, but the blue-green light it produced limited its applications. It was, however, used for photography and some industrial processes.

Mercury vapor lamps continued to be developed at a slow pace, especially in Europe, and by the early 1930s they received limited use for large-scale illumination. Some of them employed fluorescent coatings, but these were used primarily for color correction and not for enhanced light output. Mercury vapor lamps also anticipated the fluorescent lamp in their incorporation of a ballast to maintain a constant current.

Cooper-Hewitt had not been the first to use mercury vapor for illumination, as earlier efforts had been mounted by Way, Rapieff, Arons, and Bastian and Salisbury. Of particular importance was the mercury vapor lamp in-

vented by Küch in Germany. This lamp used quartz in place of glass to allow higher operating temperatures, and hence greater efficiency. Although its light output relative to electrical consumption was better than that of other sources of light, the light it produced was similar to that of the Cooper-Hewitt lamp in that it lacked the red portion of the spectrum, making it unsuitable for ordinary lighting.

12.1.3 Neon lamps

Main article: [Neon lighting](#)

The next step in gas-based lighting took advantage of the luminescent qualities of neon, an inert gas that had been discovered in 1898 by isolation from the atmosphere. Neon glowed a brilliant red when used in Geissler tubes.^[10] By 1910, Georges Claude, a Frenchman who had developed a technology and a successful business for air liquefaction, was obtaining enough neon as a byproduct to support a neon lighting industry.^{[11][12]} While neon lighting was used around 1930 in France for general illumination, it was no more energy-efficient than conventional incandescent lighting. Neon tube lighting, which also includes the use of argon and mercury vapor as alternate gases, came to be used primarily for eye-catching signs and advertisements. Neon lighting was relevant to the development of fluorescent lighting, however, as Claude's improved electrode (patented in 1915) overcame "sputtering", a major source of electrode degradation. Sputtering occurred when ionized particles struck an electrode and tore off bits of metal. Although Claude's invention required electrodes with a lot of surface area, it showed that a major impediment to gas-based lighting could be overcome.

The development of the neon light also was significant for the last key element of the fluorescent lamp, its fluorescent coating. In 1926 Jacques Risler received a French patent for the application of fluorescent coatings to neon light tubes.^[9] The main use of these lamps, which can be considered the first commercially successful fluorescents, was for advertising, not general illumination. This, however, was not the first use of fluorescent coatings; Edison used calcium tungstate for his unsuccessful lamp. Other efforts had been mounted, but all were plagued by low efficiency and various technical problems. Of particular importance was the invention in 1927 of a low-voltage "metal vapor lamp" by Friedrich Meyer, Hans-Joachim Spanner, and Edmund Germer, who were employees of a German firm in Berlin. A German patent was granted but the lamp never went into commercial production.

12.1.4 Commercialization of fluorescent lamps

All the major features of fluorescent lighting were in place at the end of the 1920s. Decades of invention and development had provided the key components of fluorescent lamps: economically manufactured glass tubing, inert gases for filling the tubes, electrical ballasts, long-lasting electrodes, mercury vapor as a source of luminescence, effective means of producing a reliable electrical discharge, and fluorescent coatings that could be energized by ultraviolet light. At this point, intensive development was more important than basic research.

In 1934, Arthur Compton, a renowned physicist and GE consultant, reported to the GE lamp department on successful experiments with fluorescent lighting at General Electric Co., Ltd. in Great Britain (unrelated to General Electric in the United States). Stimulated by this report, and with all of the key elements available, a team led by George E. Inman built a prototype fluorescent lamp in 1934 at General Electric's Nela Park (Ohio) engineering laboratory. This was not a trivial exercise; as noted by Arthur A. Bright, "A great deal of experimentation had to be done on lamp sizes and shapes, cathode construction, gas pressures of both argon and mercury vapor, colors of fluorescent powders, methods of attaching them to the inside of the tube, and other details of the lamp and its auxiliaries before the new device was ready for the public."^[9]

In addition to having engineers and technicians along with facilities for R&D work on fluorescent lamps, General Electric controlled what it regarded as the key patents covering fluorescent lighting, including the patents originally issued to Hewitt, Moore, and Küch. More important than these was a patent covering an electrode that did not disintegrate at the gas pressures that ultimately were employed in fluorescent lamps. Albert W. Hull of GE's Schenectady Research Laboratory filed for a patent on this invention in 1927, which was issued in 1931.^[13] General Electric used its control of the patents to prevent competition with its incandescent lights and probably delayed the introduction of fluorescent lighting by 20 years. Eventually, war production required 24-hour factories with economical lighting and fluorescent lights became available.

While the Hull patent gave GE a basis for claiming legal rights over the fluorescent lamp, a few months after the lamp went into production the firm learned of a U.S. patent application that had been filed in 1927 for the aforementioned "metal vapor lamp" invented in Germany by Meyer, Spanner, and Germer. The patent application indicated that the lamp had been created as a superior means of producing ultraviolet light, but the application also contained a few statements referring to fluorescent illumination. Efforts to obtain a U.S. patent had met with numerous delays, but were it to be granted, the patent might have caused serious difficulties for GE. At first,

GE sought to block the issuance of a patent by claiming that priority should go to one of their employees, Leroy J. Buttolph, who according to their claim had invented a fluorescent lamp in 1919 and whose patent application was still pending. GE also had filed a patent application in 1936 in Inman's name to cover the "improvements" wrought by his group. In 1939 GE decided that the claim of Meyer, Spanner, and Germer had some merit, and that in any event a long interference procedure was not in their best interest. They therefore dropped the Buttolph claim and paid \$180,000 to acquire the Meyer, et al. application, which at that point was owned by a firm known as Electrons, Inc. The patent was duly awarded in December 1939.^[14] This patent, along with the Hull patent, put GE on what seemed to be firm legal ground, although it faced years of legal challenges from *Sylvania Electric Products, Inc.*, which claimed *infringement* on patents that it held.

Even though the patent issue would not be completely resolved for many years, General Electric's strength in manufacturing and marketing the bulb gave it a pre-eminent position in the emerging fluorescent light market. Sales of "fluorescent lumiline lamps" commenced in 1938 when four different sizes of tubes were put on the market used in fixtures manufactured by three leading corporations, *Lightolier*, *Artcraft Fluorescent Lighting Corporation*, and *Globe Lighting*, two based in New York City. During the following year GE and *Westinghouse* publicized the new lights through exhibitions at the *New York World's Fair* and the *Golden Gate International Exposition* in San Francisco. Fluorescent lighting systems spread rapidly during World War II as wartime manufacturing intensified lighting demand. By 1951 more light was produced in the United States by fluorescent lamps than by incandescent lamps.^[15]

In the first years zinc orthosilicate with varying content of beryllium was used as greenish phosphor. Small additions of magnesium tungstate improved the blue part of the spectrum yielding acceptable white. After it was discovered that beryllium was toxic, halophosphate based phosphors took over.^[16]

12.2 Principles of operation

The fundamental means for conversion of electrical energy into radiant energy in a fluorescent lamp relies on *inelastic scattering* of electrons when an incident electron collides with an atom in the gas. If the (incident) free electron has enough *kinetic energy*, it transfers energy to the atom's outer electron, causing that electron to temporarily jump up to a higher *energy level*. The collision is 'inelastic' because a loss of kinetic energy occurs.

This higher energy state is unstable, and the atom will emit an *ultraviolet photon* as the atom's electron reverts to a lower, more stable, energy level. Most of the photons that are released from the mercury atoms have

wavelengths in the *ultraviolet (UV)* region of the spectrum, predominantly at wavelengths of 253.7 and 185 *nanometers (nm)*. These are not visible to the human eye, so they must be converted into visible light. This is done by making use of *fluorescence*. Ultraviolet photons are absorbed by electrons in the atoms of the lamp's interior fluorescent coating, causing a similar energy jump, then drop, with emission of a further photon. The photon that is emitted from this second interaction has a lower energy than the one that caused it. The chemicals that make up the phosphor are chosen so that these emitted photons are at wavelengths visible to the human eye. The difference in energy between the absorbed ultra-violet photon and the emitted visible light photon goes toward heating up the phosphor coating.

When the light is turned on, the electric power heats up the cathode enough for it to emit electrons (*thermionic emission*). These electrons collide with and ionize *noble gas* atoms inside the bulb surrounding the filament to form a *plasma* by the process of *impact ionization*. As a result of *avalanche ionization*, the conductivity of the ionized gas rapidly rises, allowing higher currents to flow through the lamp.

The fill gas helps determine the operating electrical characteristics of the lamp, but does not give off light itself. The fill gas effectively increases the distance that electrons travel through the tube, which allows an electron a greater chance of interacting with a mercury atom. Argon atoms, excited to a metastable state by impact of an electron, can impart this energy to a neutral mercury atom and ionize it, described as the *Penning effect*. This has the benefit of lowering the breakdown and operating voltage of the lamp, compared to other possible fill gases such as krypton.^[17]

12.2.1 Construction

A fluorescent lamp tube is filled with a gas containing low pressure mercury vapor and argon, xenon, neon, or krypton. The pressure inside the lamp is around 0.3% of atmospheric pressure.^[18] The inner surface of the lamp is coated with a fluorescent (and often slightly phosphorescent) coating made of varying blends of metallic and *rare-earth phosphor salts*. The lamp's electrodes are typically made of coiled *tungsten* and usually referred to as cathodes because of their prime function of emitting electrons. For this, they are coated with a mixture of barium, strontium and calcium oxides chosen to have a low *thermionic emission* temperature.

Fluorescent lamp tubes are typically straight and range in length from about 100 millimeters (3.9 in) for miniature lamps, to 2.43 meters (8.0 ft) for high-output lamps. Some lamps have the tube bent into a circle, used for table lamps or other places where a more compact light source is desired. Larger U-shaped lamps are used to provide the same amount of light in a more compact area, and are



Close-up of the cathodes of a germicidal lamp (an essentially similar design that uses no fluorescent phosphor, allowing the electrodes to be seen.)

used for special architectural purposes. Compact fluorescent lamps have several small-diameter tubes joined in a bundle of two, four, or six, or a small diameter tube coiled into a helix, to provide a high amount of light output in little volume.

Light-emitting phosphors are applied as a paint-like coating to the inside of the tube. The organic solvents are allowed to evaporate, then the tube is heated to nearly the melting point of glass to drive off remaining organic compounds and fuse the coating to the lamp tube. Careful control of the grain size of the suspended phosphors is necessary; large grains, 35 micrometers or larger, lead to weak grainy coatings, whereas too many small particles 1 or 2 micrometers or smaller leads to poor light maintenance and efficiency. Most phosphors perform best with a particle size around 10 micrometers. The coating must be thick enough to capture all the ultraviolet light produced by the mercury arc, but not so thick that the phosphor coating absorbs too much visible light. The first phosphors were synthetic versions of naturally occurring fluorescent minerals, with small amounts of metals added as activators. Later other compounds were discovered, allowing differing colors of lamps to be made.^[19]

12.2.2 Electrical aspects of operation

Fluorescent lamps are negative differential resistance devices, so as more current flows through them, the electrical resistance of the fluorescent lamp drops, allowing



The unfiltered ultraviolet glow of a germicidal lamp is produced by a low pressure mercury vapor discharge (identical to that in a fluorescent lamp) in an uncoated fused quartz envelope.

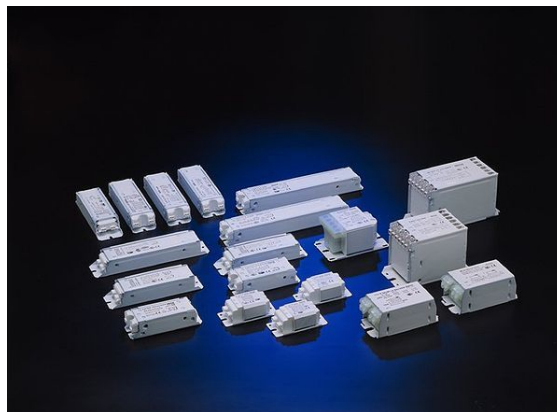

Different ballasts for fluorescent and discharge lamps

for even more current to flow. Connected directly to a constant-voltage power supply, a fluorescent lamp would rapidly self-destruct due to the uncontrolled current flow.

To prevent this, fluorescent lamps must use an auxiliary device, a **ballast**, to regulate the current flow through the lamp.

The terminal voltage across an operating lamp varies depending on the arc current, tube diameter, temperature, and fill gas. A fixed part of the voltage drop is due to the electrodes. A general lighting service 48-inch (1,219 mm) T12^[20] lamp operates at 430 mA, with 100 volts drop. High output lamps operate at 800 mA, and some types operate up to 1.5 A. The power level varies from 33 to 82 watts per meter of tube length (10 to 25 W/ft) for T12 lamps.^[21]

The simplest ballast for alternating current (AC) use is an inductor placed in series, consisting of a winding on a laminated magnetic core. The inductance of this winding limits the flow of AC current. This type is still used, for example, in 120 volt operated desk lamps using relatively short lamps. Ballasts are rated for the size of lamp and power frequency. Where the AC voltage is insufficient to start long fluorescent lamps, the ballast is often a step-up autotransformer with substantial leakage inductance (so as to limit the current flow). Either form of inductive ballast may also include a capacitor for power factor correction.



230 V ballast for 18–20 W

Many different circuits have been used to operate fluorescent lamps. The choice of circuit is based on AC voltage, tube length, initial cost, long term cost, instant versus non-instant starting, temperature ranges and parts availability, etc.

Fluorescent lamps can run directly from a **direct current** (DC) supply of sufficient voltage to strike an arc. The ballast must be resistive, and would consume about as much power as the lamp. When operated from DC, the starting switch is often arranged to reverse the polarity of the supply to the lamp each time it is started; otherwise, the mercury accumulates at one end of the tube. Fluorescent lamps are (almost) never operated directly from DC for those reasons. Instead, an inverter converts the DC into AC and provides the current-limiting function as described below for electronic ballasts.

12.2.3 Effect of temperature

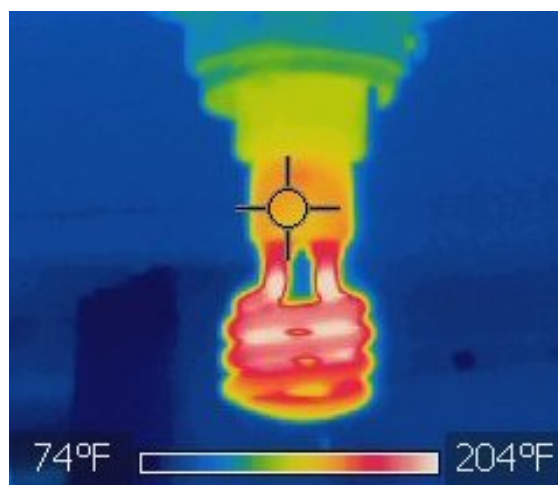

Thermal image of a helical fluorescent lamp.

The light output and performance of fluorescent lamps is critically affected by the temperature of the bulb wall and its effect on the partial pressure of mercury vapor within the lamp.^[19] Each lamp contains a small amount of mercury, which must vaporize to support the lamp current and generate light. At low temperatures the mercury is in the form of dispersed liquid droplets. As the lamp warms, more of the mercury is in vapor form. At higher temperatures, self-absorption in the vapor reduces the yield of UV and visible light. Since mercury condenses at the coolest spot in the lamp, careful design is required to maintain that spot at the optimum temperature, around 40 °C (104 °F).

By using an **amalgam** with some other metal, the vapor pressure is reduced and the optimum temperature range extended upward; however, the bulb wall “cold spot” temperature must still be controlled to prevent migration of the mercury out of the amalgam and condensing on the cold spot. Fluorescent lamps intended for higher output will have structural features such as a deformed tube or internal heat-sinks to control cold spot temperature and mercury distribution. Heavily loaded small lamps, such as compact fluorescent lamps, also include heat-sink areas in the tube to maintain mercury vapor pressure at the optimum value.^[22]

12.2.4 Losses

Only a fraction of the electrical energy input into a lamp is converted to useful light. The ballast dissipates some heat; electronic ballasts may be around 90% efficient. A fixed voltage drop occurs at the electrodes, which also produces heat. Some of the energy in the mercury vapor column is also dissipated, but about 85% is turned into visible and ultraviolet light.

The UV light is absorbed by the lamp’s fluorescent coat-

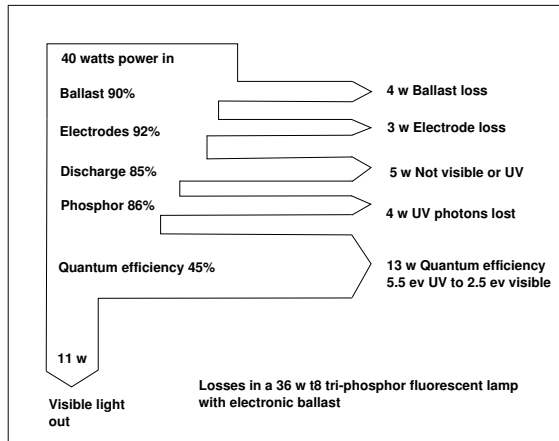

A Sankey diagram of energy losses in a fluorescent lamp. In modern designs, the biggest loss is the quantum efficiency of converting high-energy UV photons to lower-energy visible light photons.

ing, which re-radiates the energy at longer wavelengths to emit visible light. Not all the UV energy striking the phosphor gets converted into visible light. In a modern lamp, for every 100 incident photons of UV impacting the phosphor, only 86 visible light photons are emitted (a quantum efficiency of 86%). The largest single loss in modern lamps is due to the lower energy of each photon of visible light, compared to the energy of the UV photons that generated them (a phenomenon called Stokes shift). Incident photons have an energy of 5.5 electron volts but produce visible light photons with energy around 2.5 electron volts, so only 45% of the UV energy is used; the rest is dissipated as heat. If a so-called “two-photon” phosphor could be developed, this would improve the efficiency but much research has not yet found such a system.^[23]

12.2.5 Cold cathode lamps

Most fluorescent lamps use electrodes that operate by thermionic emission, meaning they are operated at a high enough temperature for the electrode material (usually aided by a special coating) to emit electrons into the tube by heat.

However, there are also tubes that operate in cold cathode mode, whereby electrons are liberated into the tube only by the large potential difference (voltage) between the electrodes. This does not mean the electrodes are cold (indeed, they can be very hot), but it does mean they are operating below their thermionic emission temperature. Because cold cathode lamps have no thermionic emission coating to wear out they can have much longer lives than hot cathode tubes. This quality makes them desirable for maintenance-free long-life applications (such as backlights in liquid crystal displays). Sputtering of the electrode may still occur, but electrodes can be shaped (e.g. into an internal cylinder) to capture most of the sput-

tered material so it is not lost from the electrode.

Cold cathode lamps are generally less efficient than thermionic emission lamps because the cathode fall voltage is much higher. The increased fall voltage results in more power dissipation at tube ends, which does not contribute to light output. However, this is less significant with longer tubes. The increased power dissipation at tube ends also usually means cold cathode tubes have to be run at a lower loading than their thermionic emission equivalents. Given the higher tube voltage required anyway, these tubes can easily be made long, and even run as series strings. They are better suited for bending into special shapes for lettering and signage, and can also be instantly switched on or off.

12.2.6 Starting

The mercury atoms in the fluorescent tube must be ionized before the arc can “strike” within the tube. For small lamps, it does not take much voltage to strike the arc and starting the lamp presents no problem, but larger tubes require a substantial voltage (in the range of a thousand volts).

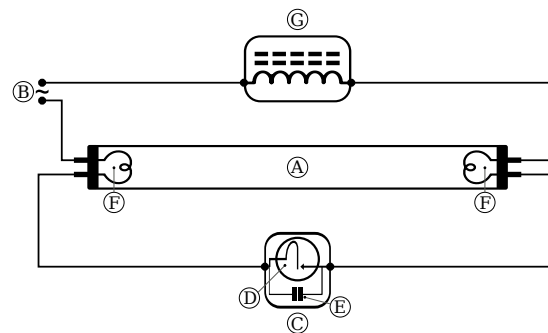

A preheat fluorescent lamp circuit using an automatic starting switch. A: Fluorescent tube, B: Power (+220 volts), C: Starter, D: Switch (bi-metallic thermostat), E: Capacitor, F: Filaments, G: Ballast



Starting a preheat lamp. The automatic starter switch flashes orange each time it attempts to start the lamp.

Preheating

This technique uses a combination filament–cathode at each end of the lamp in conjunction with a mechanical or automatic (bi-metallic) switch (see circuit diagram to the right) that initially connect the filaments in series with the ballast to preheat them; when the arc is struck the filaments are disconnected. This system is described as *pre-heat* in some countries and *switchstart* in others.^[24] These systems are standard equipment in 200–240 V countries (and for 100–120 V lamps up to about 30 watts).

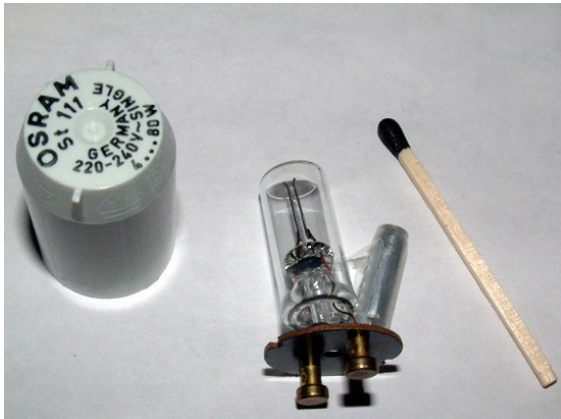

A preheat fluorescent lamp “starter” (automatic starting switch)

Before the 1960s four-pin thermal starters and manual switches were used. A method widely used for preheating from then, and still in common use, is a *glow starter* (illustrated). It consists of a normally open bi-metallic switch in a small sealed inert gas (neon or argon) gas-discharge lamp.

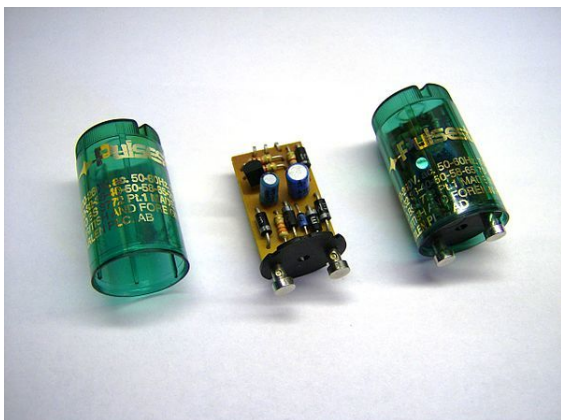

Electronic fluorescent lamp starters

When power is first applied to the circuit, there will be a glow discharge across the electrodes in the starter lamp. This heats the gas in the starter and causes one of the bi-metallic contacts to bend towards the other. When the contacts touch, the two filaments of the fluorescent lamp and the ballast will effectively be switched in series to the supply voltage. The current through the filaments causes them to heat up and emit electrons into

the tube gas by thermionic emission. In the starter, the touching contacts short out the voltage sustaining the glow discharge, extinguishing it so the gas cools down and no longer heats the bi-metallic switch, which opens within a second or two. The current through the filaments and the inductive ballast is abruptly interrupted, leaving the full line voltage applied between the filaments at the ends of the tube and generating an inductive kick which provides the high voltage needed to start the lamp. The lamp will fail to strike if the filaments are not hot enough, in which case the cycle repeats; several cycles are usually needed, which causes flickering and clicking during starting (older thermal starters behaved better in this respect). A power factor correction (PFC) capacitor draws leading current from the mains to compensate for the lagging current drawn by the lamp circuit.^[24]

Once the tube strikes, the impinging main discharge keeps the cathodes hot, permitting continued electron emission without the need for the filaments to continue to be heated. The starter switch does not close again because the voltage across the lit tube is insufficient to start a glow discharge in the starter.^[24]

With automated starters such as glow starters, a failing tube will cycle endlessly, flickering as the lamp quickly goes out because the emission mix is insufficient to keep the lamp current high enough to keep the glow starter open. This runs the ballast at higher temperature. Some more advanced starters time out in this situation, and do not attempt repeated starts until power is reset. Some older systems used a thermal over-current trip to detect repeated starting attempts and disable the circuit until manually reset. The switch contacts in glow starters are subject to wear and inevitably fail eventually, so the starter is manufactured as a plug-in replaceable unit.

More recently introduced electronic starters use a different method to preheat the cathodes.^[25] They may be designed to be plug-in interchangeable with glow starters for use in standard fittings. They commonly use a purpose-designed semiconductor switch and “soft start” the lamp by preheating the cathodes before applying a controlled starting pulse which strikes the lamp first time without flickering; this dislodges a minimal amount of material from the cathodes during starting, giving longer lamp life than possible with the uncontrolled impulses to which the lamp is subjected in a switchstart.^[24] This is claimed to prolong lamp life by a factor of typically 3 to 4 times for a lamp frequently switched on as in domestic use,^[26] and to reduce the blackening of the ends of the lamp typical of fluorescent tubes. The circuit is typically complex, but the complexity is built into the IC. Electronic starters may be optimized for fast starting (typical start time of 0.3 seconds),^{[26][27]} or for most reliable starting even at low temperatures and with low supply voltages, with a startup time of 2–4 seconds.^[28] The faster-start units may produce audible noise during start-up.^[29]

Electronic starters only attempt to start a lamp for a short

time when power is initially applied, and do not repeatedly attempt to restrike a lamp that is dead and unable to sustain an arc; some automatically shut down a failed lamp.^[25] This eliminates the re-striking of a lamp and the continuous flickering of a failing lamp with a glow starter. Electronic starters are not subject to wear and do not need replacing periodically, although they may fail like any other electronic circuit. Manufacturers typically quote lives of 20 years, or as long as the light fitting.^{[27][28]} Starters are inexpensive, typically less than 50 US cents for the short-lived glow type (depending upon lamp power), and perhaps ten times more for the electronic type as of 2013.

Instant start

Another type of tube does not have filaments to start it at all. *Instant start* fluorescent tubes simply use a high enough voltage to break down the gas and mercury column and thereby start arc conduction. These tubes can be identified by a single pin at each end of the tube. The lamp holders have a “disconnect” socket at the low-voltage end which disconnects the ballast when the tube is removed, to prevent electric shock. Low-cost lighting fixtures with an integrated electronic ballast use instant start on lamps designed for preheating, although it shortens lamp life.

Rapid start

Newer *rapid start* ballast designs provide filament power windings within the ballast; these rapidly and continuously warm the filaments/cathodes using low-voltage AC. No inductive voltage spike is produced for starting, so the lamps must be mounted near a grounded (earthed) reflector to allow the glow discharge to propagate through the tube and initiate the arc discharge. In some lamps a grounded “starting aid” strip is attached to the outside of the lamp glass.



A rapid-start “iron” (magnetic) ballast continually heats the cathodes at the ends of the lamps. This ballast runs two F40T12 lamps in series.

Quick-start

Quick-start ballasts use a small auto-transformer to heat the filaments when power is first applied. When an arc strikes, the filament heating power is reduced and the tube will start within half a second. The auto-transformer is either combined with the ballast or may be a separate unit. Tubes need to be mounted near an earthed metal reflector in order for them to strike. Quick-start ballasts are more common in commercial installations because of lower maintenance costs. A quick-start ballast eliminates the need for a starter switch, a common source of lamp failures. Nonetheless, Quick-start ballasts are also used in domestic (residential) installations because of the desirable feature that a Quick-start ballast light turns on nearly immediately after power is applied (when a switch is turned on). Quick-start ballasts are used only on 240 V circuits and are designed for use with the older, less efficient T12 tubes.

Semi-resonant start



A 65 watt fluorescent lamp starting on a semi-resonant start circuit

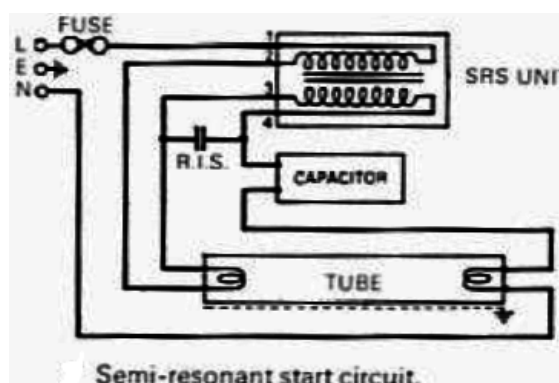

A semi-resonant start circuit diagram

The semi-resonant start circuit was invented by Thorn Lighting for use with T12 fluorescent tubes. This method uses a double wound transformer and a capacitor. With

no arc current, the transformer and capacitor resonate at line frequency and generate about twice the supply voltage across the tube, and a small electrode heating current.^[30] This tube voltage is too low to strike the arc with cold electrodes, but as the electrodes heat up to thermionic emission temperature, the tube striking voltage falls below that of the ringing voltage, and the arc strikes. As the electrodes heat, the lamp slowly, over three to five seconds, reaches full brightness. As the arc current increases and tube voltage drops, the circuit provides current limiting.

Semi-resonant start circuits are mainly restricted to use in commercial installations because of the higher initial cost of circuit components. However, there are no starter switches to be replaced and cathode damage is reduced during starting making lamps last longer, reducing maintenance costs. Due to the high open circuit tube voltage, this starting method is particularly good for starting tubes in cold locations. Additionally, the circuit power factor is almost 1.0, and no additional power factor correction is needed in the lighting installation. As the design requires that twice the supply voltage must be lower than the cold-cathode striking voltage (or the tubes would erroneously instant-start), this design cannot be used with 240 volt AC power unless the tubes are at least 1.5 meter length. Semi-resonant start fixtures are generally incompatible with energy saving T8 retrofit tubes, because such tubes have a higher starting voltage than T12 lamps and may not start reliably, especially in low temperatures. Recent proposals in some countries to phase out T12 tubes will reduce the application of this starting method.

Programmed start

This is used with electronic ballasts shown below. A programmed-start ballast is a more advanced version of rapid start. This ballast applies power to the filaments first, then after a short delay to allow the cathodes to pre-heat, applies voltage to the lamps to strike an arc. This ballast gives the best life and most starts from lamps, and so is preferred for applications with very frequent power cycling such as vision examination rooms and restrooms with a motion detector switch.

Electronic ballasts



Electronic ballast for fluorescent lamp, 2x58W

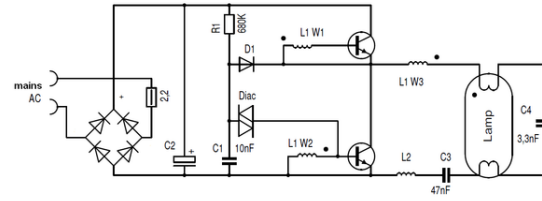

Electronic ballast basic schematic



Fluorescent lamp with an electronic ballast.



Electronic ballasts and different compact fluorescent lamps

Electronic ballasts employ transistors to change the supply frequency into high-frequency AC while also regulating the current flow in the lamp. Some still use an inductance to limit the current, but the higher frequency allows a much smaller inductance to be used. Others use a capacitor-transistor combination to replace the inductor, since a transistor and capacitor working together can simulate the action of an inductor. These ballasts take advantage of the higher efficiency of lamps operated with higher-frequency current, which rises by almost 10% at 10 kHz, compared to efficiency at normal power frequency. When the AC period is shorter than the relaxation time to de-ionize mercury atoms in the discharge column, the discharge stays closer to optimum operating condition.^[31] Electronic ballasts typically work in rapid start or instant start mode. Electronic ballasts are commonly supplied with AC power, which is internally converted to DC and then back to a variable frequency AC waveform. Depending upon the capacitance and the quality of constant-current pulse-width modulation, this can

largely eliminate modulation at 100 or 120 Hz.

Low cost ballasts mostly contain only a simple oscillator and series resonant LC circuit. When turned on, the oscillator starts, and resonant current causes on the LC circuit. And this resonant current directly drive the switching transistor through the ring core transformer. This principle is called the **current resonant inverter** circuit. After a short time the voltage across the lamp reaches about 1 kV and the lamp ignites. The process is too fast to preheat the cathodes, so the lamp instant-starts in cold cathode mode. The cathode filaments are still used for protection of the ballast from overheating if the lamp does not ignite. A few manufacturers use positive temperature coefficient (PTC) thermistors to disable instant starting and give some time to preheat the filaments.

More complex electronic ballasts use programmed start. The output frequency is started above the resonance frequency of the output circuit of the ballast; and after the filaments are heated, the frequency is rapidly decreased. If the frequency approaches the resonant frequency of the ballast, the output voltage will increase so much that the lamp will ignite. If the lamp does not ignite, an electronic circuit stops the operation of the ballast.

Many electronic ballasts are controlled by a microcontroller or similar, and these are sometimes called digital ballasts. Digital ballasts can apply quite complex logic to lamp starting and operation. This enables functions such as testing for broken electrodes and missing tubes before attempting to start, auto detect tube replacement, and auto detection of tube type, such that a single ballast can be used with several different tubes, even those that operate at different arc currents, etc. Once such fine grained control over the starting and arc current is achievable, features such as dimming, and having the ballast maintain a constant light level against changing sunlight contribution are all easily included in the embedded microcontroller software, and can be found in various manufacturers' products.

Since introduction in the 1990s, high-frequency ballasts have been used in general lighting fixtures with either rapid start or pre-heat lamps. These ballasts convert the incoming power to an output frequency in excess of 20 kHz. This increases lamp efficiency. These are used in several applications, including new generation **tanning lamp** systems, whereby a 100 watt lamp (e.g., F71T12BP) can be lit using 90 watts of actual power while obtaining the same **luminous flux** (measured in lumens) as magnetic ballasts.^[32] These ballasts operate with voltages that can be almost 600 volts, requiring some consideration in housing design, and can cause a minor limitation in the length of the wire leads from the ballast to the lamp ends.

12.2.7 End of life

The end of life failure mode for fluorescent lamps varies depending on how they are used and their control gear type. Often the light will turn pink (see **Loss of mercury**) with black burns on the ends of the lamp due to sputtering of **emission mix** (see below). The lamp may also flicker at a noticeable rate (see **Flicker problems**). More information about normal failure modes are as follows:

Emission mix

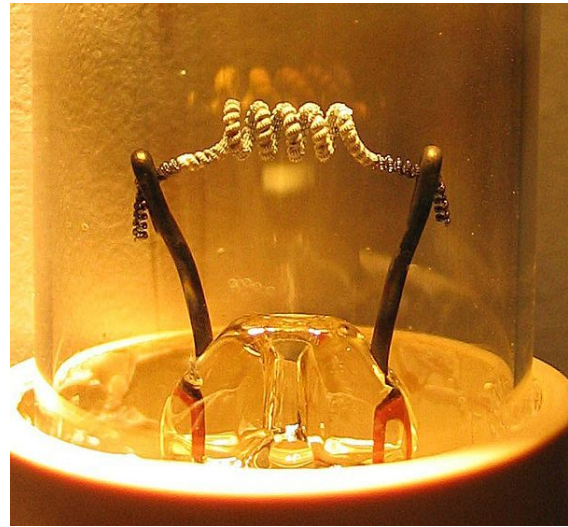

Closeup of the filament on a low pressure mercury gas discharge lamp showing white thermionic emission mix coating on the central portion of the coil acting as hot cathode. Typically made of a mixture of barium, strontium and calcium oxides, the coating is sputtered away through normal use, often eventually resulting in lamp failure.

The "emission mix" on the lamp filaments/cathodes is required to enable electrons to pass into the gas via thermionic emission at the lamp operating voltages used. The mix is slowly sputtered off by bombardment with electrons and mercury ions during operation, but a larger amount is sputtered off each time the lamp is started with cold cathodes. The method of starting the lamp has a significant impact on this. Lamps operated for typically less than 3 hours each switch-on will normally run out of the emission mix before other parts of the lamp fail. The sputtered emission mix forms the dark marks at the lamp ends seen in old lamps. When all the emission mix is gone, the cathode cannot pass sufficient electrons into the gas fill to maintain the gas discharge at the designed lamp operating voltage. Ideally, the control gear should shut down the lamp when this happens. However, due to cost, negative differential resistance and sometimes high starting voltage, some control gear will provide sufficient increased operating voltage to continue lighting the lamp in cold cathode mode. This will cause overheating of the lamp end and rapid disintegration of the electrodes (fila-

ment goes open-circuit) and filament support wires until they are completely gone or the glass cracks, wrecking the low pressure gas fill and stopping the gas discharge.

Ballast electronics

This may occur in compact fluorescent lamps with integral electrical ballasts or in linear lamps. Ballast electronics failure is a somewhat random process that follows the standard failure profile for any electronic device. There is an initial small peak of early failures, followed by a drop and steady increase over lamp life. Life of electronics is heavily dependent on operating temperature—it typically halves for each 10 °C temperature rise. The quoted average life of a lamp is usually at 25 °C (77 °F) ambient (this may vary by country). The average life of the electronics at this temperature is normally greater than this, so at this temperature, not many lamps will fail due to failure of the electronics. In some fittings, the ambient temperature could be well above this, in which case failure of the electronics may become the predominant failure mechanism. Similarly, running a compact fluorescent lamp base-up will result in hotter electronics, which can cause shorter average life (particularly with higher power rated ones). Electronic ballasts should be designed to shut down the tube when the emission mix runs out as described above. In the case of integral electronic ballasts, since they never have to work again, this is sometimes done by having them deliberately burn out some component to permanently cease operation.

In most CFLs the filaments are connected in series, with a small capacitor between them. The discharge, once lit, is in parallel to the capacitor and presents a lower-resistance path, effectively shorting the capacitor out.

Phosphor

The phosphor drops off in efficiency during use. By around 25,000 operating hours, it will typically be half the brightness of a new lamp (although some manufacturers claim much longer half-lives for their lamps). Lamps that do not suffer failures of the emission mix or integral ballast electronics will eventually develop this failure mode. They still work, but have become dim and inefficient. The process is slow, and often becomes obvious only when a new lamp is operating next to an old one.

Loss of mercury

As in all mercury-based gas-filled tubes, mercury is slowly adsorbed into the glass, phosphor, and tube electrodes throughout the life of the lamp, until it can no longer function. Newer lamps have just enough mercury to last the expected life of the lamp. Loss of mercury will take over from failure of the phosphor in some lamps. The failure symptoms are similar, except loss of mercury

initially causes an extended run-up time to full light output, and finally causes the lamp to glow a dim pink when the mercury runs out and the argon base gas takes over as the primary discharge.^[33]

Subjecting the tube to asymmetric waveforms, where the total current flow through the tube does not cancel out and the tube effectively operates under a DC bias, causes asymmetric distribution of mercury ions along the tube due to *cataphoresis*. The localized depletion of mercury vapor pressure manifests as pink luminescence of the base gas in the vicinity of one of the electrodes, and the operating lifetime of the lamp may be dramatically shortened. This can be an issue with some poorly designed inverters.^[34]

Burned filaments

The filaments can burn at the end of the lamp's lifetime, opening the circuit and losing the capability to heat up. Both filaments lose function as they are connected in series, with just a simple switch start circuit a broken filament will render the lamp completely useless. Filaments rarely burn or fail open circuit unless the filament becomes depleted of emitter and the control gear is able to supply a high enough voltage across the tube to operate it in cold cathode mode. Some digital electronic ballasts are capable of detecting broken filaments and can still strike an arc with one or both filaments broken providing there is still sufficient emitter. A broken filament in a lamp attached to a magnetic ballast often causes both lamps to burn out or flicker.

12.3 Phosphors and the spectrum of emitted light



Light from a fluorescent tube lamp reflected by a CD shows the individual bands of color.

The spectrum of light emitted from a fluorescent lamp is the combination of light directly emitted by the mercury vapor, and light emitted by the phosphorescent coating. The spectral lines from the mercury emission and

the phosphorescence effect give a combined spectral distribution of light that is different from those produced by incandescent sources. The relative intensity of light emitted in each narrow band of wavelengths over the visible spectrum is in different proportions compared to that of an incandescent source. Colored objects are perceived differently under light sources with differing spectral distributions. For example, some people find the color rendition produced by some fluorescent lamps to be harsh and displeasing. A healthy person can sometimes appear to have an unhealthy skin tone under fluorescent lighting. The extent to which this phenomenon occurs is related to the light's spectral composition, and may be gauged by its color rendering index (CRI).

12.3.1 Color temperature

Main article: [Color temperature](#)

Correlated color temperature (CCT) is a measure of the

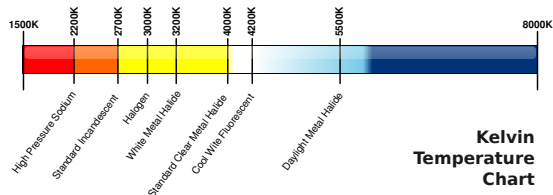

The color temperature of different electric lamps

“shade” of whiteness of a light source compared with a blackbody. Typical incandescent lighting is 2700 K, which is yellowish-white. Halogen lighting is 3000 K. Fluorescent lamps are manufactured to a chosen CCT by altering the mixture of phosphors inside the tube. Warm-white fluorescents have CCT of 2700 K and are popular for residential lighting. Neutral-white fluorescents have a CCT of 3000 K or 3500 K. Cool-white fluorescents have a CCT of 4100 K and are popular for office lighting. Daylight fluorescents have a CCT of 5000 K to 6500 K, which is bluish-white.

High CCT lighting generally requires higher light levels. At dimmer illumination levels, the human eye perceives lower color temperatures as more pleasant, as related through the Kruithof curve. So, a dim 2700 K incandescent lamp appears comfortable and a bright 5000 K lamp also appears natural, but a dim 5000 K fluorescent lamp appears too pale. Daylight-type fluorescents look natural only if they are very bright.

12.3.2 Color rendering index

Main article: [Color rendering index](#)

Color rendering index (CRI) is a measure of how well

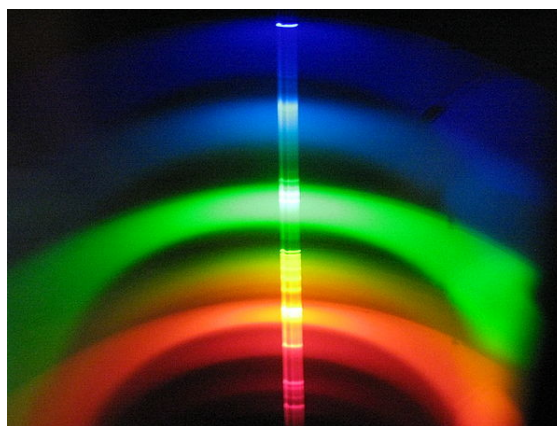

A helical cool-white fluorescent lamp reflected in a diffraction grating reveals the various spectral lines which make up the light.

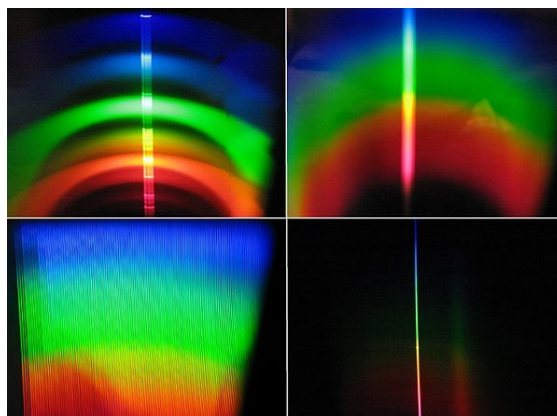

Fluorescent spectra in comparison with other forms of lighting. Clockwise from upper left: Fluorescent lamp, incandescent bulb, candle flame and LED lighting.

colors can be perceived using light from a source, relative to light from a reference source such as daylight or a blackbody of the same color temperature. By definition, an incandescent lamp has a CRI of 100. Real-life fluorescent tubes achieve CRIs of anywhere from 50 to 99. Fluorescent lamps with low CRI have phosphors that emit too little red light. Skin appears less pink, and hence “unhealthy” compared with incandescent lighting. Colored objects appear muted. For example, a low CRI 6800 K halophosphate tube (an extreme example) will make reds appear dull red or even brown. Since the eye is relatively less efficient at detecting red light, an improvement in color rendering index, with increased energy in the red part of the spectrum, may reduce the overall luminous efficacy.^[35]

Lighting arrangements use fluorescent tubes in an assortment of tints of white. Sometimes this is because of the lack of appreciation for the difference or importance of differing tube types. Mixing tube types within fittings can improve the color reproduction of lower quality tubes.

12.3.3 Phosphor composition

Some of the least pleasant light comes from tubes containing the older, halophosphate-type phosphors (chemical formula $\text{Ca}_5(\text{PO}_4)_3(\text{F}, \text{Cl});\text{Sb}^{3+}, \text{Mn}^{2+}$). This phosphor mainly emits yellow and blue light, and relatively little green and red. In the absence of a reference, this mixture appears white to the eye, but the light has an incomplete spectrum. The CRI of such lamps is around 60.

Since the 1990s, higher quality fluorescent lamps use either a higher CRI halophosphate coating, or a *triphosphor* mixture, based on europium and terbium ions, that have emission bands more evenly distributed over the spectrum of visible light. High CRI halophosphate and triphosphor tubes give a more natural color reproduction to the human eye. The CRI of such lamps is typically 82–100.

12.4 Applications

Fluorescent lamps come in many shapes and sizes. The compact fluorescent lamp (CFL) is becoming more popular. Many compact fluorescent lamps integrate the auxiliary electronics into the base of the lamp, allowing them to fit into a regular light bulb socket.

In US residences, fluorescent lamps are mostly found in kitchens, basements, or garages, but schools and businesses find the cost savings of fluorescent lamps to be significant and rarely use incandescent lights. Tax incentives and building codes result in higher use in places such as California.

In other countries, residential use of fluorescent lighting varies depending on the price of energy, financial and environmental concerns of the local population, and acceptability of the light output. In East and Southeast Asia it is very rare to see incandescent bulbs in buildings anywhere.

Some countries are encouraging the phase-out of incandescent light bulbs and substitution of incandescent lamps with fluorescent lamps or other types of energy-efficient lamps.

In addition to general lighting, special fluorescent lights are often used in stage lighting for film and video production. They are cooler than traditional halogen light sources, and use high-frequency ballasts to prevent video flickering and high color-rendition index lamps to approximate daylight color temperatures.

12.5 Advantages

12.5.1 Luminous efficacy

Fluorescent lamps convert more of the input power to visible light than incandescent lamps, though as of 2013

LEDs are sometimes even more efficient and are more rapidly increasing in efficiency. A typical 100 watt tungsten filament incandescent lamp may convert only 5% of its power input to visible white light (400–700 nm wavelength), whereas typical fluorescent lamps convert about 22% of the power input to visible white light.^[36]

The efficacy of fluorescent tubes ranges from about 16 lumens per watt for a 4 watt tube with an ordinary ballast to over 100 lumens per watt^[37] with a modern electronic ballast, commonly averaging 50 to 67 lm/W overall. Most compact fluorescents above 13 watts with integral electronic ballasts achieve about 60 lm/W. Lamps are rated by lumens after 100 hours of operation.^[38] For a given fluorescent tube, a high-frequency electronic ballast gives about a 10% efficacy improvement over an inductive ballast. It is necessary to include the ballast loss when evaluating the efficacy of a fluorescent lamp system; this can be about 25% of the lamp power with magnetic ballasts, and around 10% with electronic ballasts.

Fluorescent lamp efficacy is dependent on lamp temperature at the coldest part of the lamp. In T8 lamps this is in the center of the tube. In T5 lamps this is at the end of the tube with the text stamped on it. The ideal temperature for a T8 lamp is 25 °C (77 °F) while the T5 lamp is ideally at 35 °C (95 °F).

12.5.2 Life

Typically a fluorescent lamp will last 10 to 20 times as long as an equivalent incandescent lamp when operated several hours at a time. Under standard test conditions general lighting lamps have 9,000 hours or longer service life.^[39]

The higher initial cost of a fluorescent lamp compared with an incandescent lamp is usually more than compensated for by lower energy consumption over its life.^[40]

A few manufacturers are producing T8 lamps with 90,000 hour lamp lives, rivalling the life of LED lamps.

12.5.3 Lower luminance

Compared with an incandescent lamp, a fluorescent tube is a more diffuse and physically larger light source. In suitably designed lamps, light can be more evenly distributed without point source of glare such as seen from an undiffused incandescent filament; the lamp is large compared to the typical distance between lamp and illuminated surfaces.

12.5.4 Lower heat

Fluorescent lamps give off about one-fifth the heat of equivalent incandescent lamps. This greatly reduces the size, cost, and energy consumption devoted to air con-

ditioning for office buildings that would typically have many lights and few windows.

12.6 Disadvantages

12.6.1 Frequent switching

If the lamp is installed where it is frequently switched on and off, it will age rapidly.^[41] Under extreme conditions, its lifespan may be much shorter than a cheap incandescent lamp. Each start cycle slightly erodes the electron-emitting surface of the cathodes; when all the emission material is gone, the lamp cannot start with the available ballast voltage. Fixtures intended for flashing of lights (such as for advertising) will use a ballast that maintains cathode temperature when the arc is off, preserving the life of the lamp.

The extra energy used to start a fluorescent lamp is equivalent to a few seconds of normal operation; it is more energy-efficient to switch off lamps when not required for several minutes.^{[42][43]}

12.6.2 Health and safety issues

Main article: [Fluorescent lamps and health](#)

If a fluorescent lamp is broken, a very small amount of mercury can contaminate the surrounding environment. About 99% of the mercury is typically contained in the phosphor, especially on lamps that are near the end of their life.^[44] The broken glass is usually considered a greater hazard than the small amount of spilled mercury. The EPA recommends airing out the location of a fluorescent tube break and using wet paper towels to help pick up the broken glass and fine particles. Any glass and used towels should be disposed of in a sealed plastic bag. Vacuum cleaners can cause the particles to become airborne, and should not be used.^[45]

Fluorescent lamps with magnetic ballasts flicker at a normally unnoticeable frequency of 100 or 120 Hz and this flickering can cause problems for some individuals with light sensitivity,^[46] they are listed as problematic for some individuals with autism, epilepsy,^[47] lupus,^[48] chronic fatigue syndrome, Lyme disease,^[49] and vertigo.^[50] Newer fluorescent lights without magnetic ballasts have essentially eliminated flicker.^[51]

12.6.3 Ultraviolet emission

Fluorescent lamps emit a small amount of ultraviolet (UV) light. A 1993 study in the US found that ultraviolet exposure from sitting under fluorescent lights for eight hours is equivalent to only one minute of sun exposure.^[52] Very sensitive individuals may experience a variety of

health problems relating to light sensitivity that is aggravated by artificial lighting.

The ultraviolet light from a fluorescent lamp can degrade the pigments in paintings (especially watercolor pigments) and bleach the dyes used in textiles and some printing. Valuable art work must be protected from ultraviolet light by placing additional glass or transparent acrylic sheets between the lamp and the art work.

12.6.4 Ballast

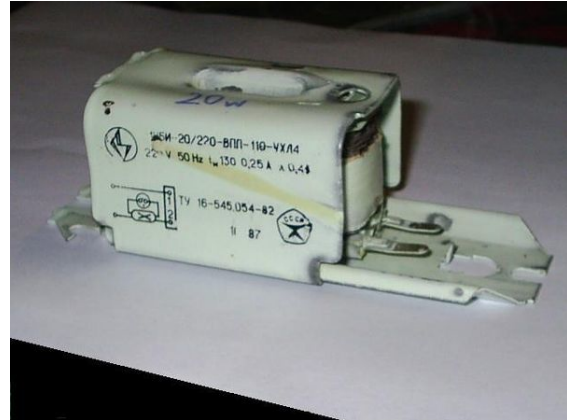

Magnetic single-lamp ballasts have a low power factor.

Fluorescent lamps require a ballast to stabilize the current through the lamp, and to provide the initial striking voltage required to start the arc discharge. This increases the cost of fluorescent light fixtures, though often one ballast is shared between two or more lamps. Electromagnetic ballasts with a minor fault can produce an audible humming or buzzing noise. Magnetic ballasts are usually filled with a tar-like potting compound to reduce emitted noise. Hum is eliminated in lamps with a high-frequency electronic ballast. Energy lost in magnetic ballasts was around 10% of lamp input power according to GE literature from 1978.^[21] Electronic ballasts reduce this loss.

12.6.5 Power quality and radio interference

Simple inductive fluorescent lamp ballasts have a power factor of less than unity. Inductive ballasts include power factor correction capacitors. Simple electronic ballasts may also have low power factor due to their rectifier input stage.

Fluorescent lamps are a non-linear load and generate harmonic currents in the electrical power supply. The arc within the lamp may generate radio frequency noise, which can be conducted through power wiring. Suppression of radio interference is possible. Very good suppression is possible, but adds to the cost of the fluorescent fixtures.

12.6.6 Operating temperature

Fluorescent lamps operate best around room temperature. At much lower or higher temperatures, efficiency decreases. At below-freezing temperatures standard lamps may not start. Special lamps may be needed for reliable service outdoors in cold weather. In applications such as road and railway signalling, fluorescent lamps which do not generate as much heat as incandescent lamps may not melt snow and ice build up around the lamp, leading to reduced visibility.

12.6.7 Lamp shape

Fluorescent tubes are long, low-luminance sources compared with high pressure arc lamps, incandescent lamps and LEDs. However, low luminous intensity of the emitting surface is useful because it reduces glare. Lamp fixture design must control light from a long tube instead of a compact globe.

The compact fluorescent lamp (CFL) replaces regular incandescent bulbs. However, some CFLs will not fit some lamps, because the harp (heavy wire shade support bracket) is shaped for the narrow neck of an incandescent lamp, while CFLs tend to have a wide housing for their electronic ballast close to the lamp's base.

12.6.8 Flicker problems



The “beat effect” problem created when shooting photos under standard fluorescent lighting

Fluorescent lamps using a magnetic power line frequency ballast do not give out a steady light; instead, they flicker at twice the supply frequency. This results in fluctuations not only with light output but color temperature as well,^[53] which may pose problems for photography and people who are sensitive to the flicker. Even among persons not sensitive to light flicker, a stroboscopic effect can be noticed, where something spinning at just the right speed may appear stationary if illuminated solely by a single fluorescent lamp. This effect is eliminated by paired

lamps operating on a lead-lag ballast. Unlike a true strobe lamp, the light level drops in appreciable time and so substantial “blurring” of the moving part would be evident.

In some circumstances, fluorescent lamps operated at the power supply frequency (50 or 60 Hz) can also produce flicker at the same frequency itself, which is noticeable by more people. This can happen in the last few hours of tube life when the cathode emission coating at one end has almost run out, and that cathode starts having difficulty emitting enough electrons into the gas fill, resulting in slight rectification and hence uneven light output in positive and negative going AC cycles. Power frequency flicker can also sometimes be emitted from the very ends of the tubes, if each tube electrode produces a slightly different light output pattern on each half-cycle. Flicker at power frequency is more noticeable in the peripheral vision than it is when viewed directly, as is all flicker (since the peripheral vision is faster—has a higher critical frequency—than the central vision).

Near the end of life, fluorescent lamps can start flickering at a frequency lower than the power frequency. This is due to a dynamic instability inherent in the negative resistance of the plasma source,^[54] which can be from a bad lamp, a bad ballast, or a bad starter; or occasionally from a poor connection to power.

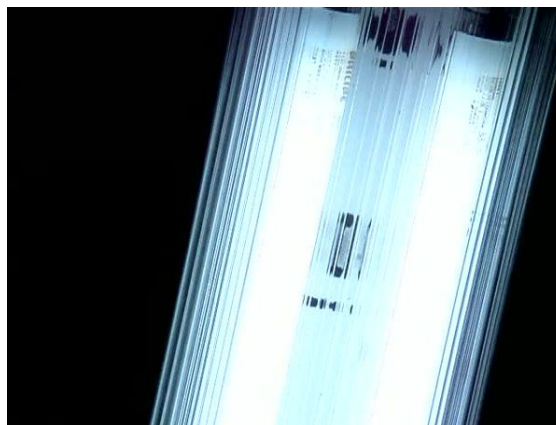

The “beat effect” problem created when shooting films under standard fluorescent lighting

New fluorescent lamps may show a twisting spiral pattern of light in a part of the lamp. This effect is due to loose cathode material and usually disappears after a few hours of operation.^[55]

Electromagnetic ballasts may also cause problems for video recording as there can be a “beat effect” between the periodic reading of a camera’s sensor and the fluctuations in intensity of the fluorescent lamp.

Fluorescent lamps using high-frequency electronic ballasts do not produce visible light flicker, since above about 5 kHz, the excited electron state half-life is longer than a half cycle, and light production becomes continuous. Operating frequencies of electronic ballasts are selected to avoid interference with infrared remote controls.

Poor quality (or failing) electronic ballasts may have insufficient **reservoir capacitance** or have poor regulation, thereby producing considerable 100/120 Hz modulation of the light.

12.6.9 Dimming

Fluorescent light fixtures cannot be connected to **dimmer** switches intended for incandescent lamps. Two effects are responsible for this: the waveform of the voltage emitted by a standard phase-control dimmer interacts badly with many ballasts, and it becomes difficult to sustain an arc in the fluorescent tube at low power levels. Dimming installations require a compatible dimming ballast. These systems keep the cathodes of the fluorescent tube fully heated even as the arc current is reduced, promoting easy **thermionic emission** of electrons into the arc stream. CFLs are available that work in conjunction with a suitable dimmer.

12.6.10 Disposal and recycling

Main article: [Fluorescent lamp recycling](#)

The disposal of phosphor and particularly the toxic **mercury** in the tubes is an environmental issue. Governmental regulations in many areas require special disposal of fluorescent lamps separate from general and household wastes. For large commercial or industrial users of fluorescent lights, recycling services are available in many nations, and may be required by regulation.^{[56][57]} In some areas, recycling is also available to consumers.^[58]

12.7 Lamp sizes and designations

Main article: [Fluorescent lamp formats](#)

Systematic nomenclature identifies mass-market lamps as to general shape, power rating, length, color, and other electrical and illuminating characteristics.

12.8 Other fluorescent lamps

Black lights Blacklights are a subset of fluorescent lamps that are used to provide near ultraviolet light (at about 360 nm wavelength). They are built in the same fashion as conventional fluorescent lamps but the glass tube is coated with a phosphor that converts the short-wave UV within the tube to long-wave UV rather than to visible light. They are used to provoke fluorescence (to provide dramatic effects using **blacklight paint** and to detect materials such as

urine and certain dyes that would be invisible in visible light) as well as to attract insects to **bug zappers**.

So-called **blacklite blue** lamps are also made from more expensive deep purple glass known as **Wood's glass** rather than clear glass. The deep purple glass filters out most of the visible colors of light directly emitted by the mercury-vapor discharge, producing proportionally less visible light compared with UV light. This allows UV-induced fluorescence to be seen more easily (thereby allowing **blacklight posters** to seem much more dramatic). The blacklight lamps used in bug zappers do not require this refinement so it is usually omitted in the interest of cost; they are called simply **blacklite** (and not blacklite blue).

Tanning lamps The lamps used in **tanning beds** contain a different phosphor blend (typically 3 to 5 or more phosphors) that emits both UVA and UVB, provoking a **tanning** response in most human skin. Typically, the output is rated as 3% to 10% UVB (5% most typical) with the remaining UV as UVA. These are mainly F71, F72 or F73 HO (100 W) lamps, although 160 W VHO are somewhat common. One common phosphor used in these lamps is lead-activated barium disilicate, but a europium-activated strontium fluoroborate is also used. Early lamps used **thallium** as an activator, but emissions of thallium during manufacture were toxic.^[59]

UVB Medical lamps The lamps used in **Phototherapy** contain a phosphor that emits only UVB Ultraviolet light. There are two types: **Broadband UVB** that gives 290-320 nanometer with peak wavelength of 306nm, and **Narrowband UVB** that gives 311-313 nanometer. Due to its longer wavelength the **Narrowband UVB** requires a 10 times higher dose to the skin, compared to the broadband. The **Narrowband** is good for Psoriasis, Eczema (Atopic Dermatitis), Vitiligo, Lichen Planus and some other skin diseases. The **Broadband** is better for increasing Vitamin D3 in the body.

Grow lamps Grow lamps contain phosphor blends that encourage **photosynthesis**, growth, or flowering in plants, algae, photosynthetic bacteria, and other light-dependent organisms. These often emit light in the red and blue color range, which is absorbed by **chlorophyll** and used for photosynthesis in plants.^[60]

Infrared lamps Lamps can be made with a lithium metaluminate phosphor activated with iron. This phosphor has peak emissions between 675 and 875 nanometers, with lesser emissions in the deep red part of the visible spectrum.^[61]

Bilirubin lamps Deep blue light generated from a europium-activated phosphor is used in the **light therapy** treatment of jaundice; light of this color penetrates skin and helps in the breakup of excess bilirubin.^[19]

Germicidal lamps Germicidal lamps depend on the property that spectrum of 254 nm kills most germs. Germicidal lamps contain no phosphor at all (making them mercury vapor gas discharge lamps rather than fluorescent) and their tubes are made of fused quartz that is transparent to the UV light emitted by the mercury discharge. The 254 nm UV emitted by these tubes will kill germs and ionize oxygen to ozone. In addition it can cause eye and skin damage and should not be used or observed without eye and skin protection. Besides their uses to kill germs and create ozone, they are sometimes used by geologists to identify certain species of minerals by the color of their fluorescence. When used in this fashion, they are fitted with filters in the same way as blacklight-blue lamps are; the filter passes the short-wave UV and blocks the visible light produced by the mercury discharge. They are also used in some EPROM erasers.

Germicidal lamps have designations beginning with G (meaning 'Germicidal'), rather than F, for example G30T8 for a 30-watt, 1-inch (2.5 cm) diameter, 36-inch (91 cm) long germicidal lamp (as opposed to an F30T8, which would be the fluorescent lamp of the same size and rating).

Electrodeless lamps Electrodeless induction lamps are fluorescent lamps without internal electrodes. They have been commercially available since 1990. A current is induced into the gas column using electromagnetic induction. Because the electrodes are usually the life-limiting element of fluorescent lamps, such electrodeless lamps can have a very long service life, although they also have a higher purchase price.

Cold-cathode fluorescent lamps (CCFL) Cold-cathode fluorescent lamps are used as backlighting for LCD displays in personal computer and TV monitors. They are also popular with computer case modders in recent years.

12.9 Science demonstrations

Fluorescent lamps can be illuminated by means other than a proper electrical connection. These other methods, however, result in very dim or very short-lived illumination, and so are seen mostly in science demonstrations. Static electricity or a Van de Graaff generator will cause a lamp to flash momentarily as it discharges a high voltage capacitance. A Tesla coil will pass high-frequency current through the tube, and since it has a high voltage as well, the gases within the tube will ionize and emit light. Capacitive coupling with high-voltage power lines can light a lamp continuously at low intensity, depending on the intensity of the electrostatic field.



Capacitive coupling with high-voltage power lines can light a lamp continuously at low intensity.

Also, placing a fluorescent lamp half way up a two-way radio antenna while transmitting will illuminate the lamp due to the RF energy.

12.10 See also

- Compact fluorescent lamp
- Fluorescent lamp formats
- Fluorescent lamp recycling
- Fluorescent lamps and health
- Metal halide lamp
- List of light sources
- Gas filled tube

12.11 References

- [1] HTTP 404 Error Message - WA State Dept. of Ecology
- [2] M. A. Laughton *Electrical Engineer's Reference Book Sixteenth Edition*, Newnes, 2003 ISBN 0-7506-4637-3, page 21-12
- [3] Mercury-Containing Light Bulb (Lamp) Recycling | Universal Waste | US EPA
- [4] Gribben, John; "The Scientists; A History of Science Told Through the Lives of Its Greatest Inventors"; Random House; 2004; pp 424-432; ISBN 978-0-8129-6788-3

- [5] See Bright 1949, pp. 381–385 for discussion of early history
- [6] US 865367 *Fluorescent Electric Lamp*
- [7] “Mr. Moore’s Etheric Light. The Young Newark Electrician’s New And Successful Device.”. *New York Times*. October 2, 1896. Retrieved 2008-05-26. Paid access.
- [8] Gaster, Leon; Dow, John Stewart (1915). *Modern illuminants and illuminating engineering*. Whittaker & Co. pp. 107–111.
- [9] Bright, Arthur A., Jr. (1949). *The Electric-Lamp Industry*. MacMillan. Pages 221–223 describe Moore tubes. Pages 369–374 describe neon tube lighting. Page 385 discusses Risler’s contributions to fluorescent coatings in the 1920s. Pages 388–391 discuss the development of the commercial fluorescent at General Electric in the 1930s.
- [10] Weeks, Mary Elvira (2003). *Discovery of the Elements: Third Edition (reprint)*. Kessinger Publishing. p. 287. ISBN 978-0-7661-3872-8.
- [11] Claude, Georges (November 1913). “The Development of Neon Tubes”. *The Engineering Magazine*: 271–274.
- [12] van Dulken, Stephen (2002). *Inventing the 20th century: 100 inventions that shaped the world : from the airplane to the zipper*. New York University Press. p. 42. ISBN 978-0-8147-8812-7.
- [13] US patent 1790153, Albert W. Hull, “Electrical Discharge Device and Method of Operation”, issued 1931-01-27, assigned to General Electric Company
- [14] US patent 2182732, Friedrich Meyer; Hans-Joachim Spanner & Edmund Germer, “Metal Vapor Lamp”, issued 1939-12-05, assigned to General Electric Company
- [15] Lighting A Revolution: 20th Century Store-room
- [16] Kane, Raymond; Sell, Heinz (2001). “A Review of Early Inorganic Phosphors”. *Revolution in lamps: a chronicle of 50 years of progress*. p. 98. ISBN 978-0-88173-378-5.
- [17] William M. Yen, Shigeo Shionoya, Hajime Yamamoto, *Practical Applications of Phosphors*, CRC Press, 2006, ISBN 1-4200-4369-2, pages 84-85
- [18] Kulshreshtha, Alok K. (2009). *Basic Electrical Engineering: Principles and Applications*. India: Tata McGraw-Hill Education. p. 801. ISBN 0-07-014100-2. The partial pressure of the mercury vapor alone is about 0.8 Pa (8 millionths of atmospheric pressure), in a T12 40-watt lamp. See Kane and Sell, 2001, page 185
- [19] Van Broekhoven, Jacob (2001). “Chapter 5: Lamp Phosphors”. In Kane, Raymond; Sell, Heinz. *Revolution in lamps: a chronicle of 50 years of progress* (2nd ed.). The Fairmont Press, Inc. p. 93. ISBN 0-88173-378-4.
- [20] T12 specifies the bulb’s diameter in 1/8 inch units; a T12 bulb is 12×(1/8) inches or 1.5 in (38 mm) in diameter.
- [21] General Electric, *Fluorescent Lamps Technical Bulletin TP 111R*, December 1978 pages 10–11
- [22] page 188
- [23] pages 196–197
- [24] Philips Semiconductor: Power Semiconductor Applications - Lighting, p579
- [25] Datasheet of typical electronic starter (not fast start), with detailed explanation of operation
- [26] Datasheet of typical fast start electronic starter, with detailed explanation of operation
- [27] Data on an ultrafast starter, with nominal startup time of 0.3 seconds
- [28] Data on a typical starter for even adverse conditions, with nominal startup time of 2.4 seconds
- [29] Quick Start for Fluorescent Lights “All three of the ‘FAST’ (< .5 seconds) starter brands caused an audible ‘BURRRRRRR’ noise in some light fittings as they started and this is an inherent problem caused by their use of the faster ‘DC’ heating. It is worse with higher wattage tubes and if there is any loose metal in the light fitting.”
- [30] Thorn Lighting Technical Handbook
- [31] page 182
- [32] “Energy Conservation Standards for Fluorescent Lamp Ballasts” (PDF). US Department of Energy. p. 31. Retrieved 29 January 2012.
- [33]
- [34] http://www.htl.co.jp/img/p_pro4_p10.pdf
- [35] page 8
- [36] page 20
- [37] Panasonic. “Panasonic Spiral Fluorescent ceiling lights, 124.3lm/W”. Retrieved 2010-09-27.
- [38] Klipstein, Donald L. “Light and Lighting Facts and Bits of Data!”. Retrieved 2007-12-29.
- [39] Fink, Donald G.; Beaty, H. Wayne, eds. (1978). *Standard Handbook for Electrical Engineers* (11th ed.). McGraw Hill. pp. 22–17. ISBN 978-0-070-20974-9.
- [40] National Research Council (U.S.). Building Research Institute. *Building illumination: the effect of new lighting levels* Publisher National Academies, 1959. Page 81
- [41] “Compact Fluorescent Lighting” (PDF). eere.energy.gov. Archived from the original (PDF) on May 11, 2011. Retrieved 24 July 2012.
- [42] “Science Fact or Science Fiction: Fluorescent Lights”. *Quirks and Quarks* (CBC). Archived from the original on October 28, 2011. Retrieved 27 October 2011.
- [43] “When to Turn Off Your Lights”. *U.S. Department of Energy*. U.S. Department of Energy. Retrieved 28 November 2012.
- [44] Floyd, et al. (2002), quoted on page 184 of Toolkit for identification and quantification of mercury releases (PDF)

- [45] Fluorescent lamp cleanup Accessed 22 Apr 2009.
- [46] “Working with Light Sensitivity”.
- [47] “Accommodation Ideas for Employees with Epilepsy”.
- [48] “Accommodation and Compliance Series: Employees with Lupus”.
- [49] Shadick NA, Phillips CB, Sangha O et al. (December 1999). “Musculoskeletal and neurologic outcomes in patients with previously treated Lyme disease”. *Ann. Intern. Med.* **131** (12): 919–26. doi:10.7326/0003-4819-131-12-199912210-00003. PMID 10610642.
- [50] “Accommodating People with Vertigo”.
- [51] Lighting flicker, retrieved 2010 April 19
- [52] Lytle, CD; Cyr, WH; Beer, JZ; Miller, SA; James, RH; Landry, RJ; Jacobs, ME; Kaczmarek, RG; Sharkness, CM; Gaylor, D et al. (December 1993). “An Estimation of Squamous Cell Carcinoma Risk from Ultraviolet Radiation Emitted by Fluorescent Lamps”. *Photodermatol Photoimmunol Photomed* **9** (6): 268–74. PMID 1343229.
- [53] “Exposure and Color Temperature Variations When Photographing Under Fluorescent Lights”
- [54] Glozman, Stanislav; Ben-Yaakov, Shmuel (September–October 2001). “Dynamic Interaction Analysis of HF Ballasts and Fluorescent Lamps Based on Envelope Simulation”. *IEEE Transactions on Industry Applications* **37** (5): 1531–1536. doi:10.1109/28.952531.
- [55] page 22
- [56] LampRecycle.org Commercial Lighting: Lamp Recyclers
- [57] EPA.gov Mercury-Containing Light Bulb (Lamp) Regulatory Framework
- [58] EPA.gov Mercury-Containing Light Bulb (Lamp) Collection and Recycling Programs Where You Live
- [59] page 120
- [60] Goins, GD and Yorio, NC and Sanwo, MM and Brown, CS (1997). “Photomorphogenesis, photosynthesis, and seed yield of wheat plants grown under red light-emitting diodes (LEDs) with and without supplemental blue lighting”. *Journal of Experimental Botany* (Soc Experiment Biol) **48** (7): 1407–1413. doi:10.1093/jxb/48.7.1407.
- [61] pg. 122

12.12 Further reading

- Bright, Arthur Aaron (1949). *The Electric-Lamp Industry: Technological Change and Economic Development from 1800 to 1947*. Macmillan Co.
- Emanuel Gluskin, “The fluorescent lamp circuit”, (Circuits & Systems Expositions)
- IEEE Transactions on Circuits and Systems, Part I: Fundamental Theory and Applications 46(5), 1999 (529-544).

12.13 External links

- *Popular Science*, January 1940 *Fluorescent Lamps*
- T5 Fluorescent Systems — Lighting Research Center Research about the improved T5 relative to the previous T8 standard
- NASA: The Fluorescent Lamp: A plasma you can use
- How Fluorescent Tubes are Manufactured on YouTube
- Museum of Electric Lamp Technology
- R. N. Thayer (1991-10-25). “The Fluorescent Lamp: Early U. S. Development”. The Report courtesy of General Electric Company. Retrieved 2007-03-18.
- Wiebe E. Bijker, *Of bicycles, bakelites, and bulbs: toward a theory of sociotechnical change* MIT Press, 1995, Chapter 4, preview available at Google Books, on the social construction of fluorescent lighting
- Explanations and schematics of some fluorescent lamps

Chapter 13

Electric discharge

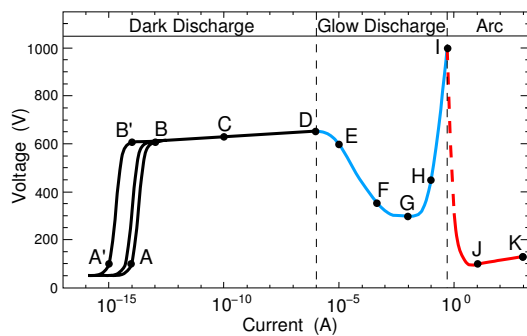

Voltage versus current characteristics for neon gas at 1 Torr pressure between flat electrodes spaced 50 cm. A-D dark discharge, D-I glow discharge, I-K arc. A-B represent non-self-sustaining discharge and collection of spontaneously-generated ions. B-D is the Townsend region, where the cascade multiplication of carriers takes place. D-E is the transition to a glow discharge, breakdown of the gas. E-G represents transition to a normal glow; in the regions around G, voltage is nearly constant for varying current. The region G-I represents abnormal glow, as current density rises. I-J represents transition to an arc discharge.

Electric discharge describes any flow of electric charge through a gas, liquid or solid. Electric discharges include:

- Brush discharge
- Dielectric barrier discharge
- Corona discharge
- Electric glow discharge
- Electric arc
- Electrostatic discharge
- Electric discharge in gases
- Leader (spark)
- Partial discharge
- Streamer discharge
- Vacuum arc
- Townsend discharge

13.1 Applications

The properties and effects of electric discharges are useful over a wide range of magnitudes. Tiny pulses of current are used to detect ionizing radiation in a Geiger-Müller tube. A low steady current can be used to illustrate the spectrum of gases in a Gas-filled tube. A neon lamp is an example of a gas-discharge lamp, useful both for illumination and as a voltage regulator. A flashtube generates a short pulse of intense light useful for photography by sending a heavy current through a gas arc discharge. Corona discharges are used in photocopiers.

Electric discharges can convey substantial energy to the electrodes at the ends of the discharge. A spark gap is used in internal combustion engines to ignite the fuel/air mixture on every power stroke. Spark gaps are also used to switch heavy currents in a Marx generator and to protect electrical apparatus. In electric discharge machining, multiple tiny electric arcs are used to erode a conductive workpiece to a finished shape. Arc welding is used to assemble heavy steel structures, where the base metal is heated to melting by the heat of the arc. An electric arc furnace sustains arc currents of tens of thousands of amperes and is used for steelmaking and production of alloys and other products.

13.2 Natural phenomena

- St. Elmo's fire
- Lightning
- Electric organ

13.3 See also

- Electrical breakdown
- Electric discharge in gases
- E/N ratio
- Lichtenberg figure

- Space charge
- Debye sheath

Chapter 14

Plasma (physics)

For other uses, see Plasma.

Plasma (from Greek πλάσμα, “anything formed”^[1]) is one of the four fundamental states of matter, the others being solid, liquid, and gas. A plasma has properties unlike those of the other states.

A plasma can be created by heating a gas or subjecting it to a strong electromagnetic field applied with a laser or microwave generator. This decreases or increases the number of electrons, creating positive or negative charged particles called ions,^[2] and is accompanied by the dissociation of molecular bonds, if present.^[3]

The presence of a significant number of charge carriers makes plasma electrically conductive so that it responds strongly to electromagnetic fields. Like gas, plasma does not have a definite shape or a definite volume unless enclosed in a container. Unlike gas, under the influence of a magnetic field, it may form structures such as filaments, beams and double layers.

Plasma is the most abundant form of ordinary matter in the Universe, most of which is in the rarefied intergalactic regions, particularly the intracluster medium, and in stars, including the Sun.^{[4][5]} A common form of plasmas on Earth is seen in neon signs.

Much of the understanding of plasmas has come from the pursuit of controlled nuclear fusion and fusion power, for which plasma physics provides the scientific basis.

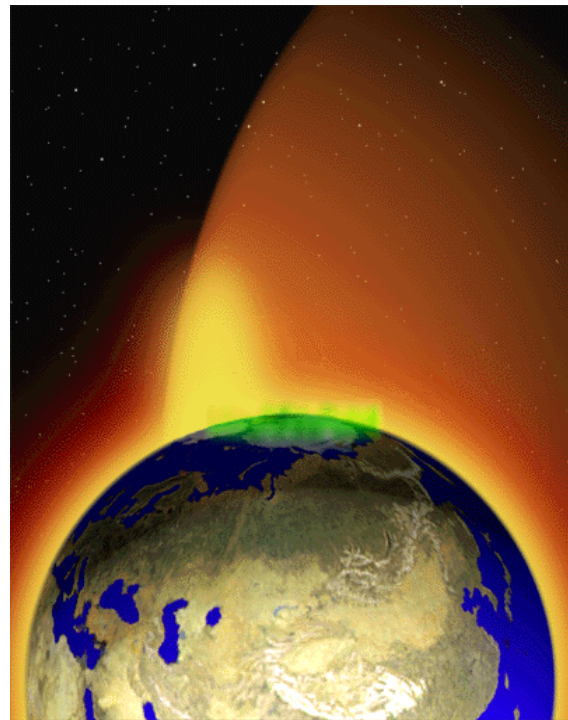

Artist's rendition of the Earth's plasma fountain, showing oxygen, helium, and hydrogen ions that gush into space from regions near the Earth's poles. The faint yellow area shown above the north pole represents gas lost from Earth into space; the green area is the aurora borealis, where plasma energy pours back into the atmosphere.^[6]

14.1 Properties and parameters

14.1.1 Definition

Plasma is loosely described as an electrically neutral medium of unbound positive and negative particles (i.e. the overall charge of a plasma is roughly zero). It is important to note that although they are unbound, these particles are not ‘free’ in the sense of not experiencing forces. When the charges move, they generate electrical currents with magnetic fields, and as a result, they are affected by each other's fields. This governs their collective behavior with many degrees of freedom.^{[3][7]} A definition can

have three criteria:^{[8][9]}

1. **The plasma approximation:** Charged particles must be close enough together that each particle influences many nearby charged particles, rather than just interacting with the closest particle (these collective effects are a distinguishing feature of a plasma). The plasma approximation is valid when the number of charge carriers within the sphere of influence (called the *Debye sphere* whose radius is the Debye screening length) of a particular particle is higher than unity to provide collective behavior of the charged particles. The average number of particles in the Debye sphere is given by the plasma pa-

parameter, " Λ " (the Greek letter Lambda).

2. **Bulk interactions:** The Debye screening length (defined above) is short compared to the physical size of the plasma. This criterion means that interactions in the bulk of the plasma are more important than those at its edges, where boundary effects may take place. When this criterion is satisfied, the plasma is quasineutral.
3. **Plasma frequency:** The electron plasma frequency (measuring plasma oscillations of the electrons) is large compared to the electron-neutral collision frequency (measuring frequency of collisions between electrons and neutral particles). When this condition is valid, electrostatic interactions dominate over the processes of ordinary gas kinetics.

14.1.2 Ranges of parameters

Plasma parameters can take on values varying by many orders of magnitude, but the properties of plasmas with apparently disparate parameters may be very similar (see plasma scaling). The following chart considers only conventional atomic plasmas and not exotic phenomena like quark gluon plasmas:

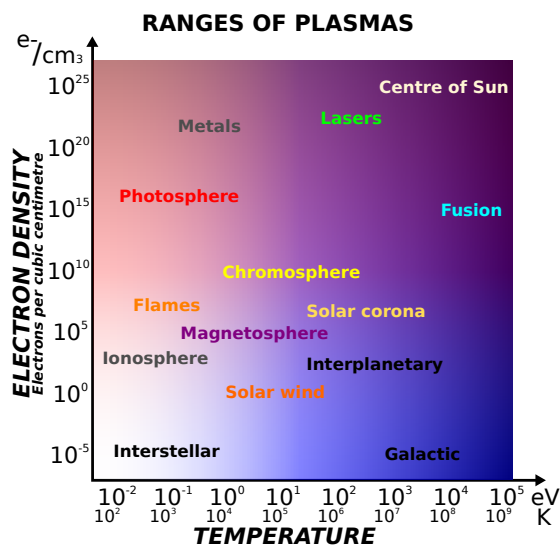

Range of plasmas. Density increases upwards, temperature increases towards the right. The free electrons in a metal may be considered an electron plasma.^[10]

14.1.3 Degree of ionization

For plasma to exist, ionization is necessary. The term "plasma density" by itself usually refers to the "electron density", that is, the number of free electrons per unit volume. The degree of ionization of a plasma is the proportion of atoms that have lost or gained electrons, and

is controlled mostly by the temperature. Even a partially ionized gas in which as little as 1% of the particles are ionized can have the characteristics of a plasma (i.e., response to magnetic fields and high electrical conductivity). The degree of ionization, α , is defined as $\alpha = \frac{n_i}{n_i + n_n}$, where n_i is the number density of ions and n_n is the number density of neutral atoms. The electron density is related to this by the average charge state $\langle Z \rangle$ of the ions through $n_e = \langle Z \rangle n_i$, where n_e is the number density of electrons.

14.1.4 Temperatures

See also: Nonthermal plasma

Plasma temperature is commonly measured in Kelvins or electronvolts and is, informally, a measure of the thermal kinetic energy per particle. Very high temperatures are usually needed to sustain ionization, which is a defining feature of a plasma. The degree of plasma ionization is determined by the electron temperature relative to the ionization energy (and more weakly by the density), in a relationship called the Saha equation. At low temperatures, ions and electrons tend to recombine into bound states—atoms^[12]—and the plasma will eventually become a gas.

In most cases the electrons are close enough to thermal equilibrium that their temperature is relatively well-defined, even when there is a significant deviation from a Maxwellian energy distribution function, for example, due to UV radiation, energetic particles, or strong electric fields. Because of the large difference in mass, the electrons come to thermodynamic equilibrium amongst themselves much faster than they come into equilibrium with the ions or neutral atoms. For this reason, the ion temperature may be very different from (usually lower than) the electron temperature. This is especially common in weakly ionized technological plasmas, where the ions are often near the ambient temperature.

Thermal vs. non-thermal plasmas

Based on the relative temperatures of the electrons, ions and neutrals, plasmas are classified as "thermal" or "non-thermal". Thermal plasmas have electrons and the heavy particles at the same temperature, i.e. they are in thermal equilibrium with each other. Non-thermal plasmas on the other hand have the ions and neutrals at a much lower temperature (sometimes room temperature), whereas electrons are much "hotter" ($T_e \gg T_n$).

A plasma is sometimes referred to as being "hot" if it is nearly fully ionized, or "cold" if only a small fraction (for example 1%) of the gas molecules are ionized, but other definitions of the terms "hot plasma" and "cold plasma" are common. Even in a "cold" plasma, the electron temperature is still typically several thousand degrees Celsius.

Plasmas utilized in “plasma technology” (“technological plasmas”) are usually cold plasmas in the sense that only a small fraction of the gas molecules are ionized.

14.1.5 Plasma potential



Lightning is an example of plasma present at Earth’s surface. Typically, lightning discharges 30,000 amperes at up to 100 million volts, and emits light, radio waves, X-rays and even gamma rays.^[13] Plasma temperatures in lightning can approach 28,000 K (28,000 °C; 50,000 °F) and electron densities may exceed 10^{24} m^{-3} .

Since plasmas are very good electrical conductors, electric potentials play an important role. The potential as it exists on average in the space between charged particles, independent of the question of how it can be measured, is called the “plasma potential”, or the “space potential”. If an electrode is inserted into a plasma, its potential will generally lie considerably below the plasma potential due to what is termed a Debye sheath. The good electrical conductivity of plasmas makes their electric fields very small. This results in the important concept of “quasineutrality”, which says the density of negative charges is approximately equal to the density of positive charges over large volumes of the plasma ($n_e = \langle Z \rangle n_i$), but on the scale of the Debye length there can be charge imbalance. In the special case that *double layers* are formed, the charge separation can extend some tens of Debye lengths.

The magnitude of the potentials and electric fields must be determined by means other than simply finding the net charge density. A common example is to assume that the electrons satisfy the Boltzmann relation:

$$n_e \propto e^{e\Phi/k_B T_e}.$$

Differentiating this relation provides a means to calculate the electric field from the density:

$$\vec{E} = (k_B T_e / e)(\nabla n_e / n_e).$$

It is possible to produce a plasma that is not quasineutral. An electron beam, for example, has only negative charges. The density of a non-neutral plasma must generally be very low, or it must be very small, otherwise it will be dissipated by the repulsive electrostatic force.

In astrophysical plasmas, Debye screening prevents electric fields from directly affecting the plasma over large distances, i.e., greater than the Debye length. However, the existence of charged particles causes the plasma to generate, and be affected by, magnetic fields. This can and does cause extremely complex behavior, such as the generation of plasma double layers, an object that separates charge over a few tens of Debye lengths. The dynamics of plasmas interacting with external and self-generated magnetic fields are studied in the academic discipline of magnetohydrodynamics.

14.1.6 Magnetization

Plasma with a magnetic field strong enough to influence the motion of the charged particles is said to be magnetized. A common quantitative criterion is that a particle on average completes at least one gyration around the magnetic field before making a collision, i.e., $\omega_{ce} / \nu_{coll} > 1$, where ω_{ce} is the “electron gyrofrequency” and ν_{coll} is the “electron collision rate”. It is often the case that the electrons are magnetized while the ions are not. Magnetized plasmas are *anisotropic*, meaning that their properties in the direction parallel to the magnetic field are different from those perpendicular to it. While electric fields in plasmas are usually small due to the high conductivity, the electric field associated with a plasma moving in a magnetic field is given by $\mathbf{E} = -\mathbf{v} \times \mathbf{B}$ (where \mathbf{E} is the electric field, \mathbf{v} is the velocity, and \mathbf{B} is the magnetic field), and is not affected by Debye shielding.^[14]

14.1.7 Comparison of plasma and gas phases

Plasma is often called the *fourth state of matter* after solid, liquids and gases.^{[15][16]} It is distinct from these and other lower-energy states of matter. Although it is closely

related to the gas phase in that it also has no definite form or volume, it differs in a number of ways, including the following:

14.2 Common plasmas

Further information: *Astrophysical plasma, Interstellar medium and Intergalactic space*

Plasmas are by far the most common phase of ordinary matter in the universe, both by mass and by volume.^[18] Essentially, all of the visible light from space comes from stars, which are plasmas with a temperature such that they radiate strongly at visible wavelengths. Most of the ordinary (or baryonic) matter in the universe, however, is found in the intergalactic medium, which is also a plasma, but much hotter, so that it radiates primarily as X-rays.

In 1937, Hannes Alfvén argued that if plasma pervaded the universe, it could then carry electric currents capable of generating a galactic magnetic field.^[19] After winning the Nobel Prize, he emphasized that:

In order to understand the phenomena in a certain plasma region, it is necessary to map not only the magnetic but also the electric field and the electric currents. Space is filled with a network of currents which transfer energy and momentum over large or very large distances. The currents often pinch to filamentary or surface currents. The latter are likely to give space, as also interstellar and intergalactic space, a cellular structure.^[20]

By contrast the current scientific consensus is that about 96% of the total energy density in the universe is not plasma or any other form of ordinary matter, but a combination of cold dark matter and dark energy. Our Sun, and all stars, are made of plasma, much of interstellar space is filled with a plasma, albeit a very sparse one, and intergalactic space too. Even black holes, which are not directly visible, are thought to be fuelled by accreting ionising matter (i.e. plasma),^[21] and they are associated with astrophysical jets of luminous ejected plasma,^[22] such as M87's jet that extends 5,000 light-years.^[23]

In our solar system, interplanetary space is filled with the plasma of the Solar Wind that extends from the Sun out to the heliopause. However, the density of ordinary matter is much higher than average and much higher than that of either dark matter or dark energy. The planet Jupiter accounts for most of the non-plasma, only about 0.1% of the mass and 10^{-15} % of the volume within the orbit of Pluto.

Dust and small grains within a plasma will also pick up a net negative charge, so that they in turn may act like

a very heavy negative ion component of the plasma (see dusty plasmas).

14.3 Complex plasma phenomena

Although the underlying equations governing plasmas are relatively simple, plasma behavior is extraordinarily varied and subtle: the emergence of unexpected behavior from a simple model is a typical feature of a complex system. Such systems lie in some sense on the boundary between ordered and disordered behavior and cannot typically be described either by simple, smooth, mathematical functions, or by pure randomness. The spontaneous formation of interesting spatial features on a wide range of length scales is one manifestation of plasma complexity. The features are interesting, for example, because they are very sharp, spatially intermittent (the distance between features is much larger than the features themselves), or have a fractal form. Many of these features were first studied in the laboratory, and have subsequently been recognized throughout the universe. Examples of complexity and complex structures in plasmas include:

14.3.1 Filamentation

Striations or string-like structures,^[27] also known as birkeland currents, are seen in many plasmas, like the plasma ball, the aurora,^[28] lightning,^[29] electric arcs, solar flares,^[30] and supernova remnants.^[31] They are sometimes associated with larger current densities, and the interaction with the magnetic field can form a magnetic rope structure.^[32] High power microwave breakdown at atmospheric pressure also leads to the formation of filamentary structures.^[33] (See also Plasma pinch)

Filamentation also refers to the self-focusing of a high power laser pulse. At high powers, the nonlinear part of the index of refraction becomes important and causes a higher index of refraction in the center of the laser beam, where the laser is brighter than at the edges, causing a feedback that focuses the laser even more. The tighter focused laser has a higher peak brightness (irradiance) that forms a plasma. The plasma has an index of refraction lower than one, and causes a defocusing of the laser beam. The interplay of the focusing index of refraction, and the defocusing plasma makes the formation of a long filament of plasma that can be micrometers to kilometers in length.^[34] One interesting aspect of the filamentation generated plasma is the relatively low ion density due to defocusing effects of the ionized electrons.^[35] (See also Filament propagation)

14.3.2 Shocks or double layers

Plasma properties change rapidly (within a few Debye lengths) across a two-dimensional sheet in the presence of a (moving) shock or (stationary) double layer. Double layers involve localized charge separation, which causes a large potential difference across the layer, but does not generate an electric field outside the layer. Double layers separate adjacent plasma regions with different physical characteristics, and are often found in current carrying plasmas. They accelerate both ions and electrons.

14.3.3 Electric fields and circuits

Quasineutrality of a plasma requires that plasma currents close on themselves in electric circuits. Such circuits follow Kirchhoff's circuit laws and possess a resistance and inductance. These circuits must generally be treated as a strongly coupled system, with the behavior in each plasma region dependent on the entire circuit. It is this strong coupling between system elements, together with non-linearity, which may lead to complex behavior. Electrical circuits in plasmas store inductive (magnetic) energy, and should the circuit be disrupted, for example, by a plasma instability, the inductive energy will be released as plasma heating and acceleration. This is a common explanation for the heating that takes place in the solar corona. Electric currents, and in particular, magnetic-field-aligned electric currents (which are sometimes generically referred to as "Birkeland currents"), are also observed in the Earth's aurora, and in plasma filaments.

14.3.4 Cellular structure

Narrow sheets with sharp gradients may separate regions with different properties such as magnetization, density and temperature, resulting in cell-like regions. Examples include the magnetosphere, heliosphere, and heliospheric current sheet. Hannes Alfvén wrote: "From the cosmological point of view, the most important new space research discovery is probably the cellular structure of space. As has been seen in every region of space accessible to in situ measurements, there are a number of 'cell walls', sheets of electric currents, which divide space into compartments with different magnetization, temperature, density, etc."^[36]

14.3.5 Critical ionization velocity

The critical ionization velocity is the relative velocity between an ionized plasma and a neutral gas, above which a runaway ionization process takes place. The critical ionization process is a quite general mechanism for the conversion of the kinetic energy of a rapidly streaming gas

into ionization and plasma thermal energy. Critical phenomena in general are typical of complex systems, and may lead to sharp spatial or temporal features.

14.3.6 Ultracold plasma

Ultracold plasmas are created in a magneto-optical trap (MOT) by trapping and cooling neutral atoms, to temperatures of 1 mK or lower, and then using another laser to ionize the atoms by giving each of the outermost electrons just enough energy to escape the electrical attraction of its parent ion.

One advantage of ultracold plasmas are their well characterized and tunable initial conditions, including their size and electron temperature. By adjusting the wavelength of the ionizing laser, the kinetic energy of the liberated electrons can be tuned as low as 0.1 K, a limit set by the frequency bandwidth of the laser pulse. The ions inherit the millikelvin temperatures of the neutral atoms, but are quickly heated through a process known as disorder induced heating (DIH). This type of non-equilibrium ultracold plasma evolves rapidly, and displays many other interesting phenomena.^[37]

One of the metastable states of a strongly nonideal plasma is Rydberg matter, which forms upon condensation of excited atoms.

14.3.7 Non-neutral plasma

The strength and range of the electric force and the good conductivity of plasmas usually ensure that the densities of positive and negative charges in any sizeable region are equal ("quasineutrality"). A plasma with a significant excess of charge density, or, in the extreme case, is composed of a single species, is called a non-neutral plasma. In such a plasma, electric fields play a dominant role. Examples are charged particle beams, an electron cloud in a Penning trap and positron plasmas.^[38]

14.3.8 Dusty plasma/grain plasma

A dusty plasma contains tiny charged particles of dust (typically found in space). The dust particles acquire high charges and interact with each other. A plasma that contains larger particles is called grain plasma. Under laboratory conditions, dusty plasmas are also called complex plasmas.^[39]

14.3.9 Impermeable plasma

Impermeable plasma is a type of thermal plasma which acts like an impermeable solid with respect to gas or cold plasma and can be physically pushed. Interaction of cold gas and thermal plasma was briefly studied by a group

led by Hannes Alfvén in 1960s and 1970s for its possible applications in insulation of fusion plasma from the reactor walls.^[40] However later it was found that the external magnetic fields in this configuration could induce kink instabilities in the plasma and subsequently lead to an unexpectedly high heat loss to the walls.^[41] In 2013, a group of materials scientists reported that they have successfully generated stable impermeable plasma with no magnetic confinement using only an ultrahigh-pressure blanket of cold gas. While spectroscopic data on the characteristics of plasma were claimed to be difficult to obtain due to the high-pressure, the passive effect of plasma on synthesis of different nanostructures clearly suggested the effective confinement. They also showed that upon maintaining the impermeability for a few tens of seconds, screening of ions at the plasma-gas interface could give rise to a strong secondary mode of heating (known as viscous heating) leading to different kinetics of reactions and formation of complex nanomaterials.^[42]

14.4 Mathematical descriptions

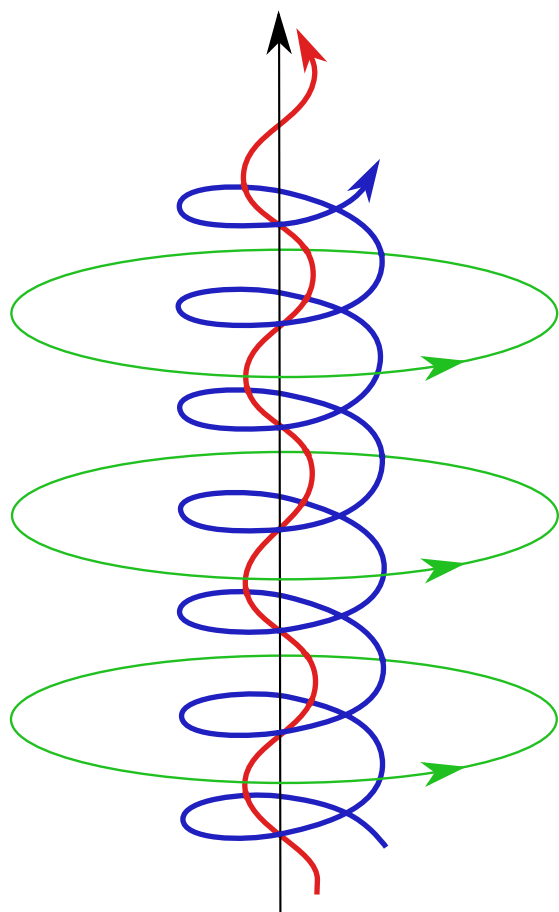

The complex self-constricting magnetic field lines and current paths in a field-aligned Birkeland current that can develop in a plasma.^[43]

Main article: Plasma modeling

To completely describe the state of a plasma, we would need to write down all the particle locations and velocities and describe the electromagnetic field in the plasma region. However, it is generally not practical or necessary to keep track of all the particles in a plasma. Therefore, plasma physicists commonly use less detailed descriptions, of which there are two main types:

14.4.1 Fluid model

Fluid models describe plasmas in terms of smoothed quantities, like density and averaged velocity around each position (see Plasma parameters). One simple fluid model, magnetohydrodynamics, treats the plasma as a single fluid governed by a combination of Maxwell's equations and the Navier–Stokes equations. A more general description is the two-fluid plasma picture, where the ions and electrons are described separately. Fluid models are often accurate when collisionality is sufficiently high to keep the plasma velocity distribution close to a Maxwell–Boltzmann distribution. Because fluid models usually describe the plasma in terms of a single flow at a certain temperature at each spatial location, they can neither capture velocity space structures like beams or double layers, nor resolve wave-particle effects.

14.4.2 Kinetic model

Kinetic models describe the particle velocity distribution function at each point in the plasma and therefore do not need to assume a Maxwell–Boltzmann distribution. A kinetic description is often necessary for collisionless plasmas. There are two common approaches to kinetic description of a plasma. One is based on representing the smoothed distribution function on a grid in velocity and position. The other, known as the particle-in-cell (PIC) technique, includes kinetic information by following the trajectories of a large number of individual particles. Kinetic models are generally more computationally intensive than fluid models. The Vlasov equation may be used to describe the dynamics of a system of charged particles interacting with an electromagnetic field. In magnetized plasmas, a gyrokinetic approach can substantially reduce the computational expense of a fully kinetic simulation.

14.5 Artificial plasmas

Most artificial plasmas are generated by the application of electric and/or magnetic fields. Plasma generated in a laboratory setting and for industrial use can be generally categorized by:

- The type of power source used to generate the plasma—DC, RF and microwave

- The pressure they operate at—vacuum pressure (< 10 mTorr or 1 Pa), moderate pressure (~ 1 Torr or 100 Pa), atmospheric pressure (760 Torr or 100 kPa)
- The degree of ionization within the plasma—fully, partially, or weakly ionized
- The temperature relationships within the plasma—thermal plasma ($T_e = T_i = T_{gas}$), non-thermal or “cold” plasma ($T_e \gg T_i = T_{gas}$)
- The electrode configuration used to generate the plasma
- The magnetization of the particles within the plasma—magnetized (both ion and electrons are trapped in Larmor orbits by the magnetic field), partially magnetized (the electrons but not the ions are trapped by the magnetic field), non-magnetized (the magnetic field is too weak to trap the particles in orbits but may generate Lorentz forces)
- The application.

14.5.1 Generation of artificial plasma

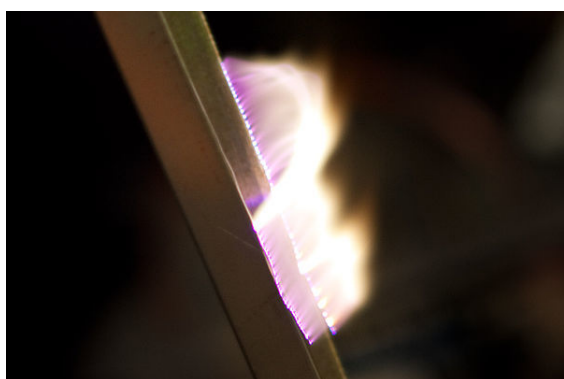
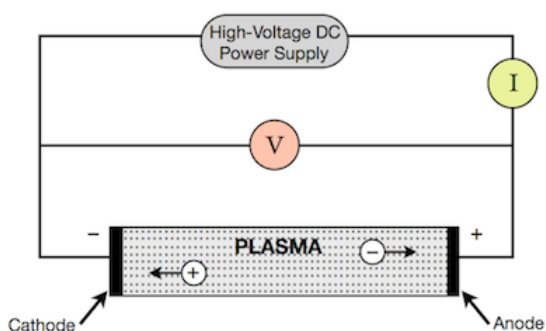

Artificial plasma produced in air by a Jacob's Ladder

Just like the many uses of plasma, there are several means for its generation, however, one principle is common to all of them: there must be energy input to produce and sustain it.^[44] For this case, plasma is generated when an

electrical current is applied across a dielectric gas or fluid (an electrically non-conducting material) as can be seen in the image to the right, which shows a discharge tube as a simple example (DC used for simplicity).

The potential difference and subsequent electric field pull the bound electrons (negative) toward the anode (positive electrode) while the cathode (negative electrode) pulls the nucleus.^[45] As the voltage increases, the current stresses the material (by electric polarization) beyond its dielectric limit (termed strength) into a stage of electrical breakdown, marked by an electric spark, where the material transforms from being an insulator into a conductor (as it becomes increasingly ionized). The underlying process is the Townsend avalanche, where collisions between electrons and neutral gas atoms create more ions and electrons (as can be seen in the figure on the right). The first impact of an electron on an atom results in one ion and two electrons. Therefore, the number of charged particles increases rapidly (in the millions) only “after about 20 successive sets of collisions”,^[46] mainly due to a small mean free path (average distance travelled between collisions).

Electric arc

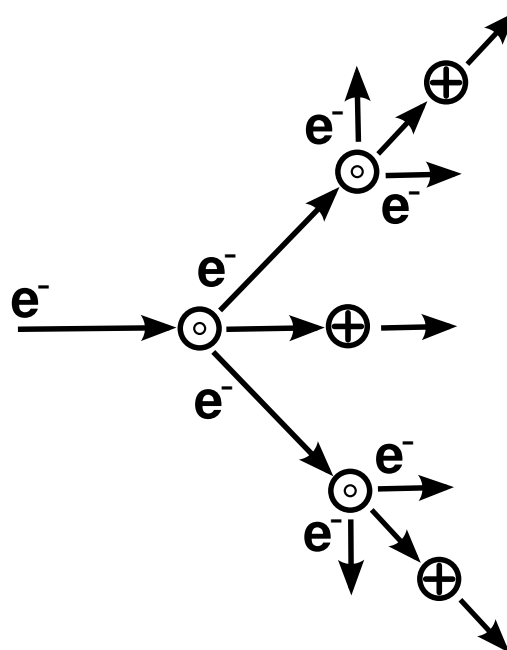

Cascade process of ionization. Electrons are ‘e-’, neutral atoms ‘o’, and cations ‘+’.

With ample current density and ionization, this forms a luminous electric arc (a continuous electric discharge similar to lightning) between the electrodes.^[Note 1] Electrical resistance along the continuous electric arc creates heat, which dissociates more gas molecules and ionizes the resulting atoms (where degree of ionization is determined by temperature), and as per the sequence: solid-liquid-gas-plasma, the gas is gradually turned into

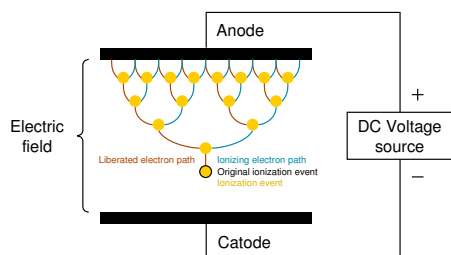

Avalanche effect between two electrodes. The original ionisation event liberates one electron, and each subsequent collision liberates a further electron, so two electrons emerge from each collision: the ionising electron and the liberated electron.

a thermal plasma.^[Note 2] A thermal plasma is in thermal equilibrium, which is to say that the temperature is relatively homogeneous throughout the heavy particles (i.e. atoms, molecules and ions) and electrons. This is so because when thermal plasmas are generated, electrical energy is given to electrons, which, due to their great mobility and large numbers, are able to disperse it rapidly and by elastic collision (without energy loss) to the heavy particles.^{[47][Note 3]}

14.5.2 Examples of industrial/commercial plasma

Because of their sizable temperature and density ranges, plasmas find applications in many fields of research, technology and industry. For example, in: industrial and extractive metallurgy,^[47] surface treatments such as plasma spraying (coating), etching in microelectronics,^[48] metal cutting^[49] and welding; as well as in everyday vehicle exhaust cleanup and fluorescent/luorescent lamps,^[44] while even playing a part in supersonic combustion engines for aerospace engineering.^[50]

Low-pressure discharges

- *Glow discharge plasmas*: non-thermal plasmas generated by the application of DC or low frequency RF (<100 kHz) electric field to the gap between two metal electrodes. Probably the most common plasma; this is the type of plasma generated within fluorescent light tubes.^[51]
- *Capacitively coupled plasma (CCP)*: similar to glow discharge plasmas, but generated with high frequency RF electric fields, typically 13.56 MHz. These differ from glow discharges in that the sheaths are much less intense. These are widely used in the microfabrication and integrated circuit manufacturing industries for plasma etching and plasma enhanced chemical vapor deposition.^[52]

- *Cascaded Arc Plasma Source*: a device to produce low temperature (~1eV) high density plasmas (HDP).
- *Inductively coupled plasma (ICP)*: similar to a CCP and with similar applications but the electrode consists of a coil wrapped around the chamber where plasma is formed.^[53]
- *Wave heated plasma*: similar to CCP and ICP in that it is typically RF (or microwave). Examples include helicon discharge and electron cyclotron resonance (ECR).^[54]

Atmospheric pressure

- *Arc discharge*: this is a high power thermal discharge of very high temperature (~10,000 K). It can be generated using various power supplies. It is commonly used in metallurgical processes. For example, it is used to smelt minerals containing Al₂O₃ to produce aluminium.
- *Corona discharge*: this is a non-thermal discharge generated by the application of high voltage to sharp electrode tips. It is commonly used in ozone generators and particle precipitators.
- *Dielectric barrier discharge (DBD)*: this is a non-thermal discharge generated by the application of high voltages across small gaps wherein a non-conducting coating prevents the transition of the plasma discharge into an arc. It is often mislabeled 'Corona' discharge in industry and has similar application to corona discharges. It is also widely used in the web treatment of fabrics.^[55] The application of the discharge to synthetic fabrics and plastics functionalizes the surface and allows for paints, glues and similar materials to adhere.^[56]
- *Capacitive discharge*: this is a nonthermal plasma generated by the application of RF power (e.g., 13.56 MHz) to one powered electrode, with a grounded electrode held at a small separation distance on the order of 1 cm. Such discharges are commonly stabilized using a noble gas such as helium or argon.^[57]
- "Piezoelectric direct discharge plasma:" is a nonthermal plasma generated at the high-side of a piezoelectric transformer (PT). This generation variant is particularly suited for high efficient and compact devices where a separate high voltage power supply is not desired.

14.6 History

Plasma was first identified in a Crookes tube, and so described by Sir William Crookes in 1879 (he called

it “radiant matter”).^[58] The nature of the Crookes tube “cathode ray” matter was subsequently identified by British physicist Sir J.J. Thomson in 1897.^[59] The term “plasma” was coined by Irving Langmuir in 1928,^[60] perhaps because the glowing discharge molds itself to the shape of the Crookes tube (Gr. πλάσμα – a thing moulded or formed).^[61] Langmuir described his observations as:

Except near the electrodes, where there are *sheaths* containing very few electrons, the ionized gas contains ions and electrons in about equal numbers so that the resultant space charge is very small. We shall use the name *plasma* to describe this region containing balanced charges of ions and electrons.^[60]

14.7 Fields of active research

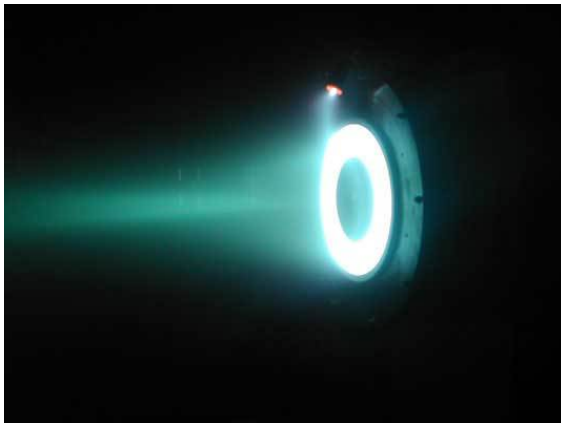

Hall effect thruster. The electric field in a plasma double layer is so effective at accelerating ions that electric fields are used in ion drives.

This is just a partial list of topics. See list of plasma (physics) articles. A more complete and organized list can be found on web sites on plasma science and technology.^[62]

14.8 See also

- Plasma torch
- Ambipolar diffusion
- Hannes Alfvén Prize
- Plasma channel
- Plasma parameters
- Plasma nitriding
- Magnetohydrodynamics (MHD)

- Electric field screening
- List of plasma physicists
- List of plasma (physics) articles
- Important publications in plasma physics
- IEEE Nuclear and Plasma Sciences Society
- Quark-gluon plasma
- Nikola Tesla
- Space physics
- Total electron content

14.9 Notes

- [1] The material undergoes various ‘regimes’ or stages (e.g. saturation, breakdown, glow, transition and thermal arc) as the voltage is increased under the voltage-current relationship. The voltage rises to its maximum value in the saturation stage, and thereafter it undergoes fluctuations of the various stages; while the current progressively increases throughout.^[46]
- [2] Across literature, there appears to be no strict definition on where the boundary is between a gas and plasma. Nevertheless, it is enough to say that at 2,000°C the gas molecules become atomized, and ionized at 3,000 °C and “in this state, [the] gas has a liquid like viscosity at atmospheric pressure and the free electric charges confer relatively high electrical conductivities that can approach those of metals.”^[47]
- [3] Note that non-thermal, or non-equilibrium plasmas are not as ionized and have lower energy densities, and thus the temperature is not dispersed evenly among the particles, where some heavy ones remain ‘cold’.

14.10 References

- [1] πλάσμα, Henry George Liddell, Robert Scott, *A Greek-English Lexicon*, on Perseus
- [2] Luo, Q-Z; D’Angelo, N; Merlino, R. L. (1998). “Shock formation in a negative ion plasma” (PDF) **5** (8). Department of Physics and Astronomy. Retrieved 2011-11-20.
- [3] Sturrock, Peter A. (1994). *Plasma Physics: An Introduction to the Theory of Astrophysical, Geophysical & Laboratory Plasmas*. Cambridge University Press. ISBN 978-0-521-44810-9.
- [4] “Ionization and Plasmas”. The University of Tennessee, Knoxville Department of Physics and Astronomy.
- [5] “How Lightning Works”. HowStuffWorks.
- [6] Plasma fountain Source, press release: Solar Wind Squeezes Some of Earth’s Atmosphere into Space

- [7] Hazeltine, R.D.; Waelbroeck, F.L. (2004). *The Framework of Plasma Physics*. Westview Press. ISBN 978-0-7382-0047-7.
- [8] Dendy, R. O. (1990). *Plasma Dynamics*. Oxford University Press. ISBN 978-0-19-852041-2.
- [9] Hastings, Daniel & Garrett, Henry (2000). *Spacecraft-Environment Interactions*. Cambridge University Press. ISBN 978-0-521-47128-2.
- [10] Peratt, A. L. (1996). "Advances in Numerical Modeling of Astrophysical and Space Plasmas". *Astrophysics and Space Science* **242** (1–2): 93–163. Bibcode:1996Ap&SS.242...93P. doi:10.1007/BF00645112.
- [11] See The Nonneutral Plasma Group at the University of California, San Diego
- [12] Nicholson, Dwight R. (1983). *Introduction to Plasma Theory*. John Wiley & Sons. ISBN 978-0-471-09045-8.
- [13] See Flashes in the Sky: Earth's Gamma-Ray Bursts Triggered by Lightning
- [14] Richard Fitzpatrick, *Introduction to Plasma Physics, Magnetized plasmas*
- [15] Yaffa Eliezer, Shalom Eliezer, *The Fourth State of Matter: An Introduction to the Physics of Plasma*, Publisher: Adam Hilger, 1989, ISBN 978-0-85274-164-1, 226 pages, page 5
- [16] Bittencourt, J.A. (2004). *Fundamentals of Plasma Physics*. Springer. p. 1. ISBN 9780387209753.
- [17] Hong, Alice (2000). "Dielectric Strength of Air". *The Physics Factbook*.
- [18] It is often stated that more than 99% of the material in the visible universe is plasma. See, for example, Gurnett, D. A. & Bhattacharjee, A. (2005). *Introduction to Plasma Physics: With Space and Laboratory Applications*. Cambridge, UK: Cambridge University Press. p. 2. ISBN 978-0-521-36483-6. and Scherer, K; Fichtner, H & Heber, B (2005). *Space Weather: The Physics Behind a Slogan*. Berlin: Springer. p. 138. ISBN 978-3-540-22907-0..
- [19] Alfvén, Hannes (1937). "Cosmic Radiation as an Intragalactic Phenomenon". *Ark. f. mat., astr. o. fys.* **25B**: 29.
- [20] Hannes, A (1990). "Cosmology in the Plasma Universe: An Introductory Exposition". *IEEE Transactions on Plasma Science* **18**: 5–10. Bibcode:1990ITPS...18....5P. doi:10.1109/27.45495. ISSN 0093-3813.
- [21] Mészáros, Péter (2010) *The High Energy Universe: Ultra-High Energy Events in Astrophysics and Cosmology*, Publisher Cambridge University Press, ISBN 978-0-521-51700-3, p. 99.
- [22] Raine, Derek J. and Thomas, Edwin George (2010) *Black Holes: An Introduction*, Publisher: Imperial College Press, ISBN 978-1-84816-382-9, p. 160
- [23] Nemiroff, Robert and Bonnell, Jerry (11 December 2004) Astronomy Picture of the Day, nasa.gov
- [24] IPPEX Glossary of Fusion Terms. Ippex.pppl.gov. Retrieved on 2011-11-19.
- [25] "Plasma and Flames – The Burning Question", from the Coalition for Plasma Science, retrieved 8 November 2012
- [26] von Engel, A. and Cozens, J.R. (1976) "Flame Plasma" in *Advances in electronics and electron physics*, L. L. Marton (ed.), Academic Press, ISBN 978-0-12-014520-1, p. 99
- [27] Dickel, J. R. (1990). "The Filaments in Supernova Remnants: Sheets, Strings, Ribbons, or?". *Bulletin of the American Astronomical Society* **22**: 832. Bibcode:1990BAAS...22..832D.
- [28] Grydeland, T. (2003). "Interferometric observations of filamentary structures associated with plasma instability in the auroral ionosphere". *Geophysical Research Letters* **30** (6). doi:10.1029/2002GL016362.
- [29] Moss, G. D.; Pasko, V. P.; Liu, N.; Veronis, G. (2006). "Monte Carlo model for analysis of thermal runaway electrons in streamer tips in transient luminous events and streamer zones of lightning leaders". *Journal of Geophysical Research* **111**. doi:10.1029/2005JA011350.
- [30] Doherty, Lowell R.; Menzel, Donald H. (1965). "Filamentary Structure in Solar Prominences". *The Astrophysical Journal* **141**: 251. Bibcode:1965ApJ...141..251D. doi:10.1086/148107.
- [31] Hubble views the Crab Nebula M1: The Crab Nebula Filaments at the Wayback Machine (archived 5 October 2009). The University of Arizona
- [32] Zhang, Y. A.; Song, M. T.; Ji, H. S. (2002). "A rope-shaped solar filament and a IIIb flare". *Chinese Astronomy and Astrophysics* **26** (4): 442. doi:10.1016/S0275-1062(02)00095-4.
- [33] Boeuf, J. P.; Chaudhury, B.; Zhu, G. Q. (2010). "Theory and Modeling of Self-Organization and Propagation of Filamentary Plasma Arrays in Microwave Breakdown at Atmospheric Pressure". *Physical Review Letters* **104**. doi:10.1103/PhysRevLett.104.015002.
- [34] Chin, S. L. (2006). "Some Fundamental Concepts of Femtosecond Laser Filamentation" (PDF). *Journal of the Korean Physical Society* **49**: 281.
- [35] Talebpour, A.; Abdel-Fattah, M.; Chin, S. L. (2000). "Focusing limits of intense ultrafast laser pulses in a high pressure gas: Road to new spectroscopic source". *Optics Communications* **183** (5–6): 479. doi:10.1016/S0030-4018(00)00903-2.
- [36] Alfvén, Hannes (1981). "section VI.13.1. Cellular Structure of Space". *Cosmic Plasma*. Dordrecht. ISBN 978-90-277-1151-9.
- [37] National Research Council (U.S.). Plasma 2010 Committee (2007). *Plasma science: advancing knowledge in the national interest*. National Academies Press. pp. 190–193. ISBN 978-0-309-10943-7.

- [38] Greaves, R. G.; Tinkle, M. D.; Surko, C. M. (1994). “Creation and uses of positron plasmas”. *Physics of Plasmas* **1** (5): 1439. doi:10.1063/1.870693.
- [39] Morfill, G. E.; Ivlev, Alexei V. (2009). “Complex plasmas: An interdisciplinary research field”. *Review of Modern Physics* **81** (4): 1353–1404. Bibcode:2009RvMP...81.1353M. doi:10.1103/RevModPhys.81.1353.
- [40] Alfvén, H.; Smårs, E. (1960). “Gas-Insulation of a Hot Plasma”. *Nature* **188** (4753): 801–802. Bibcode:1960Natur.188..801A. doi:10.1038/188801a0.
- [41] Braams, C.M. (1966). “Stability of Plasma Confined by a Cold-Gas Blanket”. *Physical Review Letters* **17** (9): 470–471. Bibcode:1966PhRvL..17..470B. doi:10.1103/PhysRevLett.17.470.
- [42] Yaghoubi, A.; Mélinon, P. (2013). “Tunable synthesis and in situ growth of silicon-carbon mesostructures using impermeable plasma”. *Scientific Reports* **3**. Bibcode:2013NatSR...3E1083Y. doi:10.1038/srep01083. PMC 3547321. PMID 23330064.
- [43] See *Evolution of the Solar System, 1976*
- [44] Hippler, R.; Kersten, H.; Schmidt, M.; Schoenbach, K.M., eds. (2008). “Plasma Sources”. *Low Temperature Plasmas: Fundamentals, Technologies, and Techniques* (2nd ed.). Wiley-VCH. ISBN 978-3-527-40673-9.
- [45] Chen, Francis F. (1984). *Plasma Physics and Controlled Fusion*. Plenum Press. ISBN 978-0-306-41332-2.
- [46] Leal-Quirós, Edbertho (2004). “Plasma Processing of Municipal Solid Waste”. *Brazilian Journal of Physics* **34** (4B): 1587. Bibcode:2004BrJPh..34.1587L. doi:10.1590/S0103-97332004000800015.
- [47] Gomez, E.; Rani, D. A.; Cheeseman, C. R.; Deegan, D.; Wise, M.; Boccaccini, A. R. (2009). “Thermal plasma technology for the treatment of wastes: A critical review”. *Journal of Hazardous Materials* **161** (2–3): 614–626. doi:10.1016/j.jhazmat.2008.04.017. PMID 18499345.
- [48] National Research Council (1991). *Plasma Processing of Materials : Scientific Opportunities and Technological Challenges*. National Academies Press. ISBN 978-0-309-04597-1.
- [49] Nemchinsky, V. A.; Severance, W. S. (2006). “What we know and what we do not know about plasma arc cutting”. *Journal of Physics D: Applied Physics* **39** (22): R423. doi:10.1088/0022-3727/39/22/R01.
- [50] Peretich, M.A.; O'Brien, W.F.; Schetz, J.A. (2007). “Plasma torch power control for scramjet application” (PDF). Virginia Space Grant Consortium. Retrieved 12 April 2010.
- [51] Stern, David P. “The Fluorescent Lamp: A plasma you can use”. Retrieved 2010-05-19.
- [52] Sobolewski, M.A.; Langan & Felker, J.G. & B.S. (1997). “Electrical optimization of plasma-enhanced chemical vapor deposition chamber cleaning plasmas” (PDF) **16** (1). *Journal of Vacuum Science and Technology B*. pp. 173–182. Archived from the original (PDF) on January 18, 2009.
- [53] Okumura, T. (2010). “Inductively Coupled Plasma Sources and Applications”. *Physics Research International* **2010**: 1. doi:10.1155/2010/164249.
- [54] *Plasma Chemistry*. Cambridge University Press. 2008. p. 229. ISBN 9781139471732.
- [55] Leroux, F.; Perwuelz, A.; Campagne, C.; Behary, N. (2006). “Atmospheric air-plasma treatments of polyester textile structures”. *Journal of Adhesion Science and Technology* **20** (9): 939. doi:10.1163/15685610677657788.
- [56] Leroux, F. D. R.; Campagne, C.; Perwuelz, A.; Gengembre, L. O. (2008). “Polypropylene film chemical and physical modifications by dielectric barrier discharge plasma treatment at atmospheric pressure”. *Journal of Colloid and Interface Science* **328** (2): 412–420. doi:10.1016/j.jcis.2008.09.062. PMID 18930244.
- [57] Park, J.; Henins, I.; Herrmann, H. W.; Selwyn, G. S.; Hicks, R. F. (2001). “Discharge phenomena of an atmospheric pressure radio-frequency capacitive plasma source”. *Journal of Applied Physics* **89**: 20. doi:10.1063/1.1323753.
- [58] Crookes presented a lecture to the British Association for the Advancement of Science, in Sheffield, on Friday, 22 August 1879
- [59] Announced in his evening lecture to the Royal Institution on Friday, 30 April 1897, and published in “J. J. Thomson (1856–1940)”. *Philosophical Magazine* **44**: 293. 1897. doi:10.1080/14786449708621070.
- [60] Langmuir, I. (1928). “Oscillations in Ionized Gases”. *Proceedings of the National Academy of Sciences* **14** (8): 627. doi:10.1073/pnas.14.8.627.
- [61] Brown, Sanborn C. (1978). “Chapter 1: A Short History of Gaseous Electronics”. In HIRSH, Merle N. e OSKAM, H. J. *Gaseous Electronics* **1**. Academic Press. ISBN 978-0-12-349701-7.
- [62] Web site for Plasma science and technology
- [63] “High-tech dentistry – “St Elmo’s frier” – Using a plasma torch to clean your teeth”. The Economist print edition. Jun 17, 2009. Retrieved 2009-09-07.

14.11 External links

- Free plasma physics books and notes
- Plasmas: the Fourth State of Matter
- Plasma Science and Technology
- Plasma on the Internet – a list of plasma related links.

- Introduction to Plasma Physics: Graduate course given by Richard Fitzpatrick|M.I.T. Introduction by I.H.Hutchinson
- Plasma Material Interaction
- How to make a glowing ball of plasma in your microwave with a grape|More (Video)
- How to make plasma in your microwave with only one match (video)
- OpenPIC3D – 3D Hybrid Particle-In-Cell simulation of plasma dynamics
- Plasma Formulary Interactive

Chapter 15

Compact fluorescent lamp

“Low-energy light-bulb” redirects here. For other low-energy bulbs, see LED lamp.

A **compact fluorescent lamp** (CFL), also called **com-**



The tubular-type compact fluorescent lamp is one of the most popular types in Europe

compact fluorescent light, **energy-saving light**, and **compact fluorescent tube**, is a fluorescent lamp designed to replace an incandescent lamp; some types fit into light fixtures formerly used for incandescent lamps. The lamps use a tube which is curved or folded to fit into the space of an incandescent bulb, and a compact electronic ballast in the base of the lamp.

Compared to general-service incandescent lamps giving the same amount of visible light, CFLs use one-fifth to one-third the electric power, and last eight to fifteen times longer. A CFL has a higher purchase price than an incandescent lamp, but can save over five times its purchase price in electricity costs over the lamp's lifetime.^[1] Like all fluorescent lamps, CFLs contain toxic mercury^[2] which complicates their disposal. In many countries, governments have established recycling schemes for CFLs and glass generally.

The principle of operation in a CFL bulb remains the same as in other fluorescent lighting: electrons that are bound to mercury atoms are excited to states where they will radiate ultraviolet light as they return to a lower energy level; this emitted ultraviolet light is converted into visible light as it strikes the fluorescent coating on the bulb (as well as into heat when absorbed by other materials



Compact fluorescent light bulb with GU24 connector

such as glass).

CFLs radiate a spectral power distribution that is different from that of incandescent lamps. Improved phosphor formulations have improved the perceived color of the light emitted by CFLs, such that some sources rate the best “soft white” CFLs as subjectively similar in color to standard incandescent lamps.^[3]

White LED lamps now compete with CFLs for high-efficiency house lighting.^[4]



Comparison of compact fluorescent light bulbs with 105 W, 36 W, and 11 W power consumption

15.1 History

The parent to the modern fluorescent lamp was invented in the late 1890s by Peter Cooper Hewitt.^[5] The Cooper Hewitt lamps were used for photographic studios and industries.^[5]

Edmund Germer, Friedrich Meyer, and Hans Spanner patented a high-pressure vapor lamp in 1927.^[5] George Inman later teamed with General Electric to create a practical fluorescent lamp, sold in 1938 and patented in 1941.^[5] Circular and U-shaped lamps were devised to reduce the length of fluorescent light fixtures. The first fluorescent bulb and fixture were displayed to the general public at the 1939 New York World's Fair.

The spiral CFL was invented in 1976 by Edward E. Hammer, an engineer with General Electric,^[6] in response to the 1973 oil crisis.^[7] Although the design met its goals, it would have cost GE about \$25 million to build new factories to produce the lamps, and thus the invention was shelved.^[8] The design eventually was copied by others.^[8] In 1995, helical CFLs, manufactured in China, became commercially available.^[9] Since that time, their sales have steadily increased.

In 1980, Philips introduced its model SL, which was a screw-in lamp with integral magnetic ballast. The lamp used a folded T4 tube, stable tri-color phosphors, and a mercury amalgam. This was the first successful screw-in replacement for an incandescent lamp. In 1985, Osram started selling its model EL lamp, which was the first CFL to include an electronic ballast.^[10]

Development of fluorescent lamps that could fit in the same volume as comparable incandescent lamps required the development of new, high-efficacy phosphors that could withstand more power per unit area than the phos-

phors used in older, larger fluorescent tubes.^[10]

- Philips SL, an early CFL
- A helical integrated CFL, one of the most popular designs in North America, since 1995, when a Chinese firm, Shanghai Xiangshan, marketed the first successful design.^[1]

1. ^ Cite error: The named reference lamptech was invoked but never defined (see the help page).

15.2 Design

There are two types of CFLs: integrated and non-integrated lamps. Integrated lamps combine the tube and ballast in a single unit. These lamps allow consumers to replace incandescent lamps easily with CFLs. Integrated CFLs work well in many standard incandescent light fixtures, reducing the cost of converting to fluorescent. 3-way lamp bulbs and dimmable models with standard bases are available.

Non-integrated CFLs have the ballast permanently installed in the luminaire, and only the lamp bulb is usually changed at its end of life. Since the ballasts are placed in the light fixture, they are larger and last longer compared to the integrated ones, and they don't need to be replaced when the bulb reaches its end-of-life. Non-integrated CFL housings can be both more expensive and sophisticated. They have two types of tubes: a bi-pin tube designed for conventional ballast, and a quad-pin tube designed for an electronic ballast or a conventional ballast with an external starter. A bi-pin tube contains an integrated starter, which obviates the need for external heating pins but causes incompatibility with electronic ballasts.



Non-integrated bi-pin double-turn CFL

CFLs have two main components: a magnetic or electronic ballast and a gas-filled tube (also called bulb or burner). Replacement of magnetic ballasts with electronic ballasts has removed most of the flickering and

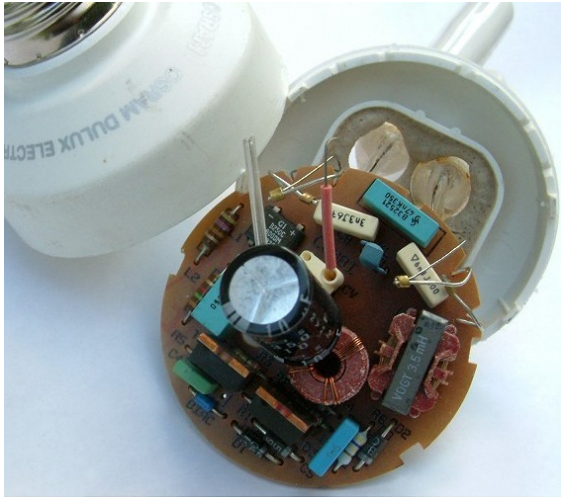

An electronic ballast and permanently attached tube in an integrated CFL

slow starting traditionally associated with fluorescent lighting, and has allowed the development of smaller lamps directly interchangeable with more sizes of incandescent bulb.

Electronic ballasts contain a small circuit board with rectifiers, a filter capacitor and usually two switching transistors. The incoming AC current is first rectified to DC, then converted to high frequency AC by the transistors, connected as a resonant series DC to AC inverter. The resulting high frequency is applied to the lamp tube. Since the resonant converter tends to stabilize lamp current (and light produced) over a range of input voltages, standard CFLs do not respond well in dimming applications. Special electronic ballasts (integrated or separate) are required for dimming service.

CFL light output is roughly proportional to phosphor surface area, and high output CFLs are often larger than their incandescent equivalents. This means that the CFL may not fit well in existing light fixtures. To fit enough phosphor coated area within the approximate overall dimensions of an incandescent lamp, standard shapes of CFL tube are a helix with one or more turns, multiple parallel tubes, circular arc, or a butterfly.

Some CFLs are labeled not to be run base up, since heat will shorten the ballast's life. Such CFLs are unsuitable for use in pendant lamps and especially unsuitable for recessed light fixtures. CFLs for use in such fixtures are available.^[11] Current recommendations for fully enclosed, unventilated light fixtures (such as those recessed into insulated ceilings), are either to use "reflector CFLs" (R-CFL),^{[12][13]} cold-cathode CFLs or to replace such fixtures with those designed for CFLs.^[12] A CFL will thrive in areas that have good airflow, such as in a table lamp.^[14]

15.3 Characteristics

15.3.1 Spectrum of light

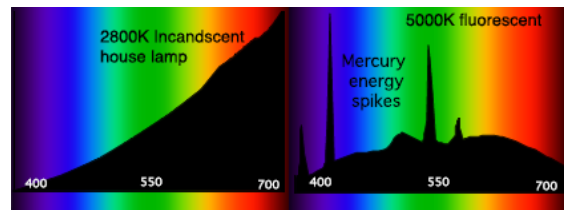

Characteristic spectral power distributions (SPDs) for an incandescent lamp (left) and a CFL (right). The horizontal axes are in nanometers and the vertical axes show relative intensity in arbitrary units

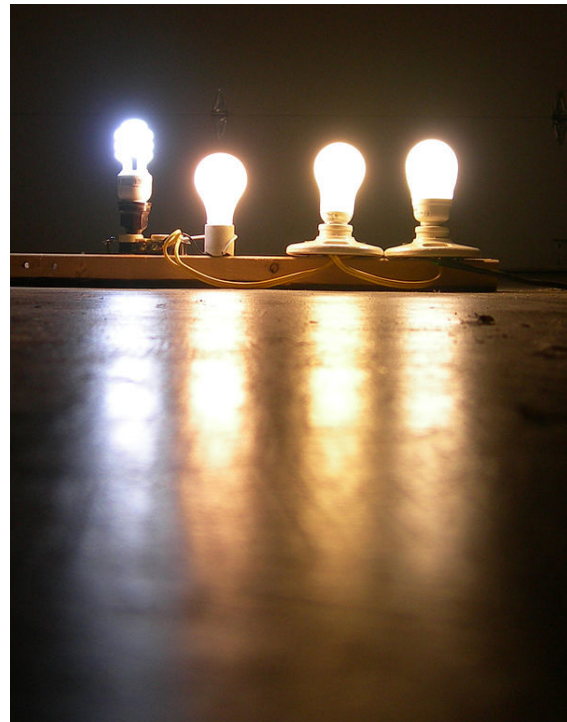

A photograph of various lamps illustrates the effect of color temperature differences. From left to right:— Compact Fluorescent: General Electric, 13 W, 6,500 K; Incandescent: Sylvania 60 W Extra Soft White; Compact Fluorescent: Bright Effects, 15 W, 2,644 K; Compact Fluorescent: Sylvania, 14 W, 3,000 K

CFLs emit light from a mix of phosphors inside the bulb, each emitting one band of color. Modern phosphor designs balance the emitted light color, energy efficiency, and cost. Every extra phosphor added to the coating mix improves color rendering but decreases efficiency and increases cost. Good quality consumer CFLs use three or four phosphors to achieve a "white" light with a color rendering index (CRI) of about 80, where the maximum 100 represents the appearance of colors under daylight or a black-body (depending on the correlated color temperature).

Color temperature can be indicated in kelvins or mireds (1 million divided by the color temperature in kelvins). The color temperature of a light source is the temperature

of a black body that has the same chromaticity (i.e. color) of the light source. A notional temperature, the correlated color temperature, the temperature of a black body which emits light of a hue which to human color perception most closely matches the light from the lamp, is assigned.

A true color temperature is characteristic of black-body radiation; a fluorescent lamp may approximate the radiation of a black body at a given temperature, but will not have an identical spectrum. In particular, narrow bands of shorter-wavelength radiation are usually present even for lamps of low color temperature (“warm” light).^[15]

As color temperature increases, the shading of the white light changes from red to yellow to white to blue. Color names used for modern CFLs and other tri-phosphor lamps vary between manufacturers, unlike the standardized names used with older halophosphate fluorescent lamps. For example, Sylvania’s Daylight CFLs have a color temperature of 3,500 K, while most other lamps called *daylight* have color temperatures of at least 5,000 K.

15.3.2 Lifespan

CFLs typically have a rated service life of 6,000–15,000 hours, whereas standard incandescent lamps have a service life of 750 or 1,000 hours.^{[16][17][18]} However, the actual lifetime of any lamp depends on many factors, including operating voltage, manufacturing defects, exposure to voltage spikes, mechanical shock, frequency of cycling on and off, lamp orientation, and ambient operating temperature, among other factors.^[19]

The life of a CFL is significantly shorter if it is turned on and off frequently. In the case of a 5-minute on/off cycle the lifespan of some CFLs may be reduced to that of incandescent light bulbs. The U.S. Energy Star program suggests that fluorescent lamps be left on when leaving a room for less than 15 minutes to mitigate this problem.^[20] CFLs produce less light later in their lives than when they are new. The light output decay is exponential, with the fastest losses being soon after the lamp is first used. By the end of their lives, CFLs can be expected to produce 70–80% of their original light output.^[21] The response of the human eye to light is logarithmic. That is, while the human eye is highly sensitive to changes in the intensity of faint light sources, it is less sensitive to changes in the intensity of brighter light sources since the pupils compensate by dilating or constricting.^[22] So, presuming the illumination provided by the lamp was ample at the beginning of its life, and the light output of a bulb gradually decreases by 25%, viewers will perceive a much smaller change in light intensity.^[23]

Fluorescent lamps get dimmer over their lifetime,^[24] so what starts out as an adequate luminosity may become inadequate. In one test by the U.S. Department of Energy of “Energy Star” products in 2003–04, one quarter of tested CFLs no longer met their rated output after 40%

of their rated service life.^{[25][26]}

15.3.3 Energy efficiency

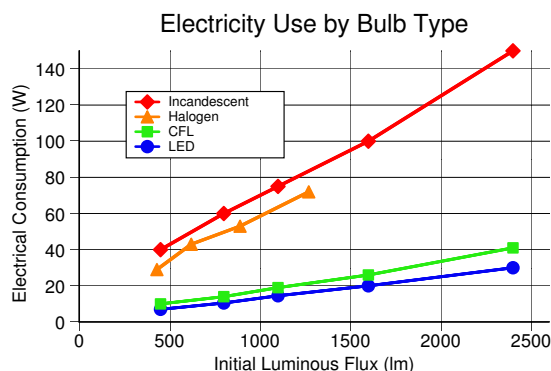

Energy usage for different types of light bulbs operating at different light outputs. Points lower on the graph correspond to lower energy use

For more details on this topic, see Luminous efficacy.

Because the eye’s sensitivity changes with the wavelength, the output of lamps is commonly measured in lumens, a measure of the power of light as perceived by the human eye. The luminous efficacy of lamps is the number of lumens produced for each watt of electrical power used. The luminous efficacy of a typical CFL is 50–70 lumens per watt (lm/W) and that of a typical incandescent lamp is 10–17 lm/W.^[27] Compared to a theoretical 100%-efficient lamp (680 lm/W), CFL lamps have lighting efficiency ranges of 7–10%,^[28] versus 1.5–2.5%^[29] for incandescents.^[30]

Because of their higher efficacy, CFLs use between one-seventh and one-third of the power of equivalent incandescent lamps.^[27] Fifty to seventy percent of the world’s total lighting market sales were incandescent in 2010.^[31] Replacing all inefficient lighting with CFLs would save 409 terawatt hours (TWh) per year, 2.5% of the world’s electricity consumption. In the US, it is estimated that replacing all the incandescents would save 80 TWh yearly.^[32] Since CFLs use much less energy than incandescent lamps (ILs), a phase-out of ILs would result in less carbon dioxide (CO₂) being emitted into the atmosphere. Exchanging ILs for efficient CFLs on a global scale would achieve annual CO₂ reductions of 230 Mt (million tons), more than the combined yearly CO₂ emissions of the Netherlands and Portugal.^[33]

If a building’s indoor incandescent lamps are replaced by CFLs, the heat produced due to lighting is significantly reduced. In warm climates or in office or industrial buildings where air conditioning is often required, CFLs reduce the load on the cooling system when compared to the use of incandescent lamps, resulting in savings in electricity in addition to the energy efficiency sav-

ings of the lamps themselves. However in cooler climates in which buildings require heating, the heating system needs to replace the reduced heat from lighting fixtures. In Winnipeg, Canada, it was estimated that CFLs would only generate 17% savings in energy compared to incandescent bulbs, as opposed to the 75% savings that could have been expected without space heating considerations.^[36]

15.3.4 Cost

While the purchase price of a CFL is typically 3–10 times greater than that of an equivalent incandescent lamp, a CFL lasts 8–15 times longer and uses two-thirds to three-quarters less energy. A U.S. article stated “A household that invested \$90 in changing 30 fixtures to CFLs would save \$440 to \$1,500 over the five-year life of the bulbs, depending on your cost of electricity. Look at your utility bill and imagine a 12% discount to estimate the savings.”^[37]

CFLs are extremely cost-effective in commercial buildings when used to replace incandescent lamps. Using average U.S. commercial electricity and gas rates for 2006, a 2008 article found that replacing each 75 W incandescent lamp with a CFL resulted in yearly savings of \$22 in energy usage, reduced HVAC cost, and reduced labour to change lamps. The incremental capital investment of \$2 per fixture is typically paid back in about one month. Savings are greater and payback periods shorter in regions with higher electric rates and, to a lesser extent, also in regions with higher than U.S. average cooling requirements.^[38] However, frequent on-off cycling (turning on and off) of CFLs greatly reduces their lifespan. CFLs should be avoided in places where lights are frequently turned on and off, as it would increase costs and add to e-waste generation.

The current price of CFLs reflects the manufacturing of nearly all CFLs in China, where labour costs less. In September 2010, the Winchester, Virginia, General Electric plant closed,^[39] leaving Osram Sylvania and the tiny American Light Bulb Manufacturing Inc. the last companies to make standard incandescent bulbs in the United States.^[40] At that time, Ellis Yan, whose Chinese company made the majority of CFLs sold in the United States, said he was interested in building a United States factory to make CFL bulbs, but wanted \$12.5 million from the U.S. government to do so. General Electric had considered changing one of its bulb plants to make CFLs, but said that even after a \$40 million investment in converting a plant, wage differences would mean costs would be 50% higher.^[39]

According to an August 2009 newspaper report, some manufacturers claimed that CFLs could be used to replace higher-power incandescent lamps than justified by their light output.^[41] Equivalent wattage claims can be replaced by comparison of actual light output produced by

the lamp, which is measured in lumens and marked on the packaging.^[42]



compact fluorescent lamp with holder wall mounted

15.3.5 Failure

In addition to the wear-out failure modes common to all fluorescent lamps, the electronic ballast may fail, since it has a number of component parts. Ballast failures may be accompanied by discoloration or distortion of the ballast enclosure, odors, or smoke.^[43] The lamps are internally protected and are meant to fail safely at the end of their lives. Industry associations are working toward advising consumers of the different failure modes of CFLs compared to incandescent lamps, and to develop lamps with inoffensive failure modes.^[44] New North American technical standards aim to eliminate smoke or excess heat at the end of lamp life.^[45]

15.3.6 Dimming

Only some compact fluorescent lamps are labeled for dimming control. Using a dimmer with a standard CFL



Dimmable integrated helical CFL that dims 2–100%, comparable to standard light bulb dimming properties

is ineffective and can shorten bulb life and void the warranty.^{[46][47]} Dimmable CFLs are available. The dimmer switch used in conjunction with a dimmable CFL must be matched to its power consumption range;^[48] many dimmers installed for use with incandescent bulbs do not function acceptably below 40 W, whereas CFL applications commonly draw power in the range 7–20 W. Dimmable CFLs have been marketed before suitable dimmers are available. The dimming range of CFLs is usually between 20% and 90%,^[49] but many modern CFLs have a dimmable range of 2% to 100%, more akin to that of incandescent lights. There are two types of dimmable CFL on the market: Standard dimmable CFLs, and “switch-dimmable” CFLs. The latter use a standard light switch, and the on-board electronics chooses the light output level based on the number of times the switch is turned on and off quickly. Dimmable CFLs are not a 100% replacement for incandescent fixtures that are dimmed for “mood scenes” such as wall sconces in a dining area. Below the 20% limit, the lamp may remain at 20% or flicker or the starter circuitry may stop and restart.^[50] Above 80%, the bulb may operate at

100%. However, recent products have solved these problems so that they perform more like incandescent lamps. Dimmable CFLs are more expensive than standard CFLs due to the additional circuitry.

Cold-cathode CFLs can be dimmed to low levels, making them popular replacements for incandescent bulbs on dimmer circuits.

When a CFL is dimmed, its color temperature (warmth) stays the same. This is counter to most other light sources (such as the sun or incandescents) where color gets redder as the light source gets dimmer. The *Kruithof curve* from 1934 described an empirical relationship between intensity and color temperature of visually pleasing light sources.

15.3.7 Power factor

The input stage of a CFL is a rectifier, which presents a non-linear load to the power supply and introduces harmonic distortion on the current drawn from the supply.^{[51][52]} The use of CFLs in homes has no appreciable effect on power quality, but significant quantities of them in a large facility can have an impact. The power factor of CFLs does not significantly affect their energy-saving benefits for individual consumers, but their use in large numbers—such as in commercial applications or across millions of homes in a distribution system—could require infrastructure upgrades. In such cases, CFLs with low (below 30 percent) total harmonic distortion (THD) and power factors greater than 0.9 should be selected.^{[53][54][55]}

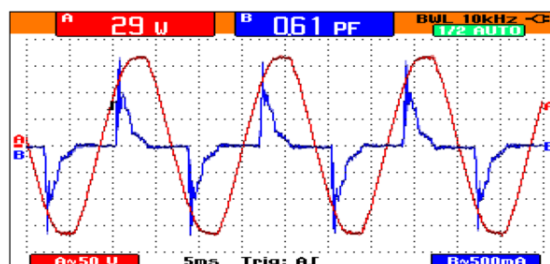

Voltage and current for a 120 V 60 Hz 30-watt compact fluorescent lamp. Because the current is heavily distorted, the power factor of this lamp is only 0.61. The lamp takes 29 watts but 39 volt-amperes due to this distortion.

15.3.8 Infrared signals

Electronic devices operated by infrared remote control can interpret the infrared light emitted by CFLs as a signal; this may limit the use of CFLs near televisions, radios, remote controls, or mobile phones. Energy Star certified CFLs must meet FCC standards, and so are required to list all known incompatibilities on the package.^{[56][57]}

15.3.9 Outdoor use



A CFL used outside of a building

CFLs are generally not designed for outdoor use and some will not start in cold weather. CFLs are available with cold-weather ballasts, which may be rated to as low as $-28.8\text{ }^{\circ}\text{C}$ ($-20\text{ }^{\circ}\text{F}$).^[58] Light output in the first few minutes drops at low temperatures.^[59] Cold-cathode CFLs will start and perform in a wide range of temperatures due to their different design.

15.3.10 Starting time

Incandescents reach full brightness a fraction of a second after being switched on. As of 2009, CFLs turn on within a second, but many still take time to achieve full brightness.^[60] The light color may be slightly different immediately after being turned on.^[61] Some CFLs are marketed as “instant on” and have no noticeable warm-up period,^[62] but others can take up to a minute to reach full brightness,^[63] or longer in very cold temperatures. Some that use a mercury amalgam can take up to three minutes to reach full output.^[62] This and the shorter life of CFLs when turned on and off for short periods may make CFLs less suitable for applications such as motion-activated lighting. Hybrid lamps, combining a halogen lamp with a CFL, are available where warm up time is unacceptable.^{[64][65]} The halogen lamp lights immediately, and is switched off once the CFL has reached full brightness.

15.4 Health and environmental impact

Main article: [Fluorescent lamps and health](#)



Closed double-envelope CFL

15.4.1 General

According to the European Commission Scientific Committee on Emerging and Newly Identified Health Risks (SCENIHR) in 2008, CFLs may pose an added health risk due to the ultraviolet and blue light emitted. This radiation could aggravate symptoms in people who already suffer skin conditions that make them exceptionally sensitive to light. The light produced by some single-envelope CFLs at distances of less than 20 cm (7.9 in) could lead to ultraviolet exposures approaching the current workplace limit set to protect workers from skin and retinal damage. However, industry sources claim the UV radiation received from CFLs is too small to contribute to skin cancer and the use of double-envelope CFLs “largely or entirely” mitigates any other risks.^[66]

Tests have shown that radiation exposure from CFLs is negligible at 150 centimeter distance from the source. At closer distances, comparisons show that CFLs emit less UVA (long wavelength) radiation than incandescent light bulbs. They do, however, emit higher levels of UVB (short wavelength) radiation.^[67] UVA can penetrate deep into the skin while sufficient levels of UVB can burn superficial layers. Closed (double-envelope) CFLs are shielded and emit a lower total UV radiation compared

to incandescent or halogen bulbs of a similar wattage.

For the average user, UV radiation from indoor lights does not appear to be a concern. For those with skin sensitivity long term indoor exposure may be a concern, in which case they may want to use a bulb with lower UV radiation output. There seems to be more variability within bulb types than between them, but the best option is shielded CFLs.

A 2012 study comparing cellular health effects of CFL light and incandescent light found statistically significant cell damage in cultures exposed to CFL light. Spectroscopic analysis confirmed the presence of significant UVA and UVC radiation, which the study's authors conjectured was attributable to damage in the bulbs' internal phosphor coatings. No cellular damage was observed following exposure to incandescent light of equivalent intensity. The study's authors suggest that the ultraviolet exposure could be limited by the use of "double-walled" bulbs manufactured with an additional glass covering surrounding the phosphor-coated layer.^[68]

When the base of the bulb is not made to be flame-retardant, as required in the voluntary standard for CFLs, overheating of the electrical components in the bulb may create a fire hazard.^[69]

15.4.2 Mercury content

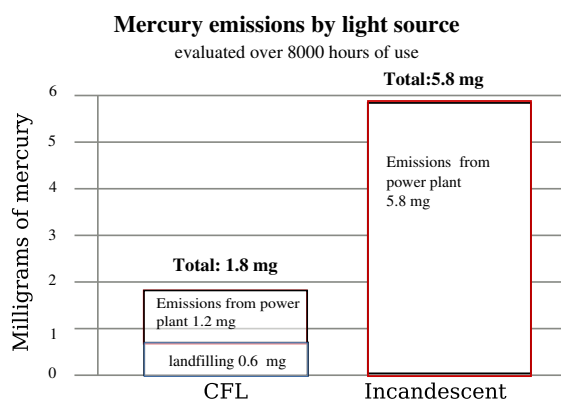

Net mercury emissions for CFL and incandescent lamps, based on EPA FAQ sheet, assuming average U.S. emission of 0.012 mg of mercury per kilowatt-hour and 14% of CFL mercury contents escapes to environment after land fill disposal

CFLs, like all fluorescent lamps, contain mercury^{[70][71]} as vapor inside the glass tubing. Most CFLs contain 3–5 mg per bulb, with the bulbs labeled “eco-friendly” containing as little as 1 mg.^{[72][73]} Because mercury is poisonous, even these small amounts are a concern for landfills and waste incinerators where the mercury from lamps may be released and contribute to air and water pollution. In the U.S., lighting manufacturer members of the National Electrical Manufacturers Association (NEMA) have voluntarily capped the amount of mercury used in CFLs.^[74] In the EU the same cap is required

by the RoHS law.

In areas with coal-fired power stations, the use of CFLs saves on mercury emissions when compared to the use of incandescent bulbs. This is due to the reduced electrical power demand, reducing in turn the amount of mercury released by coal as it is burned.^[75] In July 2008 the U.S. EPA published a data sheet stating that the net system emission of mercury for CFL lighting was lower than for incandescent lighting of comparable lumen output. This was based on the average rate of mercury emission for U.S. electricity production and average estimated escape of mercury from a CFL put into a landfill.^[76] Coal-fired plants also emit other heavy metals, sulfur, and carbon dioxide.

In the United States, the U.S. Environmental Protection Agency estimated that if all 270 million CFLs sold in 2007 were sent to landfill sites, around 0.13 metric tons of mercury would be released, 0.1% of all U.S. emissions of mercury (around 104 metric tons that year).^[77] The graph assumes that CFLs last an average of 8,000 hours regardless of manufacturer and premature breakage. In areas where coal is not used to produce energy, the emissions would be less for both types of bulb.^[78]

Special handling instructions for breakage are not printed on the packaging of household CFL bulbs in many countries. The amount of mercury released by one bulb can temporarily exceed U.S. federal guidelines for chronic exposure.^{[79][80]} *Chronic*, however, implies exposure for a significant time, and it remains unclear what the health risks are from short-term exposure to low levels of elemental mercury.^[80] Despite following EPA best-practice clean-up guidelines on broken CFLs, researchers were unable to remove mercury from carpet, and agitation of the carpet — such as by young children playing — created localized concentrations as high as 0.025 mg/m³ in air close to the carpet, even weeks after the initial breakage.^[80]

The U.S. Environmental Protection Agency (EPA) has published best practices for cleanup of broken CFLs, as well as ways to avoid breakage, on its web site.^[81] It recommends airing out the room and carefully disposing of broken pieces in a jar. A Maine Department of Environmental Protection (DEP) study of 2008 comparing clean-up methods warns that using plastic bags to store broken CFL bulbs is dangerous because vapors well above safe levels continue to leak from the bags. The EPA and the Maine DEP recommend a sealed glass jar as the best repository for a broken bulb.^[82]

15.4.3 Recycling

See also: Fluorescent lamp recycling

Health and environmental concerns about mercury have prompted many jurisdictions to require spent lamps to

be properly disposed of or recycled, rather than being included in the general waste stream sent to landfills. Safe disposal requires storing the bulbs unbroken until they can be processed.

In the United States, most states have adopted and currently implement the federal Universal Waste Rule (UWR).^[83] Several states, including Vermont, New Hampshire, California, Minnesota, New York, Maine, Connecticut and Rhode Island, have regulations that are more stringent than the federal UWR.^[83] Home-supply chain stores make free CFL recycling widely available.^[84]

In the European Union, CFLs are one of many products subject to the WEEE recycling scheme. The retail price includes an amount to pay for recycling, and manufacturers and importers have an obligation to collect and recycle CFLs.

According to the Northwest Compact Fluorescent Lamp Recycling Project, because household users in the U.S. Northwest have the option of disposing of these products in the same way they dispose of other solid waste, in Oregon “a large majority of household CFLs are going to municipal solid waste”. They also note the EPA’s estimates for the percentage of fluorescent lamps’ total mercury released when they are disposed of in the following ways: municipal waste landfill 3.2%, recycling 3%, municipal waste incineration 17.55% and hazardous waste disposal 0.2%.^[85]

The first step of processing CFLs involves crushing the bulbs in a machine that uses negative pressure ventilation and a mercury-absorbing filter or cold trap to contain mercury vapor. Many municipalities are purchasing such machines. The crushed glass and metal is stored in drums, ready for shipping to recycling factories.

15.4.4 Greenhouse gases

In some places, such as Quebec and British Columbia in 2007, central heating for homes was provided mostly by the burning of natural gas, whereas electricity was primarily provided by hydroelectric power. An analysis of the impacts of a ban on incandescent light bulbs at that time introduced the notion that in such areas, heat generated by conventional electric light bulbs may have been significantly reducing the release of greenhouse gases from natural gas.^[86] Ivanco, Karney, and Waher estimated that “If all homes in Quebec were required to switch from (incandescent) bulbs to CFLs, there would be an increase of almost 220,000 tonnes in CO₂ emissions in the province, equivalent to the annual emissions from more than 40,000 automobiles.” Such calculations were based on the implicit assumption that changes in power consumption equally affect electricity generation in different types of power stations. That is, the electricity generation mix was assumed to stay unchanged. Hydroelectric and nuclear power stations, in most cases, produce baseload power, or as much electric energy as

technically possible, regardless of consumption. Therefore changes in power consumption may in reality mostly affect the amounts of electricity imported and exported, and thus the amount of power actually generated in other regions, where fossil-fuelled power plants may dominate.

15.5 Use and adoption

Main article: Phase-out of incandescent light bulbs

CFLs are produced for both alternating current (AC) and direct current (DC) input. DC CFLs are popular for use in recreational vehicles and off-the-grid housing. There are various aid agency initiatives in developing countries to replace kerosene lamps, which have associated health and safety hazards, with CFLs powered by batteries, solar panels or wind generators.^[87]

CFLs in solar powered street lights, use solar panels mounted on the pole.

Due to the potential to reduce electric consumption and pollution, various organizations have encouraged the adoption of CFLs and other efficient lighting. Efforts range from publicity to encourage awareness, to direct handouts of CFLs to the public. Some electric utilities and local governments have subsidized CFLs or provided them free to customers as a means of reducing electric demand (and so delaying additional investments in generation).

In the United States, the *Program for the Evaluation and Analysis of Residential Lighting* (PEARL) was created to be a watchdog program. PEARL has evaluated the performance and ENERGY STAR compliance of more than 150 models of CFL bulbs.^{[88][89]}

The UN Environment Programme (UNEP)/Global Environment Facility (GEF) enlighten initiative has developed “The Global Efficient Partnership Program” which focuses on country-led policies and approaches to enable the implementation of energy-efficient lighting, including CFLs, quickly and cost-effectively in developing and emerging countries.

In the United States and Canada, the Energy Star program labels lamps that meet a set of standards for efficiency, starting time, life expectancy, color, and consistency of performance. The intent of the program is to reduce consumer concerns due to variable quality of products.^[90] Those CFLs with a recent Energy Star certification start in less than one second and do not flicker. “Energy Star Light Bulbs for Consumers” is a resource for finding and comparing Energy Star qualified lamps. There is ongoing work in improving the “quality” (color rendering index) of the light.

In the United Kingdom, a similar program is run by the Energy Saving Trust to identify lighting products that meet energy conservation and performance guidelines.^[91]

The G24 (624Q2) and GU24 socket systems were designed to replace the traditional lamp sockets, so that incandescent bulbs are not installed in fixtures intended for energy efficient lamps only.

15.6 Other CFL and lighting technologies

15.6.1 LEDs

Solid-state lighting using light-emitting diodes (LEDs) have for some time filled many specialist niches such as traffic lights. White LED lights now compete with CFLs for high-efficiency house lighting.^[4]

Solid-state lighting has improved over several years; U.S. Department of Energy (DOE) tests of commercial LED lamps designed to replace incandescent or CFLs showed that average efficacy was about 30 lm/W in 2008 (tested performance ranged from 4 lm/W to 62 lm/W).^[92] In June 2011 the eight products in the A-line bulb configuration that DOE tested^[93] ranged from 50 to 97 lumens per watt, with an average of 62 lumens/watt.

The luminous efficacy of currently available LED lamps is similar that of CFLs, though there have been LED lamps available for purchase with better than 90 lm/W overall luminous efficacy at least since early 2012, and higher efficiency LEDs, up to 200 lm/W, are under development.^[94]

15.7 Cold-cathode fluorescent lamps

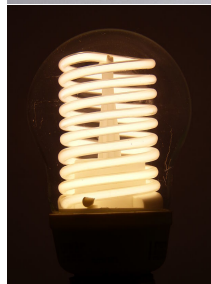

A cold-cathode CFL unlit (left) and illuminated (right)

The cold-cathode fluorescent lamp (CCFL) is a form of

CFL. CCFLs use electrodes without a filament. The voltage of CCFLs is about 5 times higher than CFLs, and the current is about 10 times lower. CCFLs have a diameter of about 3 millimeters. CCFLs were initially used for document scanners and also for back-lighting LCD displays, and later manufactured for use as lamps. The efficacy (lumens per watt) is about half that of CFLs. Their advantages are that they are instant-on, like incandescent lamps, and have a long life of approximately 50,000 hours. CCFLs are an effective and efficient replacement for lighting that is turned on and off frequently with little extended use (for example, in a bathroom or closet).

15.8 Efficiency comparison

15.9 References

- [1] "Compact Fluorescent Light Bulbs". Energy Star. Retrieved 2010-09-30.
- [2] "CFL Bulbs Have One Hitch: Toxic Mercury". National Public Radio. Retrieved 2007-02-15.
- [3] Masamitsu, Emily (May 2007). "The Best Compact Fluorescent Light Bulbs: PM Lab Test". *Popular Mechanics*. Retrieved 2007-05-15.
- [4] Amber Angelle, "Will LED Light Bulbs Best Your CFLs and Incandescents?" *Popular Mechanics* August 4, 2010 accessed May 30, 2011
- [5] Mary Bellis (2007). "The History of Fluorescent Lights". *About.com*. Retrieved 2008-02-13.
- [6] "Inventing Six Modern Electric Lamps: Compact Fluorescent – The Challenge of Manufacturing". National Museum of American History. Retrieved 18 June 2013.
- [7] Segall, Grant (20 July 2012). "Edward E. Hammer of Nela Park invented compact fluorescent light bulbs: news obituary". *Cleveland.com*. Sun Newspapers. Retrieved 18 June 2013.
- [8] Michael Kanellos (August 2007). "Father of the compact fluorescent bulb looks back". *CNet News*. Retrieved 2007-07-17.
- [9] "Philips Tornado Asian Compact Fluorescent". *Lamptech.co.uk*. Retrieved 18 June 2013.
- [10] Raymond Kane, Heinz Sell *Revolution in lamps: a chronicle of 50 years of progress (2nd ed.)*, The Fairmont Press, Inc. 2001 ISBN 0-88173-378-4 pp. 189–190.
- [11] What Compact Fluorescents to Use Where. Accessed 1 January 2008.
- [12] "A Dealer Guide to Energy Star: Putting Energy into Profits" (PDF).
- [13] "CFL Reflector Products". Pacific Northwest National Laboratory. 2007-10-02. Retrieved 2007-12-24.

- [14] “Press Releases | LRC Newsroom”. Lrc.rpi.edu. 2009-03-16. Retrieved 2012-07-15.
- [15] Buying and Selling Gems: What Light is Best? Part II: Artificial Light – The Options Available See figures 6 and 7
- [16] General Electric *Incandescent lamps TP110*, technical pamphlet published in 1976, no ISBN or Library of Congress number, page 8
- [17] “Osram Dulux EL Energy-Saving Lamps” (PDF). Osram. Archived from the original (PDF) on 2006-07-22. Retrieved 2007-12-24.
- [18] “IEC 60969 - Self-ballasted lamps for general lighting services — Performance requirements”. Collaborative Labelling and Appliance Standards Program. Archived from the original on Feb 26, 2008. Retrieved 2007-12-24.
- [19] Damir, B (2012). “Longevity of light bulbs and how to make them last longer”. RobAid. Retrieved 4 January 2013.
- [20] “When to turn off your lights”. *Energy Savers*. United States Department of Energy. 2009-02-24. Retrieved 2009-07-03.
- [21] Guan, Fumin; Reynolds, Dale (May 2005). *Topic and Discussions on the Performance Standard and Inspection Methods of CFL*. Right Light 6: 6th International Conference on Energy-Efficient Lighting. Archived from the original on 2007-08-07.
- [22] Charles P. Halsted (March 1993). “Brightness, Luminance, and Confusion”. *Information Display*. Naval Air Warfare Center Warminster, PA. Retrieved 2007-10-07. If the luminance of a viewed light source is increased 10 times, viewers do not judge that the brightness has increased 10 times. The relationship is, in fact, logarithmic: the sensitivity of the eye decreases rapidly as the luminance of the source increases. It is this characteristic that allows the human eye to operate over such an extremely wide range of light levels.
- [23] Krešimir Matković (December 1997). “Colour Science Basics: Human Vision”. *Tone Mapping Techniques and Color Image Difference in Global Illumination*. Institut für Computergraphik eingereicht an der Technischen Universität Wien. Retrieved 2007-10-07. It is interesting, that despite that incoming light can have a dynamic range of nearly 14 log units, the neural units can transfer the signal having the dynamic range of only about 1.5 log units. It is obvious that there is some adaptation mechanism involved in our vision. It means that we adapt to some luminance value, and then we can perceive data in a certain dynamic range near the adaptation level. One of the most important characteristics that changes with different adaptation levels is the just noticeable difference.
- [24] “Topic and Discussions on the Performance Standard and Inspection Methods of CFL” (PDF). Retrieved 2007-04-13.
- [25] “Energy Star Lighting Verification Program (Program for the Evaluation and Analysis of Residential Lighting) Semi-annual report for the period of October 2003 to April 2004” (PDF). Retrieved 2007-04-13.
- [26] “Quality Assurance in Energy Star Residential Lighting Programmes” (PDF). Retrieved 2007-04-13.
- [27] US Department of Energy. “Lighting”. *Energy Efficiency & Renewable Energy*. US Department of Energy. Archived from the original on October 15, 2011. Retrieved 2 October 2011.
- [28] 50/680 = 7%; 70/680 = 10%
- [29] 10/680 = 1.5%; 17/680 = 2.5%
- [30] Keefe, T. J. (2007). “The Nature of Light”. Community College of Rhode Island. Retrieved 18 September 2010.
- [31] United Nations Environment Programme (1 Dec 2010). “Multibillion dollar benefits of global switch to energy-efficient lighting” (Press release). United Nations Environment Programme. Retrieved 2 October 2011.
- [32] en.lighten (2010). “UNITED STATES OF AMERICA”. *en.lighten*. United Nations Environment Programme. Retrieved 2 October 2011.
- [33] <http://www.enlighten-initiative.org/portal/CountrySupport/CLAs/ClimateChangeMitigationBenefits/tabid/79155/Default.aspx>
- [34] “Learn About Light Output : ENERGY STAR”. Energystar.gov. Retrieved 2012-07-15.
- [35] one example has been found, at URL: <http://www.amazon.com/PacLights-Ultra150-Performance-Equivalent-Replacement/dp/B00F9CM49Y>
- [36] “Efficient lighting equals higher heat bills: study”. CBC News. 2009-03-04.
- [37] FAQ: The End of the Light Bulb as We Know It. *U.S. News & World Report*, 19 December 2007.
- [38] Chernoff, Harry (2008-01-23). “The Cost-Effectiveness of Compact Fluorescents in Commercial Buildings”. *EnergyPulse*. Retrieved 2008-03-21.
- [39] Whoriskey, Peter (2010-09-08). “Light bulb factory closes; End of era for U.S. means more jobs overseas”. *The Washington Post*. Retrieved 2011-06-02.
- [40] Jim Davenport (28 March 2011). “SC lawmakers take dim view of new light bulbs”. *MSNBC*.
- [41] Energy saving light bulbs offer dim future, *The Telegraph*, August 29, 2009
- [42] “Section III.3”. Europa.eu. Retrieved 2012-07-15.
- [43] Compact Fluorescent Lights, Halifax Regional Fire & Emergency
- [44] National Electrical Manufacturer’s Association NEMA, *Failure Modes for Self-Ballasted Compact Fluorescent Lamps*, white paper no. LSD 40, retrieved 2008-06-26.
- [45] “New household lamp standards, discusses co-ordinated U.S., Mexico and Canada standard UL 1993, retrieved 2009 Dec 3”. Csa.ca. Retrieved 2012-07-15.

- [46] GE Lighting FAQ for CFL retrieved 12 March 2007
- [47] http://www.energystar.gov/index.cfm?c=cfls.pr_cfls_warranty
- [48] <http://www.lutron.com/en-US/Education-Training/Pages/LCE/DimmingCFLsandLEDs.aspx>
- [49] “Dimmable CFLs”. Dimmable CFLs. Retrieved 2012-07-15.
- [50] Yau, E. K. F.; Wing-Hung Ki; Mok, P. K. T.; Sin, J. K. O. (2001). “Phase-controlled dimmable CFL with PFC and switching frequency modulation”. *2001 IEEE 32nd Annual Power Electronics Specialists Conference (IEEE Cat. No.01CH37230)* **2**. p. 951. doi:10.1109/PESC.2001.954241. ISBN 0-7803-7067-8.
- [51] Korovesis, Ph. N. et al. (2004). “Influence of Large-Scale Installation of Energy Saving Lamps on the Line Voltage Distortion of a Weak Network Supplied by Photovoltaic Station”. *IEEE Transactions on Power Delivery* **19** (4): 1787–1793. doi:10.1109/TPWRD.2004.835432.
- [52] Cunill-Solà, J.; Salichs, M. (2007). “Study and Characterization of Waveforms from Low-Watt (<25 W) Compact Fluorescent Lamps with Electronic Ballasts”. *IEEE Transactions on Power Delivery* **22** (4): 2305–2311. doi:10.1109/TPWRD.2007.899551.
- [53] “Compact Fluorescent Lamps”. Mge.com. Retrieved 2012-07-15.
- [54] Anibal T. De Almeida: *Understanding Power Quality, Home Energy Magazine*
- [55] http://www.energy.ca.gov/2007_energypolicy/documents/2007-06-19_workshop/comments/1-Fernstrom_PGE_Residential-Lighting-Improvement-Opportunities.pdf
- [56] Can CFLs interfere with electronic equipment? at ConsumerReports.org. Accessed 1 January 2008.
- [57] “Compact Fluorescent Light Bulbs Key Product Criteria : ENERGY STAR”. Energystar.gov. 2008-12-02. Retrieved 2012-07-15.
- [58] “Coming to Terms with Energy Efficiency and the Environment”. The Clean Air Partnership. Archived from the original on Oct 11, 2007.
- [59] U.S. Dept. of Energy, Greening Federal Facilities, 2nd Edition, 'Compact Fluorescent Lighting'. DOE/GO=102001-1165 page 87. Retrieved 22 February 2007. “Even when low-temperature ballasts are used, lamps will not reach full brightness for several minutes in cold weather.”
- [60] “Why does my compact fluorescent light bulb flicker or appear dim when I first turn it on?”. *Compact Fluorescent Light Bulb (CFL) FAQs*. GE Lighting. Retrieved 2009-06-15.
- [61] “GE Lighting Frequently Asked Questions — Compact Fluorescent (CFL): 4. Can I use a CFL in applications where I will be turning the lights on/off frequently?”. Retrieved 2007-04-13.
- [62] “I’ve noticed some CFLs need a few minutes to warm up, or reach full brightness ...”. *Customer Help FAQ*. Energy Star. Retrieved 2009-06-15.
- [63] “Why does it take time for CFL bulbs to come up to full brightness?”. *Efficient Lighting FAQs*. City of Fort Collins. Retrieved 2009-06-15.
- [64] “Karheim Hybrid CFL”.
- [65] “GE Hybrid CFL”.
- [66] “Energy-Saving Lamps & Health”. GreenFacts site. Retrieved 2009-06-10.
- [67] “Ultraviolet light output of compact fluorescent lamps: comparison to conventional incandescent and halogen residential lighting sources”. PubMed. Retrieved 2014-04-12.
- [68] Mironava, T.; Hadjiargyrou, M.; Simon, M.; Rafailovich, M. H. (20 Jul 2012). “The Effects of UV Emission from Compact Fluorescent Light Exposure on Human Dermal Fibroblasts and Keratinocytes In Vitro”. *Photochemistry and Photobiology*. doi:10.1111/j.1751-1097.2012.01192.x.
- [69] CPSC, Teng Fei Trading Inc. Announce Recall of Energy Saving Light Bulbs. U.S. Consumer Product Safety Commission press release. Accessed 1 January 2008.
- [70] “Mercury Content Information Available for Lamps on the 2003 New Jersey Contract T-0192”. Archived from the original on 2005-12-30. Retrieved 2007-05-15.
- [71] “Canada-Wide Standard for Mercury-Containing Lamps” (PDF). 2001. Retrieved 2007-03-23.
- [72] “Frequently Asked Questions Information on Compact Fluorescent Light Bulbs (CFLs) and Mercury June 2008” (PDF). 2008. Retrieved 2008-08-31.
- [73] “Mercury in Fluorescent Lamps”. *FAQ*. Energy Federation Incorporated. Retrieved 2009-07-02.
- [74] “NEMA Lamp Companies Announce Commitment to Cap CFL Mercury Content”. Retrieved 2007-03-23.
- [75] “Frequently Asked Questions, Information on Proper Disposal of Compact Fluorescent Light Bulbs (CFLs)” (PDF). Retrieved 2007-03-19.
- [76] “Frequently Asked Questions Information on Compact Fluorescent Light Bulbs (CFLs) and Mercury July 2008”, accessed 2009 Dec 22” (PDF). Retrieved 2012-07-15.
- [77] *What are the mercury emissions caused by humans? Do CFLs that wind up in a landfill contribute to these emissions?* retrieved January 5, 2009
- [78] http://www.energystar.gov/ia/partners/promotions/change_light/downloads/Fact_Sheet_Mercury.pdf
- [79] Daley, Beth (February 26, 2008). “Mercury leaks found as new bulbs break”. *The Boston Globe* (NY Times Co). Retrieved 2009-03-07.
- [80] “Maine Compact Fluorescent Lamp Breakage Study Report”. State of Maine, Dept of Environmental Protection. February 2008. Retrieved 2009-03-07.

- [81] “Cleaning Up a Broken CFL”. United States Environmental Protection Agency. 6 June 2013. Retrieved 18 June 2013.
- [82] “Maine Compact Fluorescent Light Breakage Study Report”. Maine Department of Environmental Protection. February 2008. Retrieved 2011-07-18.
- [83] “How are mercury-containing bulbs (called “lamps” in the regulations) regulated?”. United States Environmental Protection Agency. 10 May 2013. Retrieved 18 June 2013.
- [84] Rosenbloom, Stephanie (24 June 2008). “Home Depot Offers Recycling for Compact Fluorescent Bulbs”. *The New York Times*. Retrieved 18 June 2013.
- [85] “Compact Fluorescent Lamp Recycling Project Phase I Draft Report Background Research and Program Options” (PDF).
- [86] Ivanco, M., Karney, B.W., Waher, K.J. “To Switch, or Not to Switch: A Critical Analysis of Canada’s Ban on Incandescent Light Bulbs,” IEEE Electrical Power Conference, 25-26 Oct. 2007. pages 550–555 doi:10.1109/EPC.2007.4520391
- [87] 200 0000+ solar powered kerosene-lamp replacements assisted by aid agencies: <http://www.ashdenawards.org/winners/mpgvm>, <http://www.ashdenawards.org/winners/Dlight10>, <http://www.unescap.org/esd/bazaar/documents/PPT-Sunlabob-LaoPDR.pdf>
- [88] “Program for Evaluation and Analysis of Residential Lighting (PEARL) | Programs | LRC”. Lrc.rpi.edu. Retrieved 2012-07-15.
- [89] <http://www.lrc.rpi.edu/resources/newsroom/pdf/2007/PEARL8511.pdf>
- [90] *Energy Star Program Requirements for CFLS Partner Commitments*, 4th edition, dated 3 July 2008, retrieved 2008-06-25.
- [91] “Energy saving lightbulbs”. Energysavingtrust.org.uk. Retrieved 2012-07-15.
- [92] *DOE Solid-State Lighting CALiPER Program Summary of Results: Round 6 of Product Testing*. (PDF). U.S. Department of Energy. September 2008.
- [93] *DOE Solid-State Lighting CALiPER Program Summary of Results: Round 12 of Product Testing*. (PDF). U.S. Department of Energy. June 2011.
- [94] <http://www.mnn.com/earth-matters/energy/stories/should-i-buy-led-or-cfl-light-bulbs>
- [95] “LPrize-winner_media-kit.pdf”. U.S. Department of Energy. Archived from the original (PDF) on 6 August 2011. Retrieved 11 March 2013.
- [96] 3100°K is typical; individual bulbs vary. See Temperature of a Halogen Light Bulb, The Physics Factbook, Glenn Elert, ed., (Retrieved 2012-05-12)

15.10 External links

- The European lamp industry’s strategy for domestic lighting: Frequently Asked Questions & Answers on energy efficient lamps
- A technical description of a typical CFL circuit
- CFL Intelligence
- Energy Savings Calculator Compare the costs for each light bulb tight and learn how you can save money by switching to more energy efficient bulbs
- CFL Bulb Reference Guide CFL Bulb Reference Guide

Chapter 16

Neon lamp

See also: Neon lighting

A **neon lamp** (also **neon glow lamp**) is a miniature gas



A General Electric NE-34 glow lamp, manufactured circa 1930.

discharge lamp. The lamp typically consists of a small glass capsule that contains a mixture of neon and other gases at a low pressure and two electrodes (an anode and a cathode). When sufficient voltage is applied and sufficient current is supplied between the electrodes, the lamp produces an orange glow discharge. The glowing portion in the lamp is a thin region near the cathode; the larger and much longer neon signs are also glow discharges, but they use the positive column which is not present in the ordinary neon lamp. Neon glow lamps are widely used as indicator lamps in the displays of electronic instruments and appliances.

16.1 History

Neon was discovered in 1898 by William Ramsay and Morris W. Travers. The characteristic, brilliant red color that is emitted by gaseous neon when excited electrically was noted immediately; Travers later wrote, “the blaze of crimson light from the tube told its own story and was a sight to dwell upon and never forget.”^[1]

Neon’s scarcity precluded its prompt application for electrical lighting along the lines of Moore tubes, which used electric discharges in nitrogen. Moore tubes were commercialized by their inventor, Daniel McFarlan Moore, in the early 1900s. After 1902, Georges Claude’s company,

Air Liquide, was producing industrial quantities of neon as a byproduct of his air liquefaction business, and in December 1910 Claude demonstrated modern neon lighting based on a sealed tube of neon. In 1915 a U.S. patent was issued to Claude covering the design of the electrodes for neon tube lights;^[2] this patent became the basis for the monopoly held in the U.S. by his company, Claude Neon Lights, through the early 1930s.^[3]

Around 1917, Daniel Moore developed the neon lamp while working at the General Electric Company. The lamp has a very different design from the much larger neon tubes used for neon lighting. The difference in design was sufficient that a U.S. patent was issued for the lamp in 1919.^[4] A Smithsonian Institution website notes, “These small, low power devices use a physical principle called coronal discharge. Moore mounted two electrodes close together in a bulb and added neon or argon gas. The electrodes would glow brightly in red or blue, depending on the gas, and the lamps lasted for years. Since the electrodes could take almost any shape imaginable, a popular application has been fanciful decorative lamps. Glow lamps found practical use as indicators in instrument panels and in many home appliances until the widespread commercialisation of Light-Emitting Diodes (LEDs) in the 1970s.”^[5]

16.2 Description

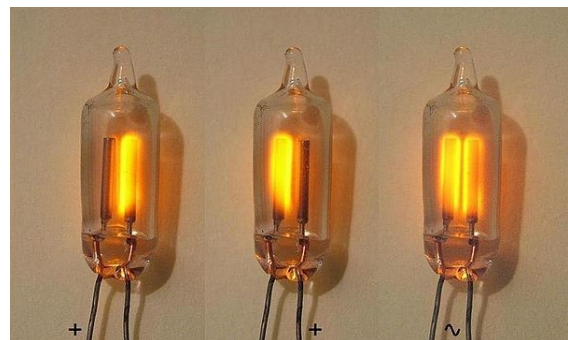

DC and AC supplied NE-2 type neon lamps

A small electric current, (For a 5 mm bulb diameter NE-2

lamp, the quiescent current is about 400 μA) which may be AC or DC, is allowed through the tube, causing it to glow orange-red. The gas is typically a Penning mixture, 99.5% neon and 0.5% argon, which has lower striking voltage than pure neon, at a pressure of 1-20 torr. The lamp glow discharge lights at its striking voltage. The voltage required to sustain the discharge is significantly (~30%) lower than the striking voltage. This is due to the organization of positive ions near the cathode. When driven from a DC source, only the negatively charged electrode (cathode) will glow. When driven from an AC source, both electrodes will glow (each during alternate half cycles). These attributes make neon bulbs (with series resistors) a convenient low-cost voltage testers; they determine whether a given voltage source is AC or DC, and if DC, the polarity of the points being tested. Neon lamps operate using a low current glow discharge. Higher power devices, such as mercury-vapor lamps or metal halide lamps use a higher current arc discharge. Low pressure sodium-vapor lamps use a neon Penning mixture for warm up and can be operated as giant neon lamps if operated in a low power mode.

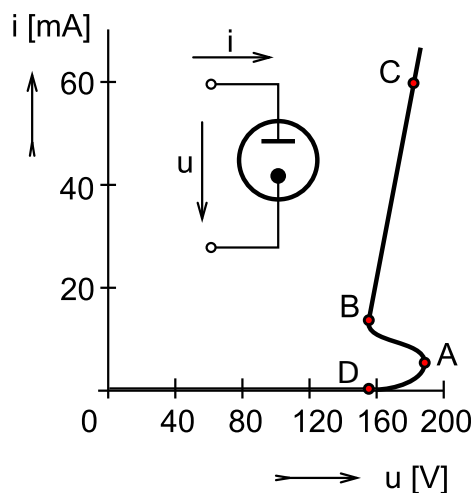

Graph showing the relationship between current and voltage across a neon lamp.^[6]

Once the neon lamp has reached breakdown, it can support a large current flow. Because of this characteristic, electrical circuitry external to the neon lamp must limit the current through the circuit or else the current will rapidly increase until the lamp is destroyed. For indicator-sized lamps, a resistor typically limits the current. Larger neon sign sized lamps often use a specially constructed high voltage transformer with high leakage inductance or other electrical ballast to limit the available current.

When the current through the lamp is lower than the current for the highest-current discharge path, the glow discharge may become unstable and not cover the entire surface of the electrodes.^[6] This may be a sign of aging of the indicator bulb, and is exploited in the decorative “flicker

flame” neon lamps. However, while too low a current causes flickering, too high a current increases the wear of the electrodes by stimulating sputtering, which coats the internal surface of the lamp with metal and causes it to darken.

The potential needed to strike the discharge is higher than what is needed to sustain the discharge. When there is not enough current, the glow forms around only part of the electrode surface. Convective currents make the glowing areas flow upwards, not unlike the discharge in a Jacob’s ladder. A photoionization effect can also be observed here, as the electrode area covered by the glow discharge can be increased by shining light at the lamp.

In comparison with incandescent light bulbs, neon lamps have much higher luminous efficacy. Incandescence is heat-driven light emission, so a large portion of the electric energy put into an incandescent bulb is converted into heat. Non-incandescent light sources such as neon light bulbs, fluorescent light bulbs, and light emitting diodes are therefore much more energy efficient than normal incandescent light bulbs. Green neon bulbs^[7] can produce up to 65 lumens per watt of power input, while white neon bulbs have an efficacy of around 50 lumens per watt. In contrast, a standard incandescent light bulb only produces around 13.5 lumens per watt.^[8]

16.3 Applications

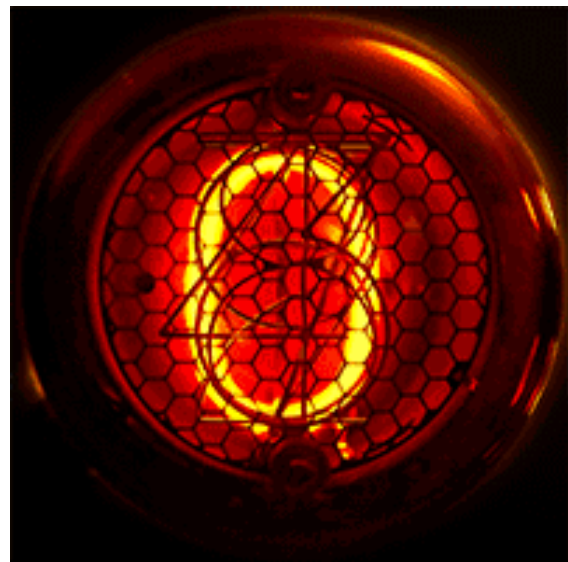

The digits of a Nixie tube.

Small neon lamps are most widely used as indicators in electronic equipment and appliances, due to their low power consumption, long life, and ability to operate off mains power. Larger lamps are used in neon signage. Most small neon (indicator-sized) lamps, such as the common NE-2, break down at between 90 and 110 volts.

The breakdown feature of neon lamps allows them to

be used as very simple voltage regulators or overvoltage protection devices. In the 1960s General Electric (GE), Signalite, and other firms made special extra-stable neon lamps for electronic uses.

Like other gas discharge lamps,^[9] the neon bulb has negative resistance; its voltage falls with increasing current after the bulb reaches its breakdown voltage.^{[10][11][12]} Therefore the bulb has hysteresis; its turn-off (extinction) voltage is lower than its turn-on (breakdown) voltage.^[13] This allows it to be used as an active switching element. Neon bulbs were used to make relaxation oscillator circuits,^{[13][14][11]} for low frequency applications such as flashing warning lights, stroboscopes^[15] tone generators in electronic organs,^[11] and as time bases and deflection oscillators in early cathode ray oscilloscopes.^[16] Neon bulbs can also be bistable, and were even used to build digital logic circuits such as logic gates, flip-flop, binary memories, and digital counters.^{[17] [18]} At least some of these lamps had a glow concentrated into a small spot on the cathode, which made them unsuited to use as indicators. These were sometimes called “circuit-component” lamps, the other variety being indicators. A variant of the NE-2 type lamp, the NE-77, had three parallel wires (in a plane) instead of the usual two. It was also intended primarily to be a circuit component.

Neon lamps have been historically used as microwave and millimeter-wave detectors ('plasma diodes' or GDDs-Glow Discharge Detectors) up to about 100 GHz or so and in such service were said to exhibit comparable sensitivity (of the order of a few 10s to perhaps 100 microvolts) to the familiar 1N23-type catwhisker-contacted silicon diodes once ubiquitous in microwave equipment. More recently it has been found that these lamps work well as detectors even at submillimeter ('terahertz') frequencies and they have been successfully used as pixels in several experimental imaging arrays at these wavelengths.

In these applications the lamps are operated either in 'starvation' mode (to reduce lamp-current noise) or in normal glow discharge mode; some literature references their use as detectors of radiation up into the optical regime when operated in abnormal glow mode. Coupling of microwaves into the plasma may be in free space, in waveguide, by means of a parabolic concentrator (e.g., Winston cone), or via capacitive means via a loop or dipole antenna mounted directly to the lamp.

In 1930s radio sets, neon lamps were used as tuning indicators, called “tuneons” and would give a brighter glow as the station was tuned in correctly. Because of their comparatively fast response time, in the early development of television neon lamps were used as the light source in many mechanical-scan TV displays.

Although most of these applications use ordinary off-the-shelf dual-electrode lamps, in one case it was found that special 3 (or more) electrode lamps, with the extra electrode acting as the coupling antenna, provided even better

results (lower noise and higher sensitivity). This discovery received an application patent (Kopeika et al.)

Neon lamps with several shaped electrodes were used as alphanumeric displays known as Nixie tubes. These have since been replaced by other display devices such as light emitting diodes, vacuum fluorescent displays, and liquid crystal displays. Novelty glow lamps with shaped electrodes (such as flowers and leaves), often coated with phosphors, have been made for artistic purposes. In some of these, the glow that surrounds an electrode is part of the design.

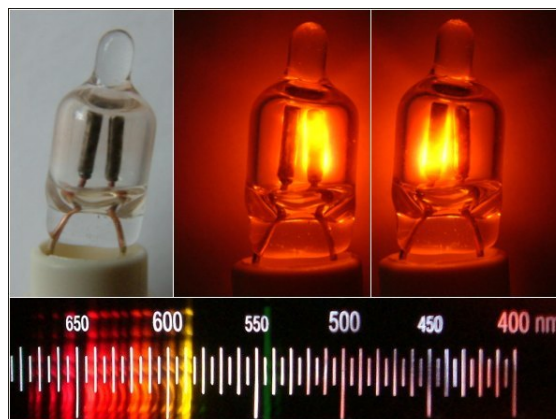

Unlit and lit neon lamps (NE-2 type) and their light spectrum.

16.3.1 Colour

Neon indicator lamps are normally orange, and are frequently used with a coloured filter over them to improve contrast and change their colour to red or a redder orange, or less often green.

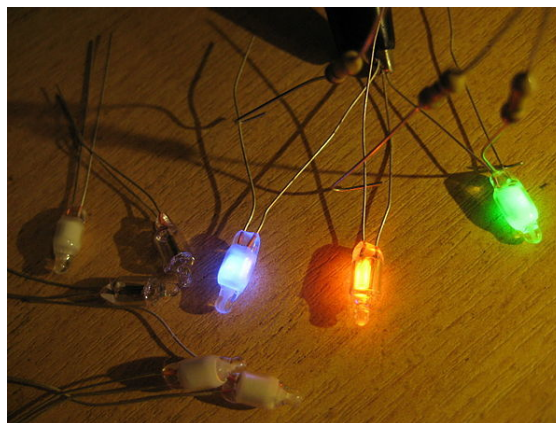

Phosphor-coloured neon lamps

They can also be filled with argon, krypton, or xenon rather than neon, or mixed with it. While the electrical operating characteristics remain similar, the lamps light with a bluish glow (including some ultraviolet) rather than neon's characteristic reddish-orange glow. Ultraviolet radiation then can be used to excite a phosphor coating in-

side of the bulb and provide a wide range of various colors, including white.^[19] A mixture of neon and krypton can be used for green glow, but nevertheless “green neon” lamps are more commonly phosphor-based.

16.3.2 Latching

Since at least the 1940s, argon, neon, and phosphored glow thyratron latching indicators (which would light up upon an impulse on their starter electrode and extinguish only after their anode voltage was cut) were available for example as self-displaying shift registers in large-format, crawling-text dot-matrix displays,^[20] or, combined in a 4x4, four-color phosphored-thyratron matrix, as a stackable 625-color RGBA pixel for large video graphics arrays.^[21] Multiple-cathode and/or anode glow thyratrons called Dekatrons could count forwards and backwards while their count state was visible as a glow on one of the numbered cathodes.^[22] These were used as self-displaying divide-by-n counter/timer/prescalers in counting instruments, or as adder/subtracters in calculators.

16.4 See also

- Timeline of lighting technology
- List of light sources
- Pearson-Anson effect
- Magic eye tube
- Neon sign
- Light art

16.5 References

- [1] Weeks, Mary Elvira (2003). *Discovery of the Elements: Third Edition (reprint)*. Kessinger Publishing. p. 287.
- [2] US 1125476, Georges Claude, “Systems of Illuminating by Luminescent Tubes”, issued 1915-01-19
- [3] “Claude Neon Lights Wins Injunction Suit: Also Gets Rights to Recover Profits and Damages Resulting From Patent Infringement”. *The New York Times*. November 28, 1928. Paid access.
- [4] US patent 1316967, Daniel McFarlan Moore, “Gaseous Conduction Lamp”, issued 1919-09-23, assigned to General Electric Company
- [5] “Lamp Inventors 1880-1940: Moore Lamp”. The Smithsonian Institution.
- [6] C.R. Dougherty, T.D. Foulke, J.D. Harden, T.L. Hewitt, F.N. Peters, R.D. Smith, and J.W. Tuttle, *General Electric Glow Lamp Manual*, 2nd ed. (General Electric Company, 1966), Chapter 1: Physics and characteristics of glow lamps: Theory of gaseous conduction in the glow lamp, pages 1-3; see Fig. 1.1, Characteristic curve of the neon lamp. In the current vs. voltage curve in this article, the portion of the curve between points A and B correspond to the points E and F in Fig. 1.1. From p. 2: “After breakdown occurs the lamp passes through a transition region EF which is an unstable region of operation. The shaded portion indicates the region in which oscillation can occur. This region is often referred to as the *negative resistance region*, since voltage decreases as current increase[s], contrary to normal behavior in a resistive element. ... As the current through the lamp is allowed to increase further, the lamp enters the *normal glow* discharge region represented by section FG [where the point G corresponds to the point C in the current vs. voltage graph of this article] in Fig. 1.1 where voltage changes a minimum amount with a change in current. ... In the normal glow region the glow is confined to a portion of the cathode surface and the amount of cathode surface covered by the glow is somewhat proportional to the tube current.”
- [7] “Other emitted colors such as green, yellow and blue are available through secondary emission by coating the inside surface of the envelope with phosphor.” — International Light Technology
- [8] Thielen, Marcus (2006-02-10). “LED or Neon”. Retrieved 2008-12-30.
- [9] Raju, Gorur Govinda (2006). *Gaseous Electronics: Theory and Practice*. Taylor and Francis. p. 453. ISBN 0849337631.
- [10] Daugherty, C. L.; Tuttle, J.W. et al. (1965). *G.E. Glow Lamp Manual, 2nd Ed.* Cleveland, Ohio: General Electric. p. 2.
- [11] Bauman, Edward (1966). *Applications of Neon Lamps and Discharge Tubes*. USA: Carleton Press. p. 18.
- [12] Dance, J. B. (1968). *Cold Cathode Tubes*. London: Iliffe. p. 7.
- [13] Gottlieb, Irving M. (1997). *Practical Oscillator Handbook*. Elsevier. pp. 69–70. ISBN 0080539386.
- [14] GE Glow Lamp Manual 1965, p.14-18
- [15] Burton, Walter E. (February 1948). “Magic with neon glow lamps”. *Popular Science* (New York: Popular Science Publishing Co.) **152** (2): 194–196. ISSN 0161-7370. Retrieved April 14, 2014.
- [16] Wahl, Horst D. (2005). “Tutorial Oscilloscope” (PDF). *Phys4822L Advanced Lab-Experiment 11: Studies of electrons with a CRT*. Prof. Horst D. Wahl, Physics Dept., Florida State Univ. Retrieved April 14, 2014.
- [17] GE Glow Lamp Manual 1965, p.35-36, 41-66
- [18] See:
 - William G. Miller, *Using and Understanding Miniature Neon Lamps* (Indianapolis, Indiana: Howard W. Sams, 1969).
 - A.A. Vuylsteke, “Neon lamp flip-flop and binary counter,” *Electronics*, vol. 26, page 248 (April 1953).

- M.S. Raphael and A.S. Robinson, “Digital storage using neon tubes,” *Electronics*, vol. 29, pages 162-165 (July 1956).
 - Charles E. Hendrix, “A study of the neon bulb as a nonlinear circuit element,” *Proceedings of the Institute of Radio Engineers: Transactions on component parts*, vol. 3, no. 2, pages 44-54 (September 1956). (Use of neon lamps in “and” and “or” gates.)
 - J.C. Manley and E.F. Buckley, “Neon diode ring counter,” *Electronics*, vol. 23, pages 84-87 (January 1950).
 - R.L. Ives, “Neon oscillator rings,” *Electronics*, vol. 31, pages 108-115 (10 October 1958).
 - C.E. Hendrix and R.B. Purcell, “Neon lamp logic gates play tic-tac-toe,” *Electronics*, vol. 31, pages 68-69 (20 June 1958).
- [19] Yen, William M.; Yamamoto, Hajime (2007). *Phosphor handbook*. CRC Press. p. 442. ISBN 978-0-8493-3564-8.
- [20] “Philips, 1968: *ZC1050* data sheet” (PDF). Retrieved 10 May 2013.
- [21] “Melz, 1944: *ИДИКАТОР ИТМ2-М* data sheet” (PDF). Retrieved 9 May 2013.
- [22] “ETL: *GCA10G/GSA10G* data sheet” (PDF). Retrieved 10 May 2013.

Chapter 17

Mercury-vapor lamp

“Mercury Lamp” redirects here. For the character in the Rozen Maiden anime and manga, see Characters of Rozen Maiden.

A **mercury-vapor lamp** is a gas discharge lamp that



A 175-watt mercury-vapor yard light approximately 15 seconds after starting

uses an electric arc through vaporized mercury to produce light. The arc discharge is generally confined to a small fused quartz arc tube mounted within a larger borosilicate glass bulb. The outer bulb may be clear or coated with a phosphor; in either case, the outer bulb provides thermal insulation, protection from the ultraviolet radiation the light produces, and a convenient mounting for the fused quartz arc tube.

Mercury vapor lamps are more energy efficient than incandescent and most fluorescent lights, with luminous efficacies of 35 to 65 lumens/watt.^[1] Their other advantages are a long bulb lifetime in the range of 24,000 hours and a high intensity, clear white light output.^[1] For these reasons, they are used for large area overhead lighting, such as in factories, warehouses, and sports arenas as well as for streetlights. Clear mercury lamps produce white light with a bluish-green tint due to mercury's combination of spectral lines.^[1] This is not flattering to human skin color, so such lamps are typically not used in retail stores.^[1] “Color corrected” mercury bulbs overcome this problem with a phosphor on the inside of the outer bulb

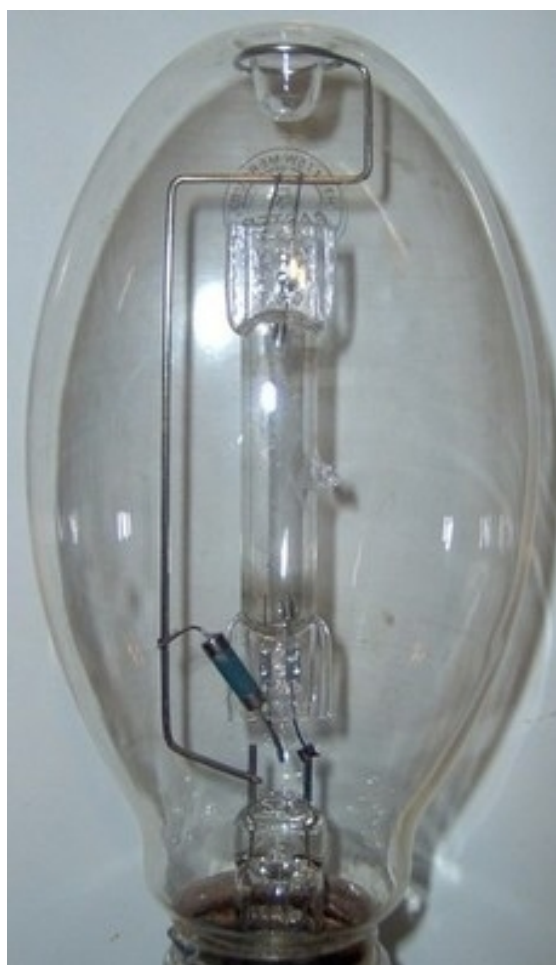

A closeup of a 175-W mercury vapor lamp. The small diagonal cylinder at the bottom of the arc tube is a resistor which supplies current to the starter electrode.

that emits white light. They offer better color rendition than the more efficient high or low-pressure sodium vapor lamps.

They operate at an internal pressure of around one atmosphere and require special fixtures, as well as an electrical ballast. They also require a warm-up period of 4–7 minutes to reach full light output. Mercury vapor lamps are becoming obsolete due to the higher efficiency and better color balance of metal halide lamps.^[2]

17.1 Origins

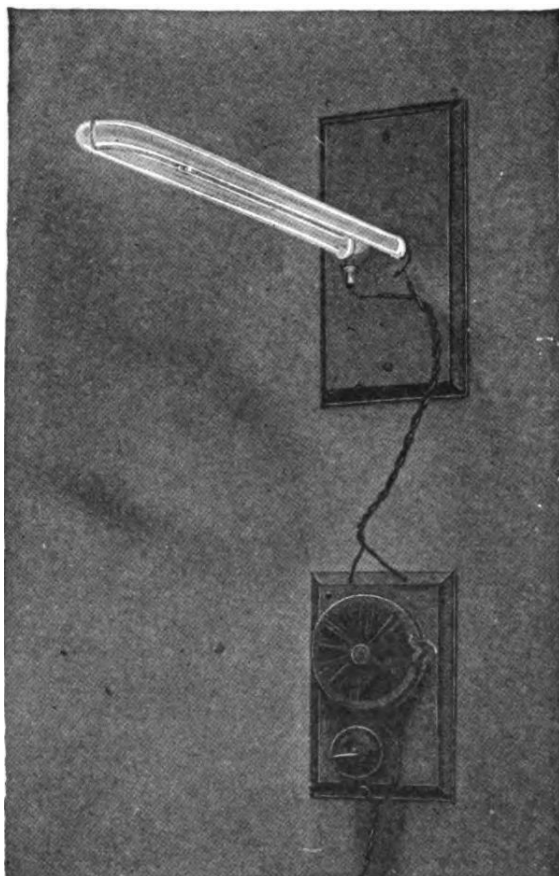

Cooper Hewitt lamp, 1903

Charles Wheatstone observed the spectrum of an electric discharge in mercury vapor in 1835, and noted the ultraviolet lines in that spectrum. In 1860, John Thomas Way used arc lamps operated in a mixture of air and mercury vapor at atmospheric pressure for lighting.^[3] The German physicist Leo Arons (1860–1919) studied mercury discharges in 1892 and developed a lamp based on a mercury arc.^[4]

The first mercury vapor lamp was invented in 1901 by American engineer Peter Cooper Hewitt.^[5] Hewitt was issued U.S. Patent 682,692 on September 17, 1901.^[6] In 1903, Hewitt created an improved version that possessed higher color qualities which eventually found widespread industrial use.^[5] The ultraviolet light from mercury vapor lamps was applied to water treatment by 1910. The Hewitt lamps used a large amount of mercury. In the 1930s, improved lamps of the modern form, developed by the Osram-GEC company, General Electric company and others led to widespread use of mercury vapor lamps for general lighting.

17.2 Principle of operation

The mercury in the tube is a liquid at normal temperatures. It needs to be vaporized and ionized before the tube will conduct electricity and the arc can start. So, like fluorescent tubes, mercury vapor lamps require a starter, which is usually contained within the mercury vapor lamp itself. A third electrode is mounted near one of the main electrodes and connected through a resistor to the other main electrode. In addition to the mercury, the tube is filled with argon gas at low pressure. When power is applied, there is sufficient voltage to ionize the argon and strike a small arc between the starting electrode and the adjacent main electrode. This starting arc discharge heats the mercury and eventually provides enough ionized mercury to strike an arc between the main electrodes. This process takes from 4 to 7 minutes, so mercury lamps are slow starting. Some bulbs include a thermal switch which shorts the starting electrode to the adjacent main electrode, extinguishing the starting arc once the main arc strikes.

The mercury vapor lamp is a negative resistance device. This means its resistance decreases as the current through the tube increases. So if the lamp is connected directly to a constant-voltage source like the power lines, the current through it will increase until it destroys itself. Therefore it requires a ballast to limit the current through it. Mercury vapor lamp ballasts are similar to the ballasts used with fluorescent lamps. In fact, the first British fluorescent lamps were designed to operate from 80-watt mercury vapor ballasts.

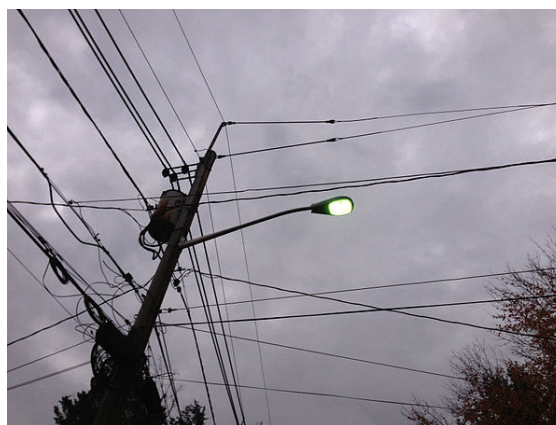

Mercury vapor street light

17.2.1 Metal halide

A very closely related lamp design called the metal halide lamp uses various compounds in an amalgam with the mercury. Sodium iodide and scandium iodide are commonly in use. These lamps can produce much better quality light without resorting to phosphors. If they use a starting electrode, there is always a thermal shorting



Closeup after dark



Warm-up of a color corrected 80 W high-pressure mercury vapor lamp to half brightness

switch to eliminate any electrical potential between the main electrode and the starting electrode once the lamp is lit. (This electrical potential in the presence of the halides can cause the failure of the glass/metal seal). More modern metal halide systems do not use a separate starting electrode; instead, the lamp is started using high voltage pulses as with high-pressure sodium vapor lamps.

17.2.2 Self-ballasted (SB) lamps

There are mercury vapor lamps with a filament inside connected in series with the arc tube that functions as an electrical ballast. This is the only kind of mercury vapor lamp that should be connected directly to the mains without an external ballast. These lamps have only the same or slightly higher efficiency than incandescent lamps of similar size, but have a longer life. They give light immediately on startup, but usually needs a few minutes to restrike if power has been interrupted. Because of the light emitted by the filament, they have slightly better color rendering properties than mercury vapor lamps. The color temperature is higher than incandescent lamps.

17.3 Operation

When a mercury vapor lamp is first turned on, it will produce a dark blue glow because only a small amount of the mercury is ionized and the gas pressure in the arc tube is very low, so much of the light is produced in the ultraviolet mercury bands. As the main arc strikes and the gas heats up and increases in pressure, the light shifts into the visible range and the high gas pressure causes the mercury emission bands to broaden somewhat, producing a light that appears more nearly white to the human eye, although it is still not a continuous spectrum. Even at full intensity, the light from a mercury vapor lamp with no phosphors is distinctly bluish in color. The pressure in the quartz arc-tube rises to approximately one atmosphere once the bulb has reached its working temperature. If the

discharge should be interrupted (e.g. by interruption of the electric supply), it is not possible for the lamp to restrike until the bulb cools enough for the pressure to fall considerably. The reason for a prolonged period of time before the lamp restrikes is because mercury vapor ballasts along with other HID lamp ballasts send relatively low voltage to the lamp upon start up, but as pressure increases inside the arc-tube, higher voltage is required to keep the lamp lit so the ballast sends higher voltage to the lamp. Once the ballast is shut off and turned on again, it starts over at a low voltage but if the lamp is still hot, then high pressure inside the arc-tube prevents the lamp from striking an arc and turning on.

17.3.1 Color considerations



Example of a phosphor-coated 125 W lamp

To correct the bluish tinge, many mercury vapor lamps are coated on the inside of the outer bulb with a phosphor that converts some portion of the ultraviolet emissions into red light. This helps to fill in the otherwise very-deficient red end of the electromagnetic spectrum. These lamps are generally called “color corrected” lamps. Most modern mercury vapor lamps have this coating. One of the original complaints against mercury lights was they tended to make people look like “bloodless corpses” because of the lack of light from the red end of the

spectrum.^[7] A common method of correcting this problem before phosphors were used was to operate the mercury lamp in conjunction with an incandescent lamp. There is also an increase in red color (e.g., due to the continuous radiation) in ultra-high-pressure mercury vapor lamps (usually greater than 200 atm.), which has found application in modern compact projection devices. When outside, coated or color corrected lamps can usually be identified by a blue “halo” around the light being given off.

17.3.2 Emission line spectrum

The strongest peaks of the emission line spectrum are^{[8][9]}



Line spectrum of mercury vapor. The blue-green tint of mercury vapor lamps is caused by the strong violet and green lines.

In low-pressure mercury-vapor lamps only the lines at 184 nm and 253 nm are present. Only the light at 253 nm is usable. Synthetic quartz can be used in the manufacturing to keep the 184 nm light from being absorbed. In medium-pressure mercury-vapor lamps, the lines from 200–600 nm are present. The lamps can be constructed to emit primarily in the UV-A (around 400 nm) or UV-C (around 250 nm). High-pressure mercury-vapor lamps are those lamp commonly used for general lighting purposes. They emit primarily in the blue and green.

17.4 Usage of low-pressure lamps for surface cleaning

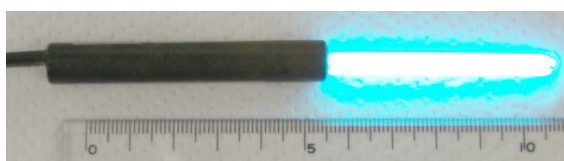

Low-pressure Hg lamps can be rather small, but efficient sources of deep UV light.

Low-pressure mercury-vapor lamps^[10] usually have a quartz bulb in order to allow the transmission of short wavelength light. If synthetic quartz is used, then the transparency of the quartz is increased further and an emission line at 185 nm is observed also. Such a lamp can then be used for the cleaning or modification of surfaces.^[11] The line 185 nm will create ozone in an oxygen containing atmosphere, which helps in the cleaning process, but is also a health hazard.

17.5 Light pollution considerations

For placements where light pollution is of prime importance (for example, an observatory parking lot), low-pressure sodium is preferred. As it emits narrow spectral lines at two very close wavelengths, it is the easiest to filter out. Mercury vapor lamps without any phosphor are second best; they produce only a few distinct mercury lines that need to be filtered out.

17.6 Bans

The use of mercury vapor lamps for lighting purposes will be banned in the EU in 2015. As this ban is designed to phase out less efficient lamps it does not affect the use of mercury in compact fluorescent lamp nor the use of mercury lamps for purposes other than lighting.^[12] In the US, ballasts and fixtures were banned in 2008.^[13] Because of this, several manufacturers have begun selling replacement compact fluorescent lamps for mercury vapor fixtures, which do not require modifications to the existing fixture.

17.7 Ultraviolet hazards

All mercury vapor lamps (including metal halide lamps) must contain a feature (or be installed in a fixture that contains a feature) that prevents ultraviolet radiation from escaping. Usually, the borosilicate glass outer bulb of the lamp performs this function but special care must be taken if the lamp is installed in a situation where this outer envelope can become damaged.^[14] There have been documented cases of lamps being damaged in gymnasiums by balls striking the lamps, resulting in sun burns and eye inflammation from shortwave ultraviolet radiation.^[15] When used in locations like gyms, the fixture should contain a strong outer guard or an outer lens to protect the lamp's outer bulb. Also, special “safety” lamps are made that will deliberately burn out if the outer glass is broken. This is usually achieved by using a thin carbon strip, which will burn up in the presence of air, to connect one of the electrodes.

Even with these methods, some UV radiation can still

pass through the outer bulb of the lamp. This causes the aging process of some plastics used in the construction of luminaires to be accelerated, leaving them significantly discolored after only a few years' service. Polycarbonate suffers particularly from this problem, and it is not uncommon to see fairly new polycarbonate surfaces positioned near the lamp to have turned a dull, 'ear-wax'-like color after only a short time. Certain polishes, such as Brasso, can be used to remove some of the yellowing, but usually only with limited success.

17.8 End of life

Mercury vapor lamps do burn out eventually as the burner electrodes wear, increasing the arc gap. As the lamp nears the end of life, lumen depreciation becomes noticeable and the light given off has a greenish tinge to it. This comes about because the emitter is deposited as a film darkening the arctube wall and reducing light output. The lamps also consume more than twice as much power.

17.9 Uses

17.9.1 Photoresist exposure

Ultra-high-pressure mercury vapor lamps are used in the area of photolithography to expose various photoresists. The unique spectral emission characteristics of mercury vapor lamps are ideal for photoresists, the most common of which are generally photosensitive between 350 and 500 nm wavelengths.

17.9.2 Area and street lighting

Although other types of HIDs are becoming more common, mercury vapor lamps are still commonly used for area lighting and street lighting in the United States.

17.9.3 Molecular spectroscopy

High-pressure mercury vapor (and some specially-designed metal-halide) lamps find application in molecular spectroscopy due to providing useful broadband continuum ('noise') energy at millimeter and terahertz wavelengths, owing to the high electron temperature of the arc plasma; the main UV emission line of ionized mercury (254 nm) correlates to a blackbody of $T=11,500$ K. This property makes them among the very few simple, inexpensive sources available for generating such frequencies. For example, a standard 250-watt general-lighting mercury lamp produces significant output from 120 GHz-6 THz. In addition, shorter wavelengths in the mid-infrared are emitted from the hot quartz arc-tube envelope. As

with the ultraviolet output, the glass outer bulb is largely opaque at these frequencies and thus for this purpose needs to be removed (or omitted in purpose-made lamps).

17.10 See also

- Ultra High Performance lamp
- History of street lighting in the United States
- List of light sources

17.11 References

- [1] Schiler, Marc (1997). *Simplified Design of Building Lighting, 4th Ed.* USA: John Wiley and Sons. p. 27. ISBN 0-471-19210-4.
- [2] Gendre, Maxime F. (2011). "Two Centuries of Electric Light Source Innovations" (PDF). Eindhoven Institute for Lighting Technology, Eindhoven Univ. of Technology, Eindhoven, Netherlands. Retrieved April 3, 2012.
- [3] Maxime F. Gendre Two Centuries of Electric Light Sources Innovations. p. 4. (PDF) . Retrieved on 2012-01-02.
- [4] Clement D. Child *Electric Arcs-Experiment Upon Arcs Between Different Electrodes in Various Environments*, reprint by Watchmaker Publishing, 2002 ISBN 0-9726596-1-7, p. 88
- [5] "Peter Cooper Hewitt". Encyclopædia Britannica.
- [6] "Method of Manufacturing Electric Lamps". United States Patent and Trademark Office.
- [7] "Mercury Vapor Lights". Retrieved 2014-11-25.
- [8] Persistent Lines of Neutral Mercury (Hg I). Physics.nist.gov. Retrieved on 2012-01-02.
- [9] Nave, Carl R. (2010). "Atomic Spectra". *HyperPhysics website*. Dept. of Physics and Astronomy, Georgia State Univ. USA. Retrieved 2011-11-15.
- [10] "Crystec Technology Trading GmbH, Low pressure mercury-vapor lamps".
- [11] "Crystec Technology Trading GmbH, Surface cleaning by UV-light".
- [12] Phasing out of mercury vapor lamps. www.osram.co.uk. Retrieved on 2015-03-18.
- [13] Mercury Vapor banned in 2008; S.10 Energy Policy Act of 2005. Mercuryvaporlight.com. Retrieved on 2012-01-02.
- [14] "Understanding high intensity discharge lighting". Osram Sylvania.
- [15] Thun, M. J.; Altman, R.; Ellingson, O.; Mills, L. F.; Talsansky, M. L. (1982). "Ocular complications of malfunctioning mercury vapor lamps". *Ann Ophthalmol.* **14** (11): 1017–20. PMID 7181332.

17.12 Further reading

- Waymouth, John (1971). *Electric Discharge Lamps*. Cambridge, MA: The M.I.T. Press. ISBN 0-262-23048-8.
- Museum of Electric Lamp Technology

Chapter 18

Sodium-vapor lamp



An unlit high pressure sodium lamp, Philips Master SDW-T 100W

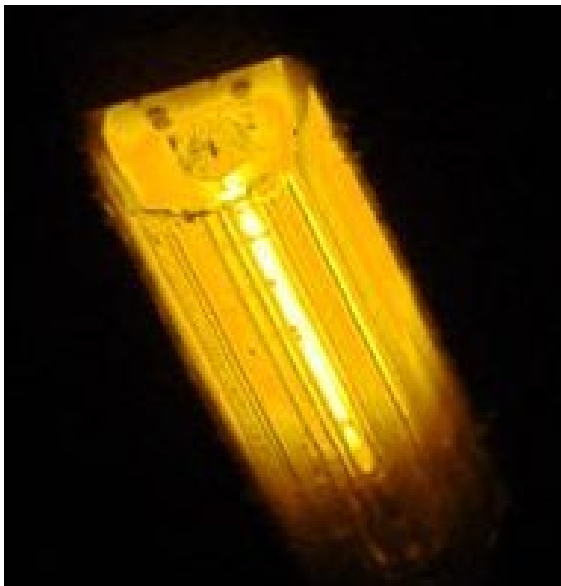

A low-pressure sodium streetlamp at full power

A **sodium-vapor lamp** is a gas-discharge lamp that uses sodium in an excited state to produce light. There are two varieties of such lamps: *low pressure* and *high pressure*. Low-pressure sodium lamps are highly efficient electrical light sources, but their yellow light restricts applications to outdoor lighting such as street lamps.^[1] High-pressure sodium lamps have a broader spectrum of light than the low-pressure lamps, but still poorer color rendering than other types of lamps.^[2] Low-pressure sodium lamps only give monochromatic yellow light and so inhibit color vision at night.

Because sodium-vapor lamps cause less light pollution than mercury-vapor lamps, many cities that have large astronomical observatories employ them.^[3]



A sodium vapor lamp

18.1 Low-pressure sodium



An unlit 35W LPS/SOX lamp

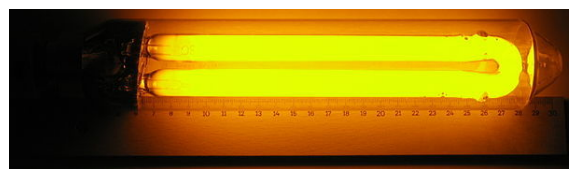

A running 35W LPS/SOX lamp

Low-pressure sodium (LPS) lamps have a borosilicate glass gas discharge tube (arc tube) containing solid sodium, a small amount of neon, and argon gas in a Penning mixture to start the gas discharge. The discharge tube may be linear (SLI lamp)^[4] or U-shaped. When the

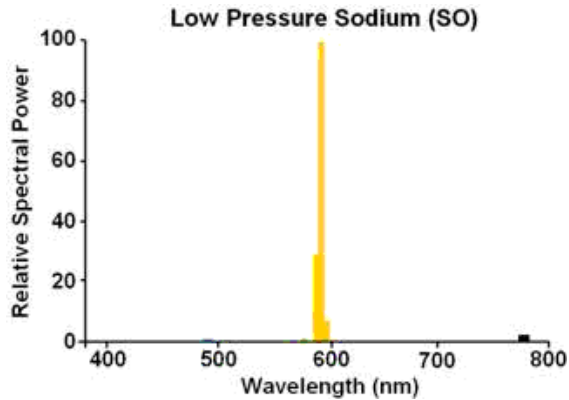

Spectrum of a low-pressure sodium lamp. The intense yellow band is the atomic sodium D-line emission, comprising about 90% of the visible light emission for this lamp type.

lamp is turned on it emits a dim red/pink light to warm the sodium metal and within a few minutes it turns into the common bright yellow as the sodium metal vaporizes. These lamps produce a virtually monochromatic light averaging a 589.3 nm wavelength (actually two dominant spectral lines very close together at 589.0 and 589.6 nm). As a result, the colors of illuminated objects are not easily distinguished because they are seen almost entirely by their reflection of this narrow bandwidth yellow light.

LPS lamps have an outer glass vacuum envelope around the inner discharge tube for thermal insulation, which improves their efficiency. Earlier types of LPS lamps had a detachable dewar jacket (SO lamps).^[5] Lamps with a permanent vacuum envelope (SOI lamps) were developed to improve thermal insulation.^[6] Further improvement was attained by coating the glass envelope with an infrared reflecting layer of indium tin oxide, resulting in SOX lamps.^[7]

LPS lamps are some of the most efficient electrically powered light sources when measured in photopic lighting conditions—producing up to 200 lm/W,^[8] partly because the light is at a wavelength near the peak sensitivity of the human eye. They are mainly used for outdoor lighting such as street lights and security lighting where faithful color rendition is considered unimportant. Recently it has been found that under typical nighttime mesopic driving conditions, whiter light can provide better results at a lower level.^[9]

LPS lamps are similar to fluorescent lamps because they are a low-intensity light source with a linear lamp shape. They do not exhibit a bright arc as do High-intensity discharge (HID) lamps; they emit a softer luminous glow, resulting in less glare. Unlike HID lamps, during a voltage dip low-pressure sodium lamps return to full brightness rapidly. LPS lamps are available with power ratings from 10 W up to 180 W; longer bulb lengths can however create design and engineering problems.

Another property of LPS lamps is they do not decline in lumen output with age. For example, mercury vapor HID

lamps become dimmer towards the end of their lives, to the point of being ineffective, while continuing to consume their rated electrical power. LPS lamps do increase their energy use slightly (by about 10%) towards the end of their life, which is generally about 18,000 hours for modern lamps.

18.1.1 Light pollution considerations

For placements where light pollution is of prime importance, such as near astronomical observatories or sea turtle nesting beaches, low-pressure sodium is preferred (such as in San Jose and Flagstaff, Arizona).^{[10][11]} Such lamps emit light on just two dominant spectral lines (with other far weaker lines), and therefore have the least spectral interference with astronomical observation.^[12] The yellow color of low-pressure sodium lamps also leads to the least visual sky glow, due primarily to the Purkinje shift of dark-adapted human vision, causing the eye to be relatively insensitive to the yellow light scattered at low luminance levels in the clear atmosphere.^{[13][14]} One consequence of widespread public lighting is that on cloudy nights, cities with enough lighting are illuminated by light reflected off the clouds. As sodium vapor lights are often the source of urban illumination, this turns the sky a tinge of orange.

18.1.2 Film special effects

Sodium vapor process (occasionally referred to as yellowscreen) is a film technique that relies on narrowband characteristics of LPS lamp. A yellow light of a LPS lamp falls into region that typical color negative is not sensitive to, but can be captured on special black-and-white film. A special camera can prepare two spools simultaneously: one with actors (or other foreground objects) and another which becomes a mask to combine them into different background. This technique originally yielded superior results compared to competing blue-screen, however advancements in blue- and green-screen techniques and computer imagery closed that gap, leaving SVP uncompetitive cost-wise. SVP was used in years 1956-1990, mostly by Disney. Notable example of films using this technique include Alfred Hitchcock's *The Birds*, *Mary Poppins*, and *Bedknobs and Broomsticks*.

18.2 High-pressure sodium

High-pressure sodium (HPS) lamps are smaller and contain elements such as mercury, produce a dark pink glow when first struck, and an intense pinkish orange light when warmed. Some bulbs also briefly produce a pure to bluish white light if the mercury achieves a high-pressure arc discharge before the sodium is completely warmed. The sodium D-line is the main source of light from the



High-pressure sodium lamp Philips SON-T Master 600 W

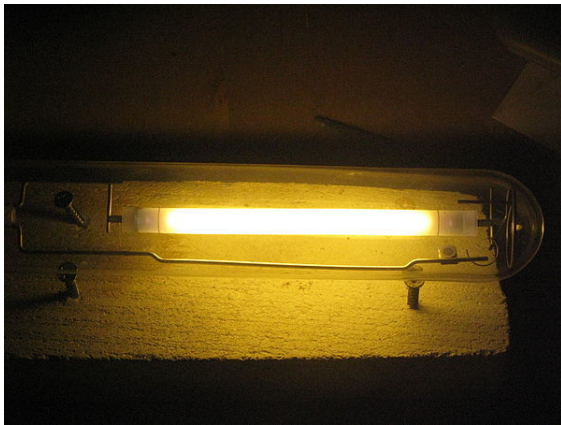

Same lamp in operation

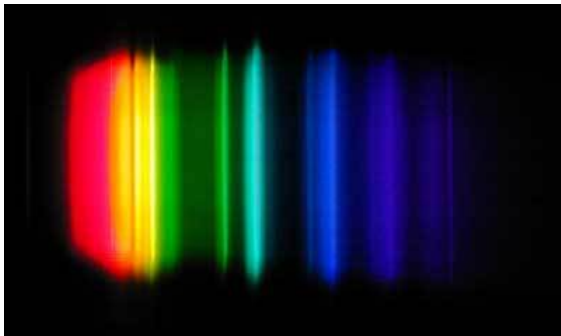

Spectrum of high-pressure sodium lamp. The yellow-red band on the left is the atomic sodium D-line emission; the turquoise line is a sodium line that is otherwise quite weak in a low pressure discharge, but becomes intense in a high-pressure discharge. Most of the other green, blue and violet lines arise from mercury.

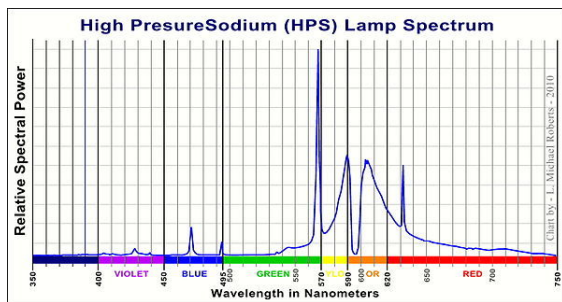

Diagram showing the spectral output of a typical high-pressure sodium (HPS) lamp.



Office building illuminated by high-pressure sodium lamps. Note the lamps shining upward, of which much light goes into the sky and neighboring apartment blocks, causing light pollution.

HPS lamp, and it is pressure broadened by the high pressure in the lamp. Because of this broadening plus the emissions from mercury, more colors can be distinguished compared to a low-pressure sodium lamp. This leads them to be used in areas where improved color rendering is important or desired. Thus, its new model name SON is the variant for “sun” (a name used primarily in Europe and the UK). HPS lamps are favored by indoor gardeners for general growing because of the wider color-temperature spectrum produced and the relatively low cost of operating them.

High-pressure sodium lamps are quite efficient—about 100 lm/W—when measured for photopic lighting conditions. The higher power versions of 600 W have an efficiency of 150 lm/W. They have been widely used for outdoor area lighting such as streetlights and security. Understanding the change in human color vision sensitivity from *photopic* to *mesopic* and *scotopic* is essential for proper planning when designing lighting for roads.^[9]

Because of the extremely high chemical activity of the high-pressure sodium arc, the arc tube is typically made of translucent aluminum oxide. This construction led General Electric to use the tradename “Lucalox” for their line of high-pressure sodium lamps.

Xenon at a low pressure is used as a “starter gas” in the HPS lamp. It has the lowest thermal conductivity and lowest ionization potential of all the non-radioactive noble gases. As a noble gas, it does not interfere with the chemical reactions occurring in the operating lamp. The low thermal conductivity minimizes thermal losses in the lamp while in the operating state, and the low ionization potential causes the breakdown voltage of the gas to be relatively low in the cold state, which allows the lamp to be easily started.

18.2.1 “White” SON

A variation of the high-pressure sodium, the White SON, introduced in 1986, has a higher pressure than the typical HPS/SON lamp, producing a color temperature of around 2700 K, with a CRI of 85, greatly resembling the color of an incandescent light.^[15] These are often used indoors in cafes and restaurants to create a particular atmosphere. However, these lamps suffer from higher purchase cost, shorter life, and lower light efficiency.

18.2.2 Theory of operation

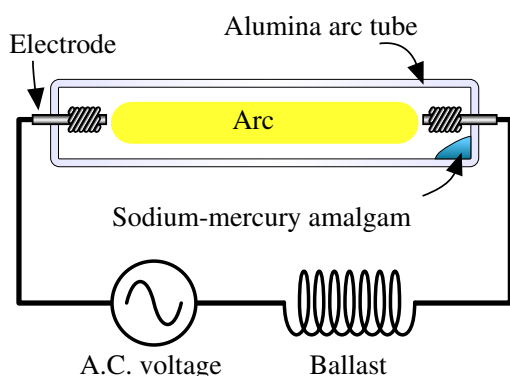

Diagram of a high-pressure sodium lamp.

An amalgam of metallic sodium and mercury lies at the coolest part of the lamp and provides the sodium and mercury vapor that is needed to draw an arc. The temperature of the amalgam is determined to a great extent by lamp power. The higher the lamp power, the higher will be the amalgam temperature. The higher the temperature of the amalgam, the higher will be the mercury and sodium vapor pressures in the lamp and the higher will be the terminal voltage. As the temperature rises, the constant current and increasing voltage result in increased power until the nominal power is reached. For a given voltage, there are generally three modes of operation:

1. The lamp is extinguished and no current flows.
2. The lamp is operating with liquid amalgam in the tube.
3. The lamp is operating with all amalgam evaporated.

The first and last states are stable, because the lamp resistance is weakly related to the voltage, but the second state is unstable. Any anomalous increase in current will cause an increase in power, causing an increase in amalgam temperature, which will cause a decrease in resistance, which will cause a further increase in current. This will create a runaway effect, and the lamp will jump to the high-current state (#3). Because actual lamps are not designed to handle this much power, this would result in

catastrophic failure. Similarly, an anomalous drop in current will drive the lamp to extinction. It is the second state that is the desired operating state of the lamp, because a slow loss of the amalgam over time from a reservoir will have less effect on the characteristics of the lamp than a fully evaporated amalgam. The result is an average lamp life in excess of 20,000 hours.

In practical use, the lamp is powered by an AC voltage source in series with an inductive "ballast" in order to supply a nearly constant current to the lamp, rather than a constant voltage, thus assuring stable operation. The ballast is usually inductive rather than simply being resistive to minimize resistive losses. Because the lamp effectively extinguishes at each zero-current point in the AC cycle, the inductive ballast assists in the reignition by providing a voltage spike at the zero-current point.

The light from the lamp consists of atomic emission lines of mercury and sodium, but is dominated by the sodium D-line emission. This line is extremely pressure (resonance) broadened and is also self-reversed because of absorption in the cooler outer layers of the arc, giving the lamp its improved color rendering characteristics. In addition, the red wing of the D-line emission is further pressure broadened by the Van der Waals forces from the mercury atoms in the arc.

18.3 End of life



Sodium vapor street light

At the end of life, high-pressure sodium lamps exhibit a phenomenon known as *cycling*, which is caused by a loss of sodium in the arc. Sodium is a highly reactive element and is easily lost by reacting with the arc tube, made of aluminum oxide. The products are sodium oxide and aluminum:

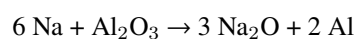

As a result, these lamps can be started at a relatively low voltage, but, as they heat up during operation, the internal



Closeup after dark

gas pressure within the arc tube rises, and more and more voltage is required to maintain the arc discharge. As a lamp gets older, the maintaining voltage for the arc eventually rises to exceed the maximum voltage output by the electrical ballast. As the lamp heats to this point, the arc fails, and the lamp goes out. Eventually, with the arc extinguished, the lamp cools down again, the gas pressure in the arc tube is reduced, and the ballast can once again cause the arc to strike. The effect of this is that the lamp glows for a while and then goes out, typically starting at a pure or bluish white then moving to a red-orange before going out.

More sophisticated ballast designs detect cycling and give up attempting to start the lamp after a few cycles, as the repeated high-voltage ignitions needed to restart the arc reduce the lifetime of the ballast. If power is removed and reapplied, the ballast will make a new series of startup attempts.

LPS lamp failure does not result in cycling; rather, the lamp will simply not strike or will maintain its dull red glow exhibited during the start-up phase. In another failure mode, a tiny puncture of the arc tube leaks some of the sodium vapor into the outer vacuum bulb. The sodium condenses and creates a mirror on the outer glass, partially obscuring the arc tube. The lamp often continues operating normally. Much of the light generated is obscured by the sodium coating and no longer leaves the lamp.

18.4 ANSI HPS ballast codes

18.5 See also

- Arc lamp
- High-intensity discharge lamp (HID)
- History of street lighting in the United States
- List of light sources

- Metal-halide lamp
- Mercury-vapor lamp
- Neon lamp
- Street light
- Sulfur lamp
- Light pollution

18.6 Notes

- [1] Public Works, Department of Public Works (1980). *San Jose: Study and report on low-pressure sodium lighting*. San Jose: City of San Jose. p. 8.
- [2] Luginbuhl, Christian B. “Low-Pressure Sodium Issues and FAQ”. *U.S. Naval Observatory Flagstaff Station*. US Navy. Retrieved December 5, 2013.
- [3] “Curious About Astronomy: How does light pollution affect astronomers?”. *Curious.astro.cornell.edu*. Retrieved 2012-03-03.
- [4] “SLI/H Sodium”. *Lamptech.co.uk*. Retrieved 2012-03-03.
- [5] “SO/H Sodium”. *Lamptech.co.uk*. Retrieved 2012-03-03.
- [6] “SOI/H Sodium”. *Lamptech.co.uk*. Retrieved 2012-03-03.
- [7] “SOX Sodium”. *Lamptech.co.uk*. Retrieved 2012-03-03.
- [8] “Why is lightning colored? (gas excitations)”. *WebExhibits*. Retrieved 2007-09-24.
- [9] “Mesoptic Street Lighting Demonstration and Evaluation Final Report” (PDF). Lighting research Center, Rensselaer Polytechnic Institute. January 31, 2008. Retrieved 2011-08-29. (Comparison is with HPS and MH lamps)
- [10]
- [11] “Flagstaff Lighting Code” (PDF). Retrieved 14 April 2014.
- [12] Luginbuhl, C. B. (12–16 July 1999), “Why Astronomy Needs Low-Pressure Sodium Lighting” (PDF), in R. J. Cohen; W. T. Sullivan, *Why Astronomy Needs Low-Pressure Sodium Lighting*, Preserving the Astronomical Sky, Proceedings of IAU Symposium 196, Vienna, Austria: International Astronomical Union (published 2001), p. 81
- [13] Luginbuhl, C. B.; Boley, P. A.; Daviws, D. R. (May 2014). “The impact of light source spectral power distribution on sky glow”. *Journal of Quantitative Spectroscopy and Radiative Transfer* (Elsevier) **139**: 21–26. doi:10.1016/j.jqsrt.2013.12.004.

- [14] Aubé, M.; Roby, J.; Kocifaj, M. (5 July 2013). "Evaluating Potential Spectral Impacts of Various Artificial Lights on Melatonin Suppression, Photosynthesis, and Star Visibility". *PLoS ONE* **8** (7): e67798. doi:10.1371/journal.pone.0067798.
- [15] "Philips SDW-T High Pressure Sodium White SON". *WebExhibits*. Retrieved 2007-09-24.

18.7 References

- de Groot, J J; van Vliet; J A J M (1986). *The High-Pressure Sodium Lamp*. Deventer: Kluwer Technische Boeken BV. ISBN 978-90-201-1902-2. OCLC 16637733.
- Waymouth, John F (1971). *Electric Discharge Lamps*. Cambridge, MA: MIT Press. ISBN 978-0-262-23048-3. OCLC 214331.
- Museum of Electric Discharge Lamps

Chapter 19

Sulfur lamp

The **sulfur lamp** (also **sulphur lamp**) is a highly efficient full-spectrum electrodeless lighting system whose light is generated by sulfur plasma that has been excited by microwave radiation. They are a particular type of plasma lamp, one of the most modern. The technology was developed in the early 1990s, but, although it appeared initially to be very promising, sulfur lighting was a commercial failure by the late 1990s. Since 2005, lamps are again being manufactured for commercial use.

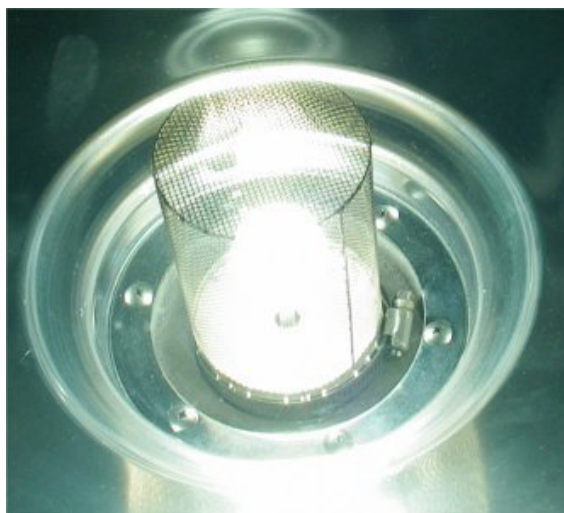

Sulfur lamp

19.1 Mechanism

The sulfur lamp consists of a golf ball-sized (30 mm) fused-quartz bulb containing several milligrams of sulfur powder and argon gas at the end of a thin glass spindle. The bulb is enclosed in a microwave-resonant wire-mesh cage. A magnetron, much like the ones in home microwave ovens, bombards the bulb, via a waveguide, with 2.45 GHz microwaves. The microwave energy excites the gas to five atmospheres pressure, which in turn heats the sulfur to an extreme degree forming a brightly glowing plasma capable of illuminating a large area. Because the bulb heats considerably, it is necessary to provide forced air cooling to prevent it from melting. The

bulb is usually placed at the focus of a parabolic reflector to direct all the light in one direction.

It would be impossible to excite the sulfur using traditional electrodes since the sulfur would quickly react with and destroy any metallic electrode. A patent pending to employ coated electrodes is discussed in *Future prospects* below. The absence of electrodes allows for a much greater variety of light-generating substances to be used than those used in traditional lamps.

The design life of the bulb is approximately 60,000 hours. The design life of the magnetron has been improved by the Germany/England based Plasma International so it can also last for that same period.

The warm-up time of the sulfur lamp is notably shorter than for other gas discharge lamps, with the exception of fluorescent lamps, even at low ambient temperatures. It reaches 80% of its final luminous flux within 20 seconds, and the lamp can be restarted approximately five minutes after a power cut.

The first prototype lamps were 5.9 kW units, with a system efficiency of 80 lumens per watt.^[1] The first production models were 96.4 lumens per watt. Later models were able to eliminate the cooling fan and improve luminous efficacy to 100 lumens per watt.^[2]

19.2 Quality of emitted light

The sulfur plasma consists mainly of dimer molecules (S_2), which generate the light through molecular emission. Unlike atomic emission, the emission spectrum is continuous throughout the visible spectrum. As much as 73% of the emitted radiation is in the visible spectrum, with a small amount in infrared energy and less than 1% in ultraviolet light.

The spectral output peaks at 510 nanometres, giving the light a greenish hue. The correlated color temperature is about 6,000 kelvins with a CRI of 79. The lamp can be dimmed to 15% without affecting the light quality.

A magenta filter can be used to give the light a warmer feel. Such a filter was used on the lamps at the National Air and Space Museum in Washington, D.C.^[3]

The addition of other chemicals in the bulb might improve color rendition. Sulfur lamp bulbs with calcium bromide (CaBr₂) added produce a similar spectrum plus a spike in red wavelengths at 625 nm.^[4] Other additives such as lithium iodide (LiI) and sodium iodide (NaI) can be used to modify the output spectra.^{[5][6][7]}

19.3 History

The technology was conceived by engineer Michael Ury, physicist Charles Wood and their colleagues in 1990. With support from the United States Department of Energy, it was further developed in 1994 by Fusion Lighting of Rockville, Maryland, a spinoff of the Fusion UV division of Fusion Systems Corporation. Its origins are in microwave discharge light sources used for ultraviolet curing in the semiconductor and printing industries. The Fusion UV division was later sold to Spectris plc, and the rest of Fusion Systems was later acquired by the Eaton Corporation.

Only two production models were developed, both with similar specifications: the Solar 1000 in 1994 and the Light Drive 1000 in 1997, which was a refinement of the previous model.

Production of these lamps ended in 1998.^[8] Fusion Lighting closed its Rockville, MD location in February 2003, after consuming approximately \$90 million in venture capital. Their patents were licensed to the LG Group. The Internet Archive has a copy of Fusion Lighting's defunct website. Their lamps were installed in more than one hundred facilities worldwide, but many of them have already been removed.

In 2001, Ningbo Youhe New Lighting Source Co., Ltd, in Ningbo, China, produced its own sulfur lamp version. The company's website is no longer online and may be out of business, but information on these lamps is available from its archived copy at the Internet Archive.

In 2006, LG Electronics began production of its sulfur lamps, called Plasma Lighting System (PLS).

19.4 Electromagnetic interference

The magnetrons in these lamps may cause electromagnetic interference in the 2.4 GHz wireless spectrum, which is used by Wi-Fi, cordless phones and satellite radio in North America. Fearing interference with their broadcasts, Sirius and XM satellite radio petitioned the United States Federal Communications Commission (FCC) to force Fusion Lighting to reduce the electromagnetic emissions of their lamps by 99.9%. In 2001, Fusion Lighting agreed to install metal shielding around their lamps to reduce electromagnetic emissions by 95%.

In May 2003, the FCC terminated the proceeding that would have defined out-of-band emission limits for radio-frequency lights operating at 2.45 GHz, saying the record of the proceeding had become outdated and Fusion Lighting had stopped working on such lamps.^[9] The order concluded:

We therefore decline to provide the requested relief from the Satellite Radio Licensees to prohibit operation of all RF lights in the 2.45 GHz band, as we find that the requested prohibition is overarching and is not warranted based on the circumstances. If there is evidence that any entity will seek to operate RF lights in the 2.45 GHz band and cause harmful interference to satellite radio receivers as a consequence, and our existing limits prove inadequate, we will at that time take appropriate action.

19.5 Environmental issues

Unlike fluorescent and high-intensity discharge lamps, sulfur lamps contain no mercury. Therefore, sulfur lamps do not pose a threat to the environment nor require special disposal. In addition, use of sulfur lamps has the potential to reduce the total amount of energy required for lighting.

19.6 Light distribution systems

Because the amount of light produced from one bulb is so great, it is usually necessary to distribute the light to areas far removed from the lamp. The most common method used is light pipes.

19.6.1 Light pipes

Main article: Light tube

The 3M light pipe is a long, transparent, hollow cylinder with a prismatic surface developed by 3M that distributes the light uniformly over its length.^[10] Light pipes can be as long as 40 metres (130 ft) and are assembled on site from shorter, modular units. The light pipe is attached to the parabolic reflector of the sulfur lamp. For shorter pipes, there will be a mirror at the opposite end; for longer ones, there will be a lamp at each end. The overall appearance of a light pipe has been compared to that of a giant-sized fluorescent tube. One sulfur lamp with a light pipe can replace dozens of HID lamps. In the National Air and Space Museum, three lamps, each with a 27-metre (89 ft) pipe, replaced 94 HID lamps while greatly increasing the amount of light delivered.^[3]

The greatly reduced number of lamps may simplify maintenance and reduce installation costs but may also require



Sulfur lamps with light pipes on the ceiling of the U.S. Air and Space Museum in Washington, D.C.

a backup system for areas where lighting is critical. The light pipes allow the lamp to be placed in an easily accessible area for maintenance and away from places where the heat of the lamp may be a problem.

19.6.2 Secondary reflectors

A secondary reflector is a structure with a mirrored surface placed directly into the path of the beam of light as it exits the parabolic primary reflector of the lamp. A secondary reflector can have a complex geometry which allows it to break up the light and direct it to where it is desired. It can spotlight an object or spread out the light for general illumination.

At Sundsvall-Härnösand Airport near Sundsvall, Sweden, airfield lighting is provided by sulfur lamps mounted on towers 30 metres tall. The lamps are directed upward and shine their light onto wing-shaped secondary reflectors that spread the light out and direct it downward. In this way, one lamp can illuminate an area 30 by 80 metres (100 by 260 ft).

At the headquarters of DONG Energy, an energy company in Denmark, a single sulfur lamp directs its light onto numerous specular reflectors and diffusers to illuminate the entrance hall as well as several sculptures outside of the building.

At the entrance to University Hospital in Lund, Sweden, secondary reflectors on the ceiling are clad with highly reflective films, but shaped so as to avoid any glare. Moreover, since these films have a microprismatic surface structure that splits up the beams, the risk of glare problems is further reduced. The fact that the reflectors move the light source far away from the eye of anyone who would happen to look into them helps to further eliminate glare problems.^[11]

19.6.3 Indirect lighting

Indirect fixtures direct most of their luminous flux upward toward a ceiling. A highly reflective ceiling can then serve as a secondary source of diffusive, low luminance, high visual quality lighting for interior spaces. The primary advantages of indirect lighting are the opportunity to significantly reduce indirect glare potential and to completely eliminate direct source viewing.^[12]

At the Sacramento Municipal Utility District (SMUD) headquarters building, two sulfur lamps were installed in the tops of free-standing kiosks. The 4.2-metre (13 ft 9 in) high ceiling was retrofit with high reflectance (90%), white acoustic ceiling tile. The lamps direct their light upward, and it is reflected off the ceiling providing indirect light. Narrow, medium, or wide beam patterns can be created by choosing various reflector elements.^[13]

19.6.4 Direct lighting

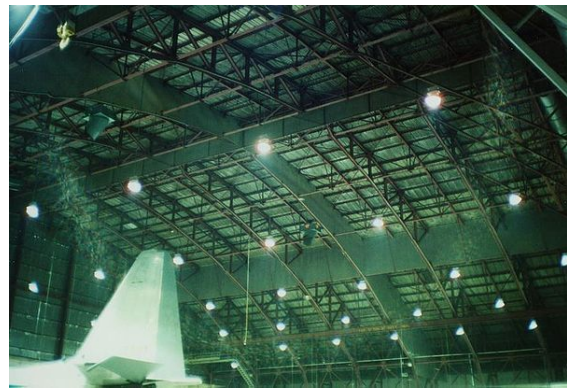

Hill AFB downlights

Light pipes would not be necessary in applications such as stadium lighting, where a plain fixture can be mounted high enough so that the light can spread over a large area. The installation at Hill Air Force Base contains lamps with light pipes as well as downlight fixtures mounted high in an aircraft hangar.

19.6.5 Optical fibers

Optical fibers have been studied as a distribution system for sulfur lamps, but no practical system has ever been marketed.^[14]

19.7 Other uses

Sulfur lamps can be used as light sources in scientific instruments.

19.8 Future prospects

The development of an affordable, efficient, and long-lived microwave source is a technological hurdle to cost reduction and commercial success. The lamp prototypes were only available in high wattages (1000+ W), which impeded adoption in applications where light output demands were not great. The sulfur lamp has problems with the life of the magnetron and the motor that rotates the bulb and noise from the cooling fan. Because most sulfur lamps have moving parts, reliability remains a critical issue, and system maintenance may impede market adoption, however newer-design lamps which no longer require active cooling are commercially available.^[2] Researchers have had some success at eliminating the need to rotate the bulb by using circularly polarized microwaves to spin the plasma discharge instead.^{[15][16]} Other experiments have used sodium iodide, scandium iodide, indium monobromide (InBr),^{[17][18]} or tellurium^[19] as the light-generating medium.

A patent #20070075617 is pending since 2006 for a sulfur lamp *with electrodes* — in fact, a more traditional gas-discharge lamp where a magnetron is not required. Various electrode coatings are suggested to combat high chemical activity of sulfur. As usual with patents, though, only commercial applications will reveal whether this design is viable.

19.9 Prominent installations

Main article: List of sulfur lamp installations

Many of the installations of the lamps were for testing



Air and Space Museum

purposes only, but there remain a few sites where the lamps are in use as the primary lighting source. Perhaps the most visible of these would be the glass atria in the National Air and Space Museum.

19.10 See also

- Electrodeless lamp
- Plasma lamp
- List of light sources
- Timeline of lighting technology

19.11 Notes

- [1] Compare this to 12–18 lumens per watt for conventional tungsten incandescent light bulbs.
- [2] “1000-watt sulfur lamp now ready”. *IAEEL newsletter* (1) (IAEEL). 1996. Archived from the original on Aug 18, 2003.
- [3] Frank A. Florentine. “The Next Generation of Lights: Electrodeless”. Palimpsest.stanford.edu. Retrieved 2014-09-19.
- [4] “NASA Tech Briefs - Sulfur Lamp With CaBr2 Additive for Enhanced Plant Growth”. Nasatech.com. July 1, 2000. Retrieved 2008-11-29.
- [5] “Donald A. MacLennan, Brian P. Turner, J.T.Dolan, M.G.Ury, & P.Gustafson - Efficient, Full-Spectrum, Long-Lived, Non-Toxic Microwave Lamp for Plant Growth”. Ncr101.montana.edu. Retrieved 2008-11-29.
- [6] http://science.empas.com/search/kisti_detail.html?q=%C3%B5%B0%F8+%B9%E6%BB%E7%C8%D6%B5%B5&i=40028&au=&rs=&jn=&m=T
- [7] <http://society.kisti.re.kr/~{ }society/image/kiee/1999/E01001033267.tif>
- [8] “IAEEL Newsletter 2/98”. Iael.org. Retrieved 2008-11-29.
- [9] “FCC Rejects Satellite Radio’s Petition to Ban RF Lights in 2.45 GHz Band”. *Radio World NewsBytes*. IMAS Publishing Group. November 16, 2004. Archived from the original on Feb 13, 2008. Retrieved Nov 29, 2008.
- [10] LightingResource.com, Online Reference Library for the Lighting Industry, <http://www.lightingresource.com>, <http://www.click2lighting.com>, <http://www.thelightingcenter.com>, <http://www.click2technology.com>. “Lighting Resource Product Searchcats33d0 - Light Pipe Lighting Fixtures - Lighting Resource - Category Display33”. Lightingresource.com. Retrieved 2008-11-29.
- [11] “IAEEL newsletter 4/94”. Iael.org. Retrieved 2008-11-29.
- [12] <http://btech.lbl.gov/papers/40506.pdf>
- [13] “A Sulfur Lamp and Fixture Demonstration at SMUD”. Eetd.lbl.gov. Archived from the original on November 14, 2007. Retrieved 2008-11-29.
- [14]

- [15] “Laser Focus World - Newsbreaks”. Lfw.pennnet.com. Retrieved 2008-11-29.
- [16] <http://scitation.aip.org/getabs/servlet/GetabsServlet?prog=normal&id=APPLAB000084000015002769000001&idtype=cvips&gifs=yes>
- [17] Electrodeless lamp mimics sunlight - 11/1/2000 - Design News
- [18] Masaya Shido; Tatsuya Nakamura; Takuya Serita; Hironobu Matsuo et al. (2003). “High-pressure Low-power Microwave Discharge using Annular Slot Antenna at the top of the Coaxial Tube”. Retrieved 2009-02-28.
- [19] “Microsoft Word - Environmental Friendly High Efficient Light Source.doc” (PDF). Archived from the original (PDF) on February 29, 2008. Retrieved 2008-11-29.

19.12 Further reading

- Suplee, Curt, “Energy Dept. Brings Dazzling Bulb to Light”, *The Washington Post*, October 21, 1994
- Suplee, Curt, “A New Kind of Illumination That Burns Brightly, but Not Out”, *The Washington Post*, October 24, 1994
- Holusha, John, “Light Source To Replace Many Bulbs”, *The New York Times*, October 26, 1994
- “Sulfur Lighting on Track”, *Environmental Building News*, July 1995
- Schroeder, Michael, and Dreazen, Yochi, “Energy-Saving Light Bulbs Mar Satellite Radio”, *The Wall Street Journal*, August 6, 2001
- “Sulfur Lighting No Longer on Track”, *Environmental Building News*, August 2005

Chapter 20

Electrodeless lamp



A round Induction lamp

The internal **electrodeless lamp** or **induction light** is a **gas discharge lamp** in which the power required to generate light is transferred from outside the lamp envelope to the gas inside via an **electric or magnetic field**, in contrast with a typical gas discharge lamp that uses internal **electrodes** connected to the power supply by conductors that pass through the lamp envelope. There are three advantages to elimination of the internal electrodes:

- Extended lamp life, because the internal electrodes are usually the limiting factor in lamp life.
- The ability to use light-generating substances of higher efficiency that would react with internal metal electrodes in normal lamps.
- Improved collection efficiency because the source can be made very small without shortening life, a problem in internal electroded lamps.

Two systems are described below – plasma lamps, which use electrostatic induction to energize a bulb filled with sulfur vapor or metal halides, and fluorescent induction lamps, based upon a conventional fluorescent lamp bulb in which current is induced by an external coil of wire via electrodynamic induction.

20.1 History

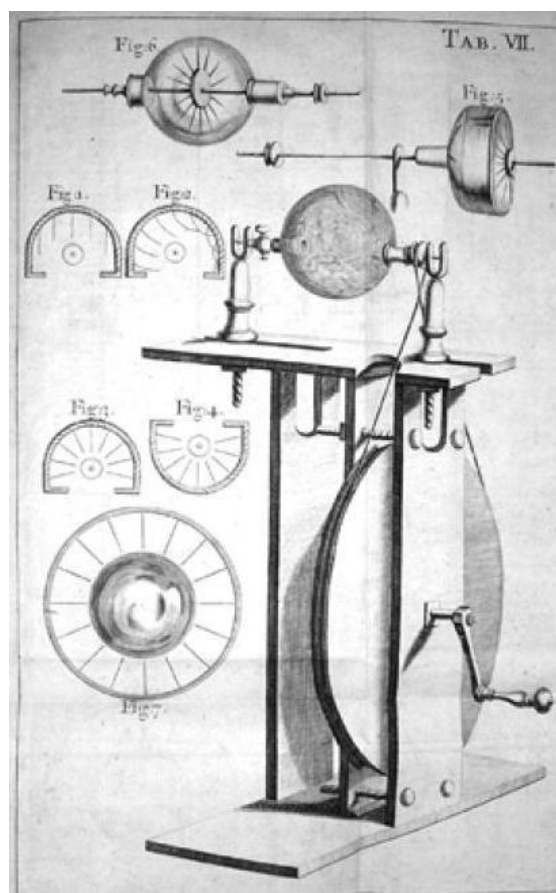

Generator built by Francis Hauksbee, from Physico-Mechanical Experiments, 2nd Ed., London 1719

In 1705, the scientist **Francis Hauksbee** demonstrated that in a rotating glass globe with internal vacuum like in a barometer, filled with mercury, and **statically charged** by holding a hand against the rotating globe, a light phenomenon occurred, so bright that one could read a paper.

Nikola Tesla demonstrated wireless transfer of power to electrodeless lamps in his lectures and articles in the 1890s, and subsequently patented a system of light and power distribution on those principles.^[1]

In 1967 and 1968, **John Anderson** of General Elec-

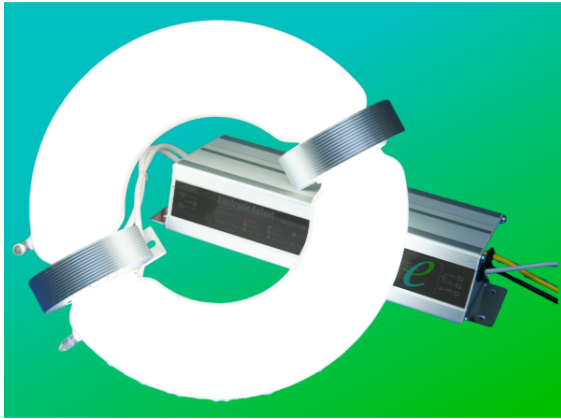

Example of a round 150 W magnetic induction lamp

tric^{[2][3]} applied for patents for electrodeless lamps. In 1971, Fusion UV Systems installed a 300-watt electrodeless microwave plasma UV lamp on a Coors can production line.^[4] Philips introduced their *QL* induction lighting systems, operating at 2.65 MHz, in 1990 in Europe and in 1992 in the US. Matsushita had induction light systems available in 1992. Intersource Technologies also announced one in 1992, called the *E-lamp*. Operating at 13.6 MHz, it was to be available on the US market in 1993.

In 1990, Michael Ury, Charles Wood and colleagues formulated the concept of the sulphur lamp. With support from the United States Department of Energy, it was further developed in 1994 by Fusion Lighting of Rockville, Maryland, a spinoff of the Fusion UV division of Fusion Systems Corporation. Its origins are in microwave discharge light sources used for ultraviolet curing in the semiconductor and printing industries.

Since 1994, General Electric has produced its induction lamp *Genura* with an integrated ballast, operating at 2.65 MHz. In 1996, Osram started selling their *Endura* induction light system, operating at 250 kHz. It is available in the US as the Sylvania *Icetron*. In 1997, PQL Lighting introduced in the US the *Superior Life Brand* induction lighting systems. Most induction lighting systems are rated for 100,000 hours of use before requiring absolute component replacements.

In 2005, Amko Solara in Taiwan introduced induction lamps that can dim and use IP (Internet Protocol) based controls. Their lamps have a range from 12 to 400 watts and operate at 250 kHz.

From 1995, the former distributors of Fusion, Jenton / Jenact, expanded on the fact that energised UV-emitting plasmas act as lossy conductors to create a number of patents regarding electrodeless UV lamps for sterilising and germicidal uses.

Around 2000, a system was developed that concentrated radio frequency waves into a solid dielectric waveguide made of ceramic which energized a light-emitting plasma

in a bulb positioned inside. This system, for the first time, permitted an extremely bright and compact electrodeless lamp. The invention has been a matter of dispute. Claimed by Frederick Espiau (then of Luxim, now of Topanga Technologies), Chandrashekhar Joshi and Yian Chang, these claims were disputed by Ceravision Limited.^[5] A number of the core patents were assigned to Ceravision.^{[6][7]}

In 2006, Luxim introduced a projector lamp product trade-named LIFI. The company further extended the technology with light source products in instrument, entertainment, street, area and architectural lighting applications among others throughout 2007 and 2008.

In 2009, Ceravision Limited introduced the first High Efficiency Plasma (HEP) lamp under the trade name Alvara. This lamp replaces the opaque ceramic waveguide used in earlier lamps with an optically clear quartz waveguide giving greatly increased efficiency. In previous lamps, though the burner, or bulb, was very efficient, the opaque ceramic waveguide severely obstructed the collection of light. A quartz waveguide allows all of the light from the plasma to be collected.

In 2012, Topanga Technologies introduced a line of advanced plasma lamps (APL), driven by a solid state radio frequency (RF) driver,^[8] thereby circumventing the limited life of magnetron-based drivers, with system power of 127 and 230 watts and system efficacies of 96 and 87 lumen/watt, with a CRI of about 70.

20.2 Plasma lamps

Main article: Plasma lamp

Plasma lamps are a family of light sources that generate light by exciting a plasma inside a closed transparent burner or bulb using radio frequency (RF) power. Typically, such lamps use a noble gas or a mixture of these gases and additional materials such as metal halides, sodium, mercury or sulfur. A waveguide is used to constrain and focus the electrical field into the plasma. In operation the gas is ionized and free electrons, accelerated by the electrical field, collide with gas and metal atoms. Some electrons circling around the gas and metal atoms are excited by these collisions, bringing them to a higher energy state. When the electron falls back to its original state, it emits a photon, resulting in visible light or ultraviolet radiation depending on the fill materials.

The first plasma lamp was an ultraviolet curing lamp with a bulb filled with argon and mercury vapor developed by Fusion UV. That lamp led Fusion Systems to the development of the sulfur lamp, a bulb filled with argon and sulfur which is bombarded with microwaves through a hollow waveguide.

In the past, the reliability of the technology was limited

by the **magnetron** used to generate the microwaves. Solid state RF generation can be used and gives long life. However, using solid state chips to generate RF is approximately fifty times more expensive currently than using a **magnetron** and so only appropriate for high value lighting niches. It has recently been shown by Dipolar of Sweden to be possible to greatly extend the life of **magnetrons** to over 40,000 hours^[9] making low cost plasma lamps possible. Plasma lamps are currently produced by **Ceravision** and **Luxim** and in development by **Topanga Technologies**.

Ceravision has introduced a combined lamp and luminaire under the trade name *Alvara* for use in high bay and street lighting applications. It uses an optically clear quartz waveguide with an integral burner allowing all the light from the plasma to be collected. The small source also allows the luminaire to utilize more than 90% of the available light compared with 55% for typical HID fittings. **Ceravision** claims the highest Luminaire Efficacy Rating (LER)^[10] of any light fitting on the market and to have created the first High Efficiency Plasma (HEP) lamp. **Ceravision** uses a **magnetron** to generate the required RF power and claim a life of 20,000 hours.

Luxim's Li-Fi lamp, claims 120 lumens per RF watt (i.e. before taking into account electrical losses).^[11] The lamp has been used in **Robe lighting's** *ROBIN 300 Plasma Spot* moving headlight.^[12] It was also used in a line of, now discontinued, **Panasonic** rear projection TVs.^[13]

20.3 Magnetic induction lamps

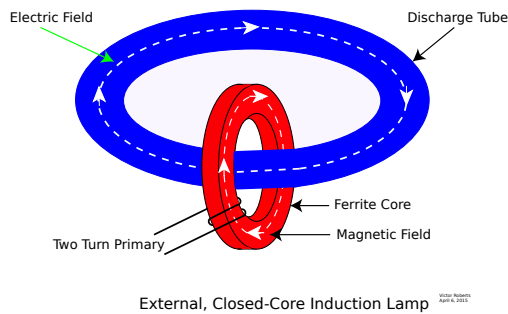

External Closed Core Induction Lamp with Two Turn Primary

Aside from the method of **coupling** energy into the mercury vapor, these lamps are very similar to conventional **fluorescent lamps**. Mercury vapor in the discharge vessel is electrically excited to produce short-wave ultraviolet light, which then excites internal **phosphors** to produce visible light. While still relatively unknown to the public, these lamps have been available since 1990. Unlike an incandescent lamp or conventional fluorescent lamps, there is no **electrical connection** going inside the glass bulb; the energy is transferred *through* the glass envelope solely by **electromagnetic induction**.

There are two main types of magnetic induction lamps:

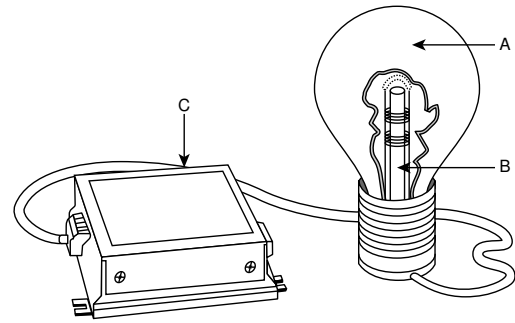

A Philips QL induction lighting system, where (A) Discharge vessel, (B) Tube with power coupler and (C) Electronic ballast.

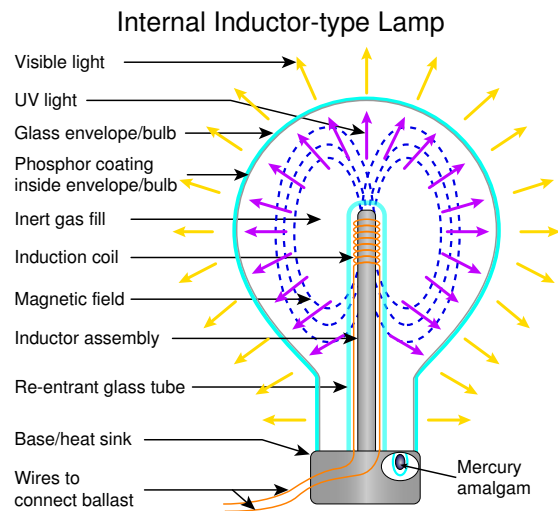

Cross section through internal inductor lamp

external core lamps and internal core lamps. The first commercially-available and still widely used form of induction lamp is the internal core type. The external core type, which was commercialized later, has a wider range of applications and is available in round, rectangular and “olive” shaped form factors.

External core lamps are basically fluorescent lamps with magnetic cores wrapped around a part of the discharge tube. The core is usually made of **ferrite**, a ceramic material containing iron oxide and other metals. In external core lamps, high frequency energy from a special power supply called an electronic ballast is sent through wires that are wrapped in a coil around a toroidal **ferrite core** placed around the outside of a portion of the glass tube, creating a high frequency magnetic field within the ferrite core. Since the **magnetic permeability** of the ferrite is hundreds or thousands of times higher than that of the surrounding air or glass, and the ferrite core provides a closed path for the magnetic field, virtually all of the magnetic field is contained inside the ferrite core. As shown in **Faraday's law of induction**, the time varying magnetic field in the core will generate a time varying electric voltage in any closed path that encloses the time varying mag-

netic field. The discharge tube forms one such closed path around the ferrite core, and in that manner the time varying magnetic field in the core generates a time varying electric field in the discharge tube. There is no need for the magnetic field to penetrate the discharge tube. The electric field generated by the time varying magnetic field drives the mercury-rare gas discharge in the same way the discharge is driven by the electric field in a conventional fluorescent lamp. The primary winding on the ferrite core, the core, and the discharge form a transformer, with the discharge being a one-turn secondary on that transformer.

The discharge tube contains a low pressure of a rare gas such as argon and mercury vapor. The mercury atoms are provided by a drop of liquid mercury or by a semi-solid amalgam of mercury and other metals such as bismuth, lead or tin. Some of the liquid mercury or the mercury in the amalgam vaporizes to provide the mercury vapor. The electric field ionizes some of the mercury atoms to produce free electrons, and then accelerates those free electrons. When the free electrons collide with mercury atoms, some of those atoms absorb energy from the electrons and are “excited” to higher energy levels. After a short delay, the excited mercury atoms spontaneously relax to their original lower energy state and emit a UV photon with the excess energy. As in a conventional fluorescent tube, the UV photon diffuses through the gas to the inside of the outer bulb, and is absorbed by the phosphor coating that surface, transferring its energy to the phosphor. When the phosphor then relaxes to its original, lower energy state, it emits visible light. In this way the UV photon is down-converted to visible light by the phosphor coating on the inside of the tube. The glass walls of the lamp prevent the emission of the UV photons because ordinary glass blocks UV radiation at the 253.7 nm and shorter wavelengths.

In the internal core form (see diagram), a glass tube (B) protrudes bulb-wards from the bottom of the discharge vessel (A), forming a re-entrant cavity. This tube contains an antenna called a *power coupler*, which consists of a coil wound over a cylindrical ferrite core. The coil and ferrite forms the inductor which couples the energy into the lamp interior

The antenna coils receive electric power from the electronic ballast (C) that generates a high frequency. The exact frequency varies with lamp design, but popular examples include 13.6 MHz, 2.65 MHz and 250 kHz. A special resonant circuit in the ballast produces an initial high voltage on the coil to start a gas discharge; thereafter the voltage is reduced to normal running level.

The system can be seen as a type of transformer, with the power coupler (inductor) forming the primary coil and the gas discharge arc in the bulb forming the one-turn secondary coil and the load of the transformer. The ballast is connected to mains electricity, and is generally designed to operate on voltages between 100 and 277 VAC at a fre-

quency of 50 or 60 Hz, or on a voltage between 100 and 400 VDC for battery fed emergency light systems. Many ballasts are available in low voltage models so can also be connected to DC voltage sources like batteries for emergency lighting purposes or for use with renewable energy (solar & wind) powered systems.

In other conventional gas discharge lamps, the electrodes are the part with the shortest life, limiting the lamp lifespan severely. Since an induction lamp has no electrodes, it can have a very long service life. For induction lamp systems with a separate ballast, the service life can be as long as 100,000 hours, which is 11.4 years continuous operation. For induction lamps with integrated ballast, the lifespan is in the 15,000 to 50,000 hours range. Extremely high-quality electronic circuits are needed for the ballast to attain such a long service life. Such lamps are typically used in commercial or industrial applications. Typically operations and maintenance costs are significantly lower with induction lighting systems due to their industry average 100,000 hour life cycle and five to ten year warranty.

20.3.1 Advantages



The London landmark Big Ben. The clock face is lit by Electrodeless lamps.

- Long lifespan due to the lack of electrodes – Strictly speaking almost indefinite on the lamp itself but between 25,000 and 100,000 hours depending on lamp model and quality of electronics used;
- Very high energy conversion efficiency of between 62 and 90 Lumens/Watt [higher power lamps are more energy efficient];
- High power factor due to the low loss of the high frequency electronic ballasts which are typically between 95% and 98% efficient;
- Minimal Lumen depreciation (declining light output with age) compared to other lamp types as filament evaporation and depletion is absent;
- “Instant-on” and hot re-strike, unlike most HID lamps used in commercial-industrial lighting applications (such as mercury-vapor lamp, sodium-vapor lamp and metal halide lamp);
- Environmentally friendly as induction lamps use less energy, and use less mercury per hour of operation than conventional lighting due to their long lifespan. The mercury is in a solid form and can be easily recovered if the lamp is broken, or for recycling at end-of-life.

These benefits offer considerable cost savings of between 35% and 55% in energy and maintenance costs for induction lamps compared to other types of commercial and industrial lamps which they replace.

20.3.2 Disadvantages

- Some models of internal inductor lamps that use high frequency ballasts can produce radio frequency interference (RFI) which interferes with radio communications in the area. Newer, external inductor type lamps use low frequency ballasts that usually have FCC or other certification, thus complying with RFI regulations.
- External inductor lamps tend to be quite large, especially in higher wattage models, thus they are not always suitable for applications where a compact light source is required.
- Some types of inductor lamps contain mercury, which is highly toxic if released to the environment.

20.4 See also

- List of light sources
- Induction cooker

20.5 References

- [1] “Experiments with Alternate Currents of Very High Frequency and Their Application to Methods of Artificial Illumination”, AIEE, Columbia College, N.Y., May 20, 1891
- [2] Electrodeless gaseous electric discharge devices utilizing ferrite cores
- [3] High frequency electrodeless fluorescent lamp assembly
- [4] <http://www.fusionuv.com/history.aspx>
- [5] Ceravision Steps up Legal Action Against Luxim to Recover IP
- [6] Microwave Energized Plasma Lamp with Solid Dielectric Waveguide
- [7] Plasma Lamp with Dielectric Waveguide
- [8] <http://topangatech.com/>
- [9] <http://www.prnewswire.com/news-releases/ceravision--dipolar-form-global-alliance-to-take-ultra-efficient-lighting-tech.html>
- [10] Procedure for Determining Luminaire Efficacy Ratings for High-Intensity Discharge (HID) Industrial Luminaires
- [11] “A lightbulb powered by radio waves”. cnet. 2007-08-23.
- [12] “Robe Launches ROBIN 300 Plasma Spot”. Robe lighting. 2009-04-27.
- [13] “The gift of LIFI: Panasonic projection TVs don't burn out”. cnet. 2007-01-09.

20.6 External links

- Examples of Electrodeless lamps
- Super high efficiency method for cathodeless lamp excitation - The radioluminescence effect in the HF spectrum of radio waves

Chapter 21

Electric light



Colored lights illuminating the Monks' cellarium, Fountains Abbey

For other uses, see [Electric light \(disambiguation\)](#).

An **electric light** is a device that produces visible light by the flow of electric current. It is the most common form of artificial lighting and is essential to modern society, providing interior lighting for buildings and exterior light for evening and nighttime activities. Before electric lighting became common in the early 20th century, people used candles, gas lights, oil lamps, and fires. Most electric lighting is powered by centrally generated electric power, but lighting may also be powered by mobile or standby electric generators or battery systems. Battery-powered lights, usually called "flashlights" or "torches", are used for portability and as backups when the main lights fail.

The two main categories of electric lights are *incandescent lamps*, which produce light by a filament heated white-hot by electric current, and *gas-discharge lamps*, which produce light by means of an electric arc through a gas. The energy efficiency of electric lighting has increased radically since the first demonstration of arc lamps and the incandescent light bulb of the 19th century. Modern electric light sources come in a profusion of types and sizes adapted to a myriad of applications. The word "lamp" can refer either to a light source or an or the appliance that holds the source.

21.1 Types

Types of electric lighting include:

- incandescent light bulbs
- arc lamps
- gas-discharge lamps, e.g., fluorescent lights and compact fluorescent lamps, neon lamps, flood lamps, modern photographic flashes
- lasers
- light-emitting diodes, including OLEDs
- sulfur lamps

Different types of lights have vastly differing efficiencies and color of light.

*Color temperature is defined as the temperature of a black body emitting a similar spectrum; these spectra are quite different from those of black bodies.

The most efficient source of electric light is the low-pressure sodium lamp. It produces, for all practical purposes, a monochromatic orange/yellow light, which gives a similarly monochromatic perception of any illuminated scene. For this reason, it is generally reserved for outdoor public lighting usages. Low-pressure sodium lights are favoured for public lighting by astronomers, since the light pollution that they generate can be easily filtered, contrary to broadband or continuous spectra.

21.1.1 Incandescent light bulb

Main article: [Incandescent light bulb](#)

The modern incandescent lightbulb, with a coiled filament of tungsten, was commercialized in the 1920s developed from the carbon filament lamp introduced in about 1880. As well as bulbs for normal illumination, there is a very wide range, including low voltage, low-power types often used as components in equipment, but now largely displaced by LEDs

There is currently interest in banning some types of filament lamp in some countries, such as Australia planning to ban standard incandescent light bulbs by 2010, because they are inefficient at converting electricity to light. Sri Lanka has already banned importing filament bulbs because of high use of electricity and less light. Less than 3% of the input energy is converted into usable light. Nearly all of the input energy ends up as heat that, in warm climates, must then be removed from the building by ventilation or air conditioning, often resulting in more energy consumption. In colder climates where heating and lighting is required during the cold and dark winter months, the heat byproduct has at least some value.

Halogen lamp

Main article: [Halogen lamp](#)

Halogen lamps are usually much smaller than standard incandescents, because for successful operation a bulb temperature over 200 °C is generally necessary. For this reason, most have a bulb of fused silica (quartz), but sometimes aluminosilicate glass. This is often sealed inside an additional layer of glass. The outer glass is a safety precaution, reducing UV emission and because halogen bulbs can occasionally explode during operation. One reason is if the quartz bulb has oily residue from fingerprints. The risk of burns or fire is also greater with bare bulbs, leading to their prohibition in some places unless enclosed by the luminaire.

Those designed for 12 V or 24 V operation have compact filaments, useful for good optical control, also they have higher efficiencies (lumens per watt) and better lives than non halogen types. The light output remains almost constant throughout life.

21.1.2 Fluorescent lamp

Main article: [Fluorescent lamp](#)

Fluorescent lamps consist of a glass tube that contains mercury vapour or argon under low pressure. Electricity flowing through the tube causes the gases to give off ultraviolet energy. The inside of the tubes are coated with phosphors that give off visible light when struck by ultraviolet energy.^[1] have much higher efficiency than Incandescent lamps. For the same amount of light generated, they typically use around one-quarter to one-third the power of an incandescent.

21.1.3 LED lamp

Main article: [Solid-state lighting](#)

Solid state LEDs have been popular as indicator lights since the 1970s. In recent years, efficacy and output have risen to the point where LEDs are now being used in niche lighting applications.

Indicator LEDs are known for their extremely long life, up to 100,000 hours, but lighting LEDs are operated much less conservatively (due to high LED cost per watt), and consequently have much shorter lives.

Due to the relatively high cost per watt, LED lighting is most useful at very low powers, typically for lamp assemblies of under 10 W. LEDs are currently most useful and cost-effective in low power applications, such as nightlights and flashlights. Colored LEDs can also be used for accent lighting, such as for glass objects, and even in fake ice cubes for drinks at parties. They are also being increasingly used as holiday lighting.

LED efficiencies vary over a very wide range. Some have lower efficiency than filament lamps, and some significantly higher. LED performance in this respect is prone to being misinterpreted, as the inherent directionality of LEDs gives them a much higher light intensity in one direction per given total light output.

Single color LEDs are well developed technology, but white LEDs at time of writing still have some unresolved issues.

1. CRI is not particularly good, resulting in less than accurate color rendition.
2. The light distribution from the phosphor does not fully match the distribution of light from the LED die, so color temperature varies at differing angles.
3. Phosphor performance degrades over time, resulting in change of color temperature and falling output. With some LEDs degradation can be quite fast.
4. Limited heat tolerance means that the amount of power packable into a lamp assembly is a fraction of the power usable in a similarly sized incandescent lamp.

LED technology is useful for lighting designers because of its low power consumption, low heat generation, instantaneous on/off control, and in the case of single color LEDs, continuity of color throughout the life of the diode and relatively low cost of manufacture.

In the last few years, software has been developed to merge lighting and video by enabling lighting designers to stream video content to their LED fixtures, creating low resolution video walls.

For general domestic lighting, total cost of ownership of LED lighting is still much higher than for other well established lighting types.

21.1.4 Carbon arc lamp

Main article: [Arc lamp](#)

Carbon arc lamps consist of two carbon rod electrodes in open air, supplied by a current-limiting ballast. The electric arc is struck by touching the rods then separating them. The ensuing arc heats the carbon tips to white heat. These lamps have higher efficiency than filament lamps, but the carbon rods are short lived and require constant adjustment in use. The lamps produce significant ultraviolet output, they require ventilation when used indoors, and due to their intensity they need protecting from direct sight.

Invented by [Humphry Davy](#) around 1805, the carbon arc was the first practical electric light. They were used commercially beginning in the 1870s for large building and street lighting until they were superseded in the early 20th century by the incandescent light. Carbon arc lamps operate at high powers and produce high intensity white light. They also are a point source of light. They remained in use in limited applications that required these properties, such as [movie projectors](#), [stage lighting](#), and [searchlights](#), until after World War 2.

21.1.5 Discharge lamp

A **discharge lamp** has a glass or silica envelope containing two metal electrodes separated by a gas. Gases used include, neon, argon, xenon, sodium, metal halide, and mercury.

The core operating principle is much the same as the carbon arc lamp, but the term 'arc lamp' is normally used to refer to carbon arc lamps, with more modern types of gas discharge lamp normally called discharge lamps.

With some discharge lamps, very high voltage is used to strike the arc. This requires an electrical circuit called an igniter, which is part of the ballast circuitry. After the arc is struck, the internal resistance of the lamp drops to a low level, and the ballast limits the current to the operating current. Without a ballast, excess current would flow, causing rapid destruction of the lamp.

Some lamp types contain a little neon, which permits striking at normal running voltage, with no external ignition circuitry. Low pressure sodium lamps operate this way.

The simplest ballasts are just an inductor, and are chosen where cost is the deciding factor, such as street lighting. More advanced electronic ballasts may be designed to maintain constant light output over the life of the lamp, may drive the lamp with a square wave to maintain completely flicker-free output, and shut down in the event of certain faults.

21.2 Lamp life expectancy

Life expectancy is defined as the number of hours of operation for a lamp until 50% of them fail. This means that it is possible for some lamps to fail after a short amount of time and for some to last significantly longer than the rated lamp life. This is an average (median) life expectancy. Production tolerances as low as 1% can create a variance of 25% in lamp life. For LEDs, lamp life is when 50% of lamps have lumen output drop to 70% or less.

Lamps are also sensitive to switching cycles. The rapid heating of a lamp filament or electrodes when a lamp is turned on is the most stressful event on the lamp. Most test cycles have the lamps on for 3 hours and then off for 20 minutes. (Some standard had to be used since it is unknown how the lamp will be used by consumers.) This switching cycle repeats until the lamps fail and the data is recorded. If switching is increased to only 1 hour on, the lamp life is usually reduced because the number of times the lamp has been turned on has increased. Rooms with frequent switching (bathroom, bedrooms, etc.) can expect much shorter lamp life than what is printed on the box.

21.3 Public lighting

The total amount of artificial light (especially from [street light](#)) is sufficient for cities to be easily visible at night from the air, and from space. This light is the source of [light pollution](#) that burdens astronomers and others.

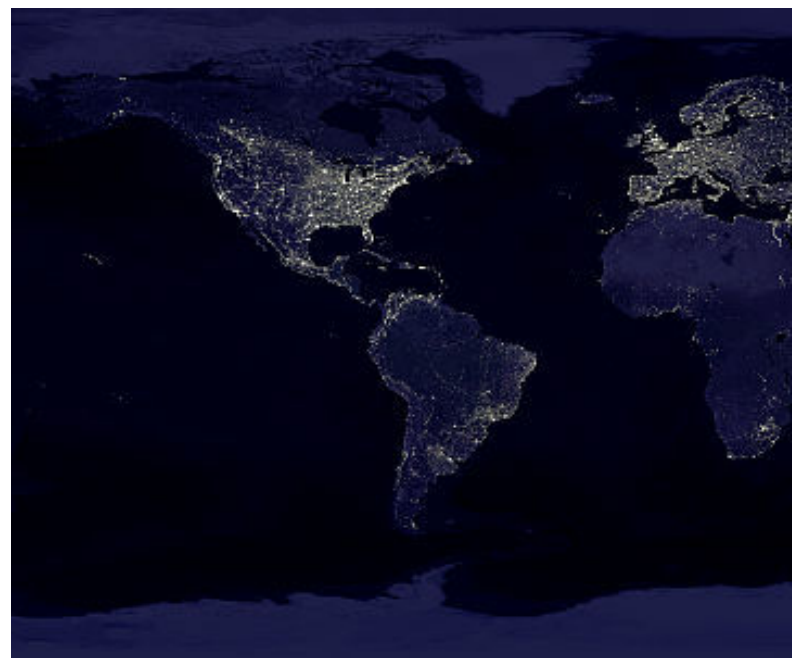

Human-made lights highlight particularly developed or populated areas of the Earth's surface, including the seabords of Europe, the eastern United States, Japan and South Korea.

21.4 See also

- List of light sources

21.5 References

- [1] Perkowitz, Sidney; Henry, A. Joseph (23 November 1998). *Empire of Light:: A History of Discovery in Science and Art*. Joseph Henry Press. ISBN 978-0309065566. Retrieved 4 November 2014.

Chapter 22

OLED

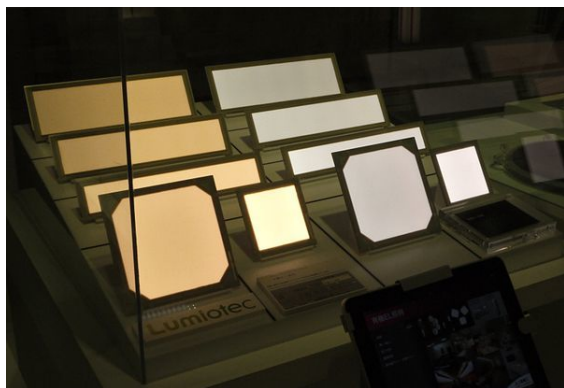

Prototype OLED lighting panels

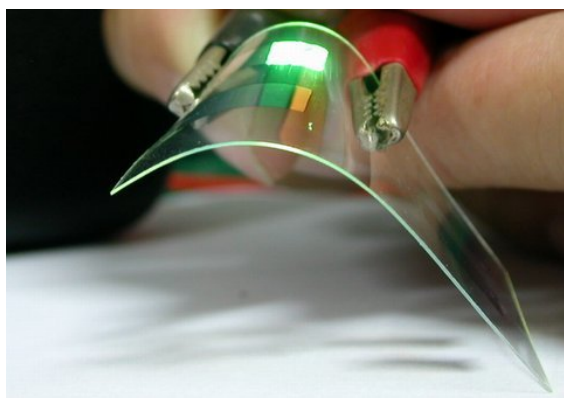

Demonstration of a flexible OLED device

An **organic light-emitting diode (OLED)** is a light-emitting diode (LED) in which the emissive electroluminescent layer is a film of organic compound which emits light in response to an electric current. This layer of organic semiconductor is situated between two electrodes; typically, at least one of these electrodes is transparent. OLEDs are used to create digital displays in devices such as television screens, computer monitors, portable systems such as mobile phones, handheld game consoles and PDAs. A major area of research is the development of white OLED devices for use in solid-state lighting applications.^{[1][2][3]}

There are two main families of OLED: those based on small molecules and those employing polymers. Adding



OLED TV

mobile ions to an OLED creates a light-emitting electrochemical cell (LEC) which has a slightly different mode of operation. OLED displays can use either passive-matrix (PMOLED) or active-matrix addressing schemes. Active-matrix OLEDs (AMOLED) require a thin-film transistor backplane to switch each individual pixel on or off, but allow for higher resolution and larger display sizes.

An OLED display works without a backlight; thus, it can display deep black levels and can be thinner and lighter than a liquid crystal display (LCD). In low ambient light conditions (such as a dark room), an OLED screen can achieve a higher contrast ratio than an LCD, regardless of whether the LCD uses cold cathode fluorescent lamps or an LED backlight.

22.1 History

The first observations of electroluminescence in organic materials were in the early 1950s by André Bernanose and co-workers at the Nancy-Université in France. They applied high alternating voltages in air to materials such as acridine orange, either deposited on or dissolved in cellulose or cellophane thin films. The proposed mechanism was either direct excitation of the dye molecules or excitation of electrons.^{[4][5][6][7]}

In 1960, Martin Pope and some of his co-workers at New York University developed ohmic dark-injecting electrode contacts to organic crystals.^{[8][9][10]} They further

described the necessary energetic requirements (work functions) for hole and electron injecting electrode contacts. These contacts are the basis of charge injection in all modern OLED devices. Pope's group also first observed direct current (DC) electroluminescence under vacuum on a single pure crystal of anthracene and on anthracene crystals doped with tetracene in 1963^[11] using a small area silver electrode at 400 volts. The proposed mechanism was field-accelerated electron excitation of molecular fluorescence.

Pope's group reported in 1965^[12] that in the absence of an external electric field, the electroluminescence in anthracene crystals is caused by the recombination of a thermalized electron and hole, and that the conducting level of anthracene is higher in energy than the exciton energy level. Also in 1965, W. Helfrich and W. G. Schneider of the National Research Council in Canada produced double injection recombination electroluminescence for the first time in an anthracene single crystal using hole and electron injecting electrodes,^[13] the forerunner of modern double injection devices. In the same year, Dow Chemical researchers patented a method of preparing electroluminescent cells using high voltage (500–1500 V) AC-driven (100–3000 Hz) electrically insulated one millimetre thin layers of a melted phosphor consisting of ground anthracene powder, tetracene, and graphite powder.^[14] Their proposed mechanism involved electronic excitation at the contacts between the graphite particles and the anthracene molecules.

Electroluminescence from polymer films was first observed by Roger Partridge at the National Physical Laboratory in the United Kingdom. The device consisted of a film of poly(N-vinylcarbazole) up to 2.2 micrometres thick located between two charge injecting electrodes. The results of the project were patented in 1975^[15] and published in 1983.^{[16][17][18][19]}

The first diode device was reported at Eastman Kodak by Ching W. Tang and Steven Van Slyke in 1987.^[20] This device used a novel two-layer structure with separate hole transporting and electron transporting layers such that recombination and light emission occurred in the middle of the organic layer; this resulted in a reduction in operating voltage and improvements in efficiency that led to the current era of OLED research and device production.

Research into polymer electroluminescence culminated in 1990 with J. H. Burroughes *et al.* at the Cavendish Laboratory in Cambridge reporting a high efficiency green light-emitting polymer based device using 100 nm thick films of poly(p-phenylene vinylene).^[21]

Universal Display Corporation holds the majority of patents concerning the commercialization of OLEDs.

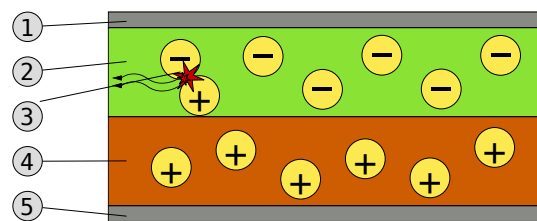

Schematic of a bilayer OLED: 1. Cathode (-), 2. Emissive Layer, 3. Emission of radiation, 4. Conductive Layer, 5. Anode (+)

22.2 Working principle

A typical OLED is composed of a layer of organic materials situated between two electrodes, the anode and cathode, all deposited on a substrate. The organic molecules are electrically conductive as a result of delocalization of pi electrons caused by conjugation over part or all of the molecule. These materials have conductivity levels ranging from insulators to conductors, and are therefore considered organic semiconductors. The highest occupied and lowest unoccupied molecular orbitals (HOMO and LUMO) of organic semiconductors are analogous to the valence and conduction bands of inorganic semiconductors.

Originally, the most basic polymer OLEDs consisted of a single organic layer. One example was the first light-emitting device synthesised by J. H. Burroughes *et al.*, which involved a single layer of poly(p-phenylene vinylene). However multilayer OLEDs can be fabricated with two or more layers in order to improve device efficiency. As well as conductive properties, different materials may be chosen to aid charge injection at electrodes by providing a more gradual electronic profile,^[22] or block a charge from reaching the opposite electrode and being wasted.^[23] Many modern OLEDs incorporate a simple bilayer structure, consisting of a conductive layer and an emissive layer. More recent developments in OLED architecture improves quantum efficiency (up to 19%) by using a graded heterojunction.^[24] In the graded heterojunction architecture, the composition of hole and electron-transport materials varies continuously within the emissive layer with a dopant emitter. The graded heterojunction architecture combines the benefits of both conventional architectures by improving charge injection while simultaneously balancing charge transport within the emissive region.^[25]

During operation, a voltage is applied across the OLED such that the anode is positive with respect to the cathode. Anodes are picked based upon the quality of their optical transparency, electrical conductivity, and chemical stability.^[26] A current of electrons flows through the device from cathode to anode, as electrons are injected into the LUMO of the organic layer at the cathode and withdrawn from the HOMO at the anode. This latter pro-

cess may also be described as the injection of **electron holes** into the HOMO. Electrostatic forces bring the electrons and the holes towards each other and they recombine forming an **exciton**, a bound state of the electron and hole. This happens closer to the emissive layer, because in organic semiconductors holes are generally more mobile than electrons. The decay of this excited state results in a relaxation of the energy levels of the electron, accompanied by emission of **radiation** whose **frequency** is in the **visible region**. The frequency of this radiation depends on the **band gap** of the material, in this case the difference in energy between the HOMO and LUMO.

As electrons and holes are fermions with half integer spin, an exciton may either be in a **singlet state** or a **triplet state** depending on how the spins of the electron and hole have been combined. Statistically three triplet excitons will be formed for each singlet exciton. Decay from triplet states (**phosphorescence**) is spin forbidden, increasing the timescale of the transition and limiting the internal efficiency of fluorescent devices. **Phosphorescent organic light-emitting diodes** make use of **spin-orbit interactions** to facilitate **intersystem crossing** between singlet and triplet states, thus obtaining emission from both singlet and triplet states and improving the internal efficiency.

Indium tin oxide (ITO) is commonly used as the anode material. It is transparent to visible light and has a high work function which promotes injection of holes into the HOMO level of the organic layer. A typical conductive layer may consist of PEDOT:PSS^[27] as the HOMO level of this material generally lies between the work-function of ITO and the HOMO of other commonly used polymers, reducing the energy barriers for hole injection. Metals such as barium and calcium are often used for the cathode as they have low work functions which promote injection of electrons into the LUMO of the organic layer.^[28] Such metals are reactive, so they require a capping layer of aluminium to avoid degradation.

Experimental research has proven that the properties of the anode, specifically the anode/hole transport layer (HTL) interface topography plays a major role in the efficiency, performance, and lifetime of organic light emitting diodes. Imperfections in the surface of the anode decrease anode-organic film interface adhesion, increase electrical resistance, and allow for more frequent formation of non-emissive dark spots in the OLED material adversely affecting lifetime. Mechanisms to decrease anode roughness for ITO/glass substrates include the use of thin films and self-assembled monolayers. Also, alternative substrates and anode materials are being considered to increase OLED performance and lifetime. Possible examples include single crystal sapphire substrates treated with gold (Au) film anodes yielding lower work functions, operating voltages, electrical resistance values, and increasing lifetime of OLEDs.^[29]

Single carrier devices are typically used to study the

kinetics and charge transport mechanisms of an organic material and can be useful when trying to study energy transfer processes. As current through the device is composed of only one type of charge carrier, either electrons or holes, recombination does not occur and no light is emitted. For example, electron only devices can be obtained by replacing ITO with a lower work function metal which increases the energy barrier of hole injection. Similarly, hole only devices can be made by using a cathode made solely of aluminium, resulting in an energy barrier too large for efficient electron injection.^{[30][31][32]}

22.3 Material technologies

22.3.1 Small molecules

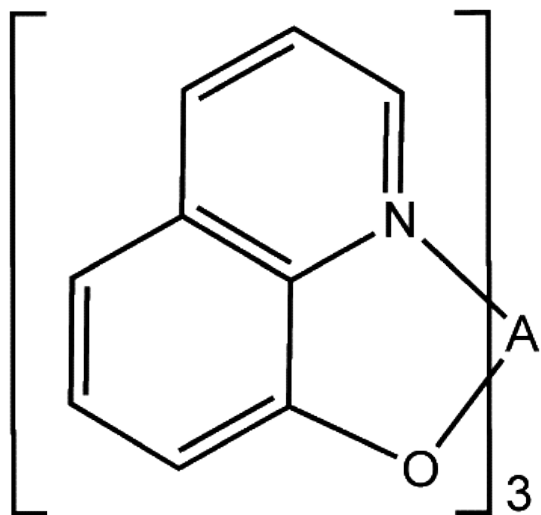

Alq₃,^[20] commonly used in small molecule OLEDs

Efficient OLEDs using small molecules were first developed by Dr. Ching W. Tang *et al.*^[20] at Eastman Kodak. The term OLED traditionally refers specifically to this type of device, though the term SM-OLED is also in use.

Molecules commonly used in OLEDs include organometallic chelates (for example Alq₃, used in the organic light-emitting device reported by Tang *et al.*), fluorescent and phosphorescent dyes and conjugated dendrimers. A number of materials are used for their charge transport properties, for example triphenylamine and derivatives are commonly used as materials for hole transport layers.^[33] Fluorescent dyes can be chosen to obtain light emission at different wavelengths, and compounds such as perylene, rubrene and quinacridone derivatives are often used.^[34] Alq₃ has been used as a green emitter, electron transport material and as a host for yellow and red emitting dyes.

The production of small molecule devices and displays usually involves thermal evaporation in a vacuum. This

makes the production process more expensive and of limited use for large-area devices than other processing techniques. However, contrary to polymer-based devices, the vacuum deposition process enables the formation of well controlled, homogeneous films, and the construction of very complex multi-layer structures. This high flexibility in layer design, enabling distinct charge transport and charge blocking layers to be formed, is the main reason for the high efficiencies of the small molecule OLEDs.

Coherent emission from a laser dye-doped tandem SM-OLED device, excited in the pulsed regime, has been demonstrated.^[35] The emission is nearly diffraction limited with a spectral width similar to that of broadband dye lasers.^[36]

Researchers report luminescence from a single polymer molecule, representing the smallest possible organic light-emitting diode (OLED) device.^[37] Scientists will be able to optimize substances to produce more powerful light emissions. Finally, this work is a first step towards making molecule-sized components that combine electronic and optical properties. Similar components could form the basis of a molecular computer.^[38]

22.3.2 Polymer light-emitting diodes

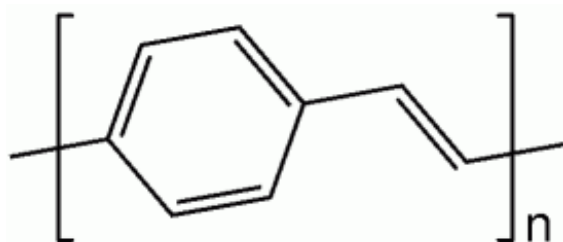

poly(p-phenylene vinylene), used in the first PLED^[21]

Polymer light-emitting diodes (PLED), also light-emitting polymers (LEP), involve an electroluminescent conductive polymer that emits light when connected to an external voltage. They are used as a thin film for full-spectrum colour displays. Polymer OLEDs are quite efficient and require a relatively small amount of power for the amount of light produced.

Vacuum deposition is not a suitable method for forming thin films of polymers. However, polymers can be processed in solution, and spin coating is a common method of depositing thin polymer films. This method is more suited to forming large-area films than thermal evaporation. No vacuum is required, and the emissive materials can also be applied on the substrate by a technique derived from commercial inkjet printing.^{[39][40]} However, as the application of subsequent layers tends to dissolve those already present, formation of multilayer structures is difficult with these methods. The metal cathode may still need to be deposited by thermal evaporation in vacuum. An alternative method to vacuum deposition is to

deposit a Langmuir-Blodgett film.

Typical polymers used in PLED displays include derivatives of poly(*p*-phenylene vinylene) and polyfluorene. Substitution of side chains onto the polymer backbone may determine the colour of emitted light^[41] or the stability and solubility of the polymer for performance and ease of processing.^[42]

While unsubstituted poly(*p*-phenylene vinylene) (PPV) is typically insoluble, a number of PPVs and related poly(naphthalene vinylene)s (PNVs) that are soluble in organic solvents or water have been prepared via ring opening metathesis polymerization.^{[43][44][45]}

22.3.3 Phosphorescent materials

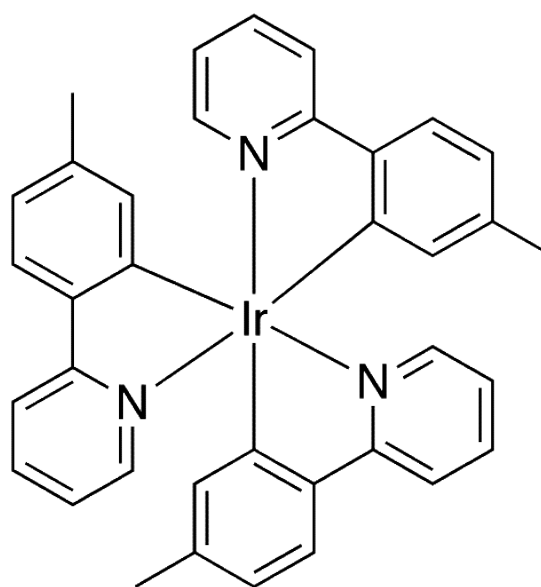

Ir(mppy)₃, a phosphorescent dopant which emits green light.^[46]

Main article: Phosphorescent organic light-emitting diode

Phosphorescent organic light emitting diodes use the principle of electrophosphorescence to convert electrical energy in an OLED into light in a highly efficient manner,^{[47][48]} with the internal quantum efficiencies of such devices approaching 100%.^[49]

Typically, a polymer such as poly(*N*-vinylcarbazole) is used as a host material to which an organometallic complex is added as a dopant. Iridium complexes^[48] such as Ir(mppy)₃^[46] are currently the focus of research, although complexes based on other heavy metals such as platinum^[47] have also been used.

The heavy metal atom at the centre of these complexes exhibits strong spin-orbit coupling, facilitating intersystem crossing between singlet and triplet states. By using these phosphorescent materials, both singlet and

triplet excitons will be able to decay radiatively, hence improving the internal quantum efficiency of the device compared to a standard PLED where only the singlet states will contribute to emission of light.

Applications of OLEDs in solid state lighting require the achievement of high brightness with good CIE coordinates (for white emission). The use of macromolecular species like polyhedral oligomeric silsesquioxanes (POSS) in conjunction with the use of phosphorescent species such as Ir for printed OLEDs have exhibited brightnesses as high as $10,000 \text{ cd/m}^2$.^[50]

22.4 Device architectures

22.4.1 Structure

Bottom or top emission Bottom or top distinction refers not to orientation of the OLED display, but to the direction that emitted light exits the device. OLED devices are classified as bottom emission devices if light emitted passes through the transparent or semi-transparent bottom electrode and substrate on which the panel was manufactured. Top emission devices are classified based on whether or not the light emitted from the OLED device exits through the lid that is added following fabrication of the device. Top-emitting OLEDs are better suited for active-matrix applications as they can be more easily integrated with a non-transparent transistor backplane. The TFT array attached to the bottom substrate on which AMOLEDs are manufactured are typically non-transparent, resulting in considerable blockage of transmitted light if the device followed a bottom emitting scheme.^[51]

Transparent OLEDs Transparent OLEDs use transparent or semi-transparent contacts on both sides of the device to create displays that can be made to be both top and bottom emitting (transparent). TOLEDs can greatly improve contrast, making it much easier to view displays in bright sunlight.^[52] This technology can be used in Head-up displays, smart windows or augmented reality applications.

Graded Heterojunction Graded heterojunction OLEDs gradually decrease the ratio of electron holes to electron transporting chemicals.^[24] This results in almost double the quantum efficiency of existing OLEDs.

Stacked OLEDs Stacked OLEDs use a pixel architecture that stacks the red, green, and blue subpixels on top of one another instead of next to one another, leading to substantial increase in gamut and color depth, and greatly reducing pixel gap. Currently, other display technologies have the RGB (and RGBW) pixels mapped next to each other decreasing potential resolution.

Inverted OLED In contrast to a conventional OLED, in which the anode is placed on the substrate, an Inverted OLED uses a bottom cathode that can be connected to the drain end of an n-channel TFT especially for the low cost amorphous silicon TFT backplane useful in the manufacturing of AMOLED displays.^[53]

22.4.2 Patterning technologies

Patternable organic light-emitting devices use a light or heat activated electroactive layer. A latent material (PEDOT-TMA) is included in this layer that, upon activation, becomes highly efficient as a hole injection layer. Using this process, light-emitting devices with arbitrary patterns can be prepared.^[54]

Colour patterning can be accomplished by means of laser, such as radiation-induced sublimation transfer (RIST).^[55]

Organic vapour jet printing (OVJP) uses an inert carrier gas, such as argon or nitrogen, to transport evaporated organic molecules (as in organic vapour phase deposition). The gas is expelled through a micrometre-sized nozzle or nozzle array close to the substrate as it is being translated. This allows printing arbitrary multilayer patterns without the use of solvents.

Conventional OLED displays are formed by vapor thermal evaporation (VTE) and are patterned by shadow-mask. A mechanical mask has openings allowing the vapor to pass only on the desired location.

Like ink jet material deposition, inkjet etching (IJE) deposits precise amounts of solvent onto a substrate designed to selectively dissolve the substrate material and induce a structure or pattern. Inkjet etching of polymer layers in OLED's can be used to increase the overall out-coupling efficiency. In OLEDs, light produced from the emissive layers of the OLED is partially transmitted out of the device and partially trapped inside the device by total internal reflection (TIR). This trapped light is wave-guided along the interior of the device until it reaches an edge where it is dissipated by either absorption and/or emission. Inkjet etching can be used to selectively alter the polymeric layers of OLED structures to decrease overall TIR and increase out-coupling efficiency of the OLED. Compared to a non-etched polymer layer, the structured polymer layer in the OLED structure from the IJE process helps to decrease the TIR of the OLED device. IJE solvents are commonly organic instead of water based due to their non-acidic nature and ability to effectively dissolve materials at temperatures under the boiling point of water.^[56]

22.4.3 Backplane technologies

For a high resolution display like a TV, a TFT backplane is necessary to drive the pixels correctly. Currently,

low temperature polycrystalline silicon (LTPS) – thin-film transistor (TFT) is used for commercial AMOLED displays. LTPS-TFT has variation of the performance in a display, so various compensation circuits have been reported.^[57] Due to the size limitation of the excimer laser used for LTPS, the AMOLED size was limited. To cope with the hurdle related to the panel size, amorphous-silicon/microcrystalline-silicon backplanes have been reported with large display prototype demonstrations.^[58]

22.4.4 Fabrication

Transfer-printing is an emerging technology with the capability to assemble large numbers of parallel OLED and AMOLED devices under efficient conditions. Transfer-printing takes advantage of standard metal deposition, photolithography, and etching to create alignment marks on device substrates, commonly glass. Thin polymer adhesive layers are applied to enhance resistance to particles and surface defects. Microscale ICs are transfer-printed onto the adhesive surface and then baked to fully cure adhesive layers. An additional photosensitive polymer layer is then applied to the substrate to account for the topography caused by the printed ICs, reintroducing a flat surface. Photolithography and etching are performed to remove some polymer layers to uncover conductive pads on the ICs. Following this step, the anode layer is applied to the device backplane to form bottom electrode. OLED layers are then applied to the anode layer using conventional vapor deposition processes, and covered with a conductive metal electrode layer. Transfer-printing is currently capable of printing onto target substrates up to 500mm X 400mm. Expansion on this size limit is needed in order for transfer-printing to become a common process for the fabrication of large OLED/AMOLED displays.^[59]

22.5 Advantages

Further information: Comparison of CRT, LCD, Plasma, and OLED

The different manufacturing process of OLEDs lends it-



Demonstration of a 4.1" prototype flexible display from Sony

self to several advantages over flat panel displays made with LCD technology.

Lower cost in the future OLEDs can be printed onto any suitable substrate by an inkjet printer or even

by screen printing,^[60] theoretically making them cheaper to produce than LCD or plasma displays. However, fabrication of the OLED substrate is more costly than that of a TFT LCD, until mass production methods lower cost through scalability. Roll-to-roll vapour-deposition methods for organic devices do allow mass production of thousands of devices per minute for minimal cost, although this technique also induces problems in that devices with multiple layers can be challenging to make because of registration, lining up the different printed layers to the required degree of accuracy.

Lightweight and flexible plastic substrates

OLED displays can be fabricated on flexible plastic substrates leading to the possible fabrication of flexible organic light-emitting diodes for other new applications, such as roll-up displays embedded in fabrics or clothing. As the substrate used can be flexible such as polyethylene terephthalate (PET),^[61] the displays may be produced inexpensively. Further, plastic substrates are shatter resistant, unlike glass displays used in LCD devices.

Wider viewing angles and improved brightness

OLEDs can enable a greater artificial contrast ratio (both dynamic range and static, measured in purely dark conditions) and a wider viewing angle compared to LCDs because OLED pixels emit light directly. OLED pixel colors appear correct and unshifted, even as the viewing angle approaches 90° from normal.

Better power efficiency and thickness LCDs filter the light emitted from a backlight, allowing a small fraction of light through. So, they cannot show true black. However, an inactive OLED element does not produce light or consume power, thus allowing true blacks.^[62] Dismissing the backlight also makes OLEDs lighter because some substrates are not needed. This allows electronics potentially to be manufactured more cheaply, but, first, a larger production scale is needed, because OLEDs still somewhat are niche products.^[63] When looking at top-emitting OLEDs, thickness also plays a role when talking about index match layers (IMLs). Emission intensity is enhanced when the IML thickness is 1.3–2.5 nm. The refractive value and the matching of the optical IMLs property, including the device structure parameters, also enhance the emission intensity at these thicknesses.^[64]

Response time OLEDs also have a much faster response time than an LCD. Using response time compensation technologies, the fastest modern LCDs can reach as low as 1ms response times for their fastest color transition and are capable of refresh frequencies as high as 144 Hz. OLED response times are up to 1,000 times faster than LCD according to LG,^[65] putting conservative estimates at under 10µs

(0.01ms), which in theory could accommodate refresh frequencies approaching 100 kHz (100,000 Hz). Due to their extremely fast response time, OLED displays can also be easily designed to interpolate black frames, creating an effect similar to CRT flicker in order to avoid the **sample-and-hold** behavior used on both LCDs and some OLED displays that creates the perception of motion blur.^[66]

22.6 Disadvantages



LEP (light emitting polymer) display showing partial failure

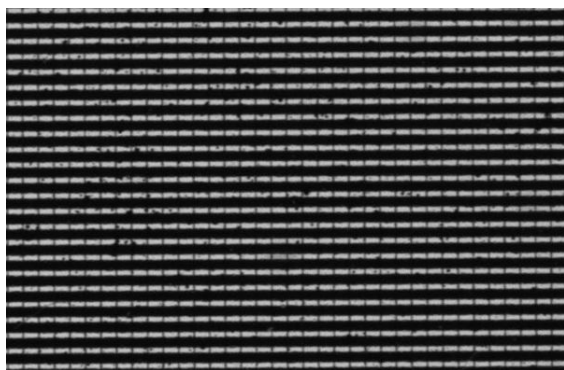

An old OLED display showing wear

Lifespan The biggest technical problem for OLEDs was the limited lifetime of the organic materials. One 2008 technical report on an OLED TV panel found that “After 1,000 hours the blue luminance degraded by 12%, the red by 7% and the green by 8%.”^[67] In particular, blue OLEDs historically have had a lifetime of around 14,000 hours to half original brightness (five years at 8 hours a day) when used for flat-panel displays. This is lower than the typical lifetime of LCD, LED or PDP technology. Each currently is rated for about 25,000–40,000

hours to half brightness, depending on manufacturer and model.^{[68][69]} Degradation occurs because of the accumulation of nonradiative recombination centers and luminescence quenchers in the emissive zone. It is said that the chemical breakdown in the semiconductors occurs in four steps: 1) recombination of charge carriers through the absorption of UV light, 2) homolytic dissociation, 3) subsequent radical addition reactions that form π radicals, and 4) disproportionation between two radicals resulting in hydrogen-atom transfer reactions.^[70] However, some manufacturers’ displays aim to increase the lifespan of OLED displays, pushing their expected life past that of LCD displays by improving light outcoupling, thus achieving the same brightness at a lower drive current.^{[71][72]} In 2007, experimental OLEDs were created which can sustain 400 cd/m² of luminance for over 198,000 hours for green OLEDs and 62,000 hours for blue OLEDs.^[73]

Color balance Additionally, as the OLED material used to produce blue light degrades significantly more rapidly than the materials that produce other colors, blue light output will decrease relative to the other colors of light. This variation in the differential color output will change the color balance of the display and is much more noticeable than a decrease in overall luminance.^[74] This can be avoided partially by adjusting color balance, but this may require advanced control circuits and interaction with the user, which is unacceptable for some users. More commonly, though, manufacturers optimize the size of the R, G and B subpixels to reduce the current density through the subpixel in order to equalize lifetime at full luminance. For example, a blue subpixel may be 100% larger than the green subpixel. The red subpixel may be 10% smaller than the green.

Efficiency of blue OLEDs Improvements to the efficiency and lifetime of blue OLEDs is vital to the success of OLEDs as replacements for LCD technology. Considerable research has been invested in developing blue OLEDs with high external quantum efficiency as well as a deeper blue color.^{[75][76]} External quantum efficiency values of 20% and 19% have been reported for red (625 nm) and green (530 nm) diodes, respectively.^{[77][78]} However, blue diodes (430 nm) have only been able to achieve maximum external quantum efficiencies in the range of 4% to 6%.^[79]

Water damage Water can instantly damage the organic materials of the displays. Therefore, improved sealing processes are important for practical manufacturing. Water damage especially may limit the longevity of more flexible displays.^[80]

Outdoor performance As an emissive display technology, OLEDs rely completely upon converting electricity to light, unlike most LCDs which are to some

extent reflective. e-paper leads the way in efficiency with ~ 33% ambient light reflectivity, enabling the display to be used without any internal light source. The metallic cathode in an OLED acts as a mirror, with reflectance approaching 80%, leading to poor readability in bright ambient light such as outdoors. However, with the proper application of a circular polarizer and antireflective coatings, the diffuse reflectance can be reduced to less than 0.1%. With 10,000 fc incident illumination (typical test condition for simulating outdoor illumination), that yields an approximate photopic contrast of 5:1. Recent advances in OLED technologies, however, enable OLEDs to become actually better than LCDs in bright sunlight. The Super AMOLED display in the Galaxy S5, for example, was found to outperform all LCD displays on the market in terms of brightness and reflectance.^[81]

Power consumption While an OLED will consume around 40% of the power of an LCD displaying an image that is primarily black, for the majority of images it will consume 60–80% of the power of an LCD. However, an OLED can use more than three times as much power to display an image with a white background, such as a document or web site.^[82] This can lead to reduced battery life in mobile devices, when white backgrounds are used.

22.7 Manufacturers and commercial uses

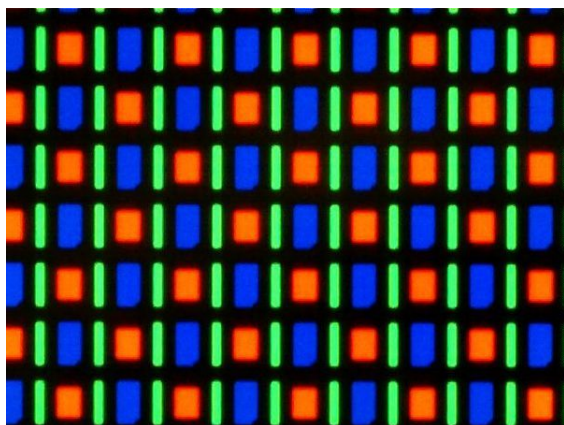

Magnified image of the AMOLED screen on the Google Nexus One smartphone using the RGBG system of the PenTile Matrix Family.

OLED technology is used in commercial applications such as displays for mobile phones and portable digital media players, car radios and digital cameras among others. Such portable applications favor the high light output of OLEDs for readability in sunlight and their low power drain. Portable displays are also used intermit-



A 3.8 cm (1.5 in) OLED display from a Creative ZEN V media player

tently, so the lower lifespan of organic displays is less of an issue. Prototypes have been made of flexible and rollable displays which use OLEDs' unique characteristics. Applications in flexible signs and lighting are also being developed.^[83] Philips Lighting have made OLED lighting samples under the brand name "Lumiblade" available online^[84] and Novald AG based in Dresden, Germany, introduced a line of OLED desk lamps called "Victory" in September, 2011.^[85]

Universal Display Corporation (UDC) is a leader in researching, developing and delivering OLED technologies. Founded in 1994, the company currently owns or has exclusive, co-exclusive or sole license rights with respect to more than 3,000 issued and pending patents worldwide for the commercialization of phosphorescent based OLEDs and also flexible, transparent and stacked OLEDs – for both display and lighting applications. Universal Display works and partners with a network of organizations, including Princeton University, the University of Southern California, the University of Michigan, and PPG Industries, Inc. Its phosphorescent OLED technologies and materials are licensed and supplied to companies such as Samsung, LG, AU Optronics CMEL, Pioneer, Panasonic Idemitsu OLED lighting and Konica Minolta. UDC is working with many other companies, including Sony, DuPont and Novald. Back in 2009 UDC claimed that "virtually all AMOLEDs on the market use our technology".^[86]

OLEDs have been used in most Motorola and Samsung color cell phones, as well as some HTC, LG and Sony Ericsson models.^[87] Nokia has also introduced some OLED products including the N85 and the N86 8MP, both of which feature an AMOLED display. OLED technology can also be found in digital media players such as the Creative ZEN V, the iriver clix, the Zune HD and the Sony Walkman X Series.

The Google and HTC Nexus One smartphone includes an AMOLED screen, as does HTC's own Desire and Legend phones. However due to supply shortages of the

Samsung-produced displays, certain HTC models will use Sony's *SLCD* displays in the future,^[88] while the Google and Samsung *Nexus S* smartphone will use "Super Clear LCD" instead in some countries.^[89]

OLED displays were used in watches made by Fossil (JR-9465) and Diesel (DZ-7086).

Other manufacturers of OLED panels include Anwell Technologies Limited (Hong Kong),^[90] AU Optronics (Taiwan),^[91] Chimei Innolux Corporation (Taiwan),^[92] LG (Korea),^[93] and others.^[94]

In 2009, Shearwater Research introduced the Predator as the first color OLED diving computer available with a user replaceable battery.^{[95][96]}

DuPont stated in a press release in May 2010 that they can produce a 50-inch OLED TV in two minutes with a new printing technology. If this can be scaled up in terms of manufacturing, then the total cost of OLED TVs would be greatly reduced. DuPont also states that OLED TVs made with this less expensive technology can last up to 15 years if left on for a normal eight-hour day.^{[97][98]}

The use of OLEDs may be subject to patents held by Universal Display Corporation, Eastman Kodak, DuPont, General Electric, Royal Philips Electronics, numerous universities and others.^[99] There are by now thousands of patents associated with OLEDs, both from larger corporations and smaller technology companies.

RIM, the maker of BlackBerry smartphones, use OLED displays in their BlackBerry 10 devices.

A technical writer at the Sydney Herald thinks foldable OLED smartphones could be as much as a decade away because of the cost of producing them. There is a relatively high failure rate when producing these screens. As little as a speck of dust can ruin a screen during production. Creating a battery that can be folded is another hurdle.^[100] However, Samsung have accelerated their plans to release a foldable display by the end of 2015^[101]

22.7.1 Fashion

Textiles incorporating OLEDs are an innovation in the fashion world and pose for a way to integrate lighting to bring inert objects to a whole new level of fashion. The hope is to combine the comfort and low cost properties of textile with the OLEDs properties of illumination and low energy consumption. Although this scenario of illuminated clothing is highly plausible, challenges are still a road block. Some issues include: the lifetime of the OLED, rigidity of flexible foil substrates, and the lack of research in making more fabric like photonic textiles.^[102]

22.7.2 Samsung applications

By 2004 Samsung, South Korea's largest conglomerate, was the world's largest OLED manufacturer, producing 40% of the OLED displays made in the world,^[103] and as of 2010 has a 98% share of the global AMOLED market.^[104] The company is leading the world of OLED industry, generating \$100.2 million out of the total \$475 million revenues in the global OLED market in 2006.^[105] As of 2006, it held more than 600 American patents and more than 2800 international patents, making it the largest owner of AMOLED technology patents.^[105]

Samsung SDI announced in 2005 the world's largest OLED TV at the time, at 21 inches (53 cm).^[106] This OLED featured the highest resolution at the time, of 6.22 million pixels. In addition, the company adopted active matrix based technology for its low power consumption and high-resolution qualities. This was exceeded in January 2008, when Samsung showcased the world's largest and thinnest OLED TV at the time, at 31 inches (78 cm) and 4.3 mm.^[107]

In May 2008, Samsung unveiled an ultra-thin 12.1 inch (30 cm) laptop OLED display concept, with a 1,280×768 resolution with infinite contrast ratio.^[108] According to Woo Jong Lee, Vice President of the Mobile Display Marketing Team at Samsung SDI, the company expected OLED displays to be used in notebook PCs as soon as 2010.^[109]

In October 2008, Samsung showcased the world's thinnest OLED display, also the first to be "flappable" and bendable.^[110] It measures just 0.05 mm (thinner than paper), yet a Samsung staff member said that it is "technically possible to make the panel thinner".^[110] To achieve this thickness, Samsung etched an OLED panel that uses a normal glass substrate. The drive circuit was formed by low-temperature polysilicon TFTs. Also, low-molecular organic EL materials were employed. The pixel count of the display is 480 × 272. The contrast ratio is 100,000:1, and the luminance is 200 cd/m². The colour reproduction range is 100% of the NTSC standard.

In the same month, Samsung unveiled what was then the world's largest OLED Television at 40-inch with a Full HD resolution of 1920 × 1080 pixels.^[111] In the FPD International, Samsung stated that its 40-inch OLED Panel is the largest size currently possible. The panel has a contrast ratio of 1,000,000:1, a colour gamut of 107% NTSC, and a luminance of 200 cd/m² (peak luminance of 600 cd/m²).

At the Consumer Electronics Show (CES) in January 2010, Samsung demonstrated a laptop computer with a large, transparent OLED display featuring up to 40% transparency^[112] and an animated OLED display in a photo ID card.^[113]

Samsung's latest AMOLED smartphones use their Super AMOLED trademark, with the Samsung Wave S8500 and Samsung i9000 Galaxy S being launched in June

2010. In January 2011 Samsung announced their Super AMOLED Plus displays, which offer several advances over the older Super AMOLED displays: real stripe matrix (50% more sub pixels), thinner form factor, brighter image and an 18% reduction in energy consumption.^[114]

At CES 2012, Samsung introduced the first 55" TV screen that uses Super OLED technology.<ref name="CES-2012-review">Clark, Shaylin (2012-01-12). CES 2012: Samsung's OLED TV Rakes In Awards. WebProNews. Retrieved 2012-12-03.</ref>

On January 8, 2013, at CES Samsung unveiled a unique curved 4K Ultra S9 OLED television, which they state provides an "IMAX-like experience" for viewers.<ref name="Samsung's curved OLED TV provides an 'IMAX-like' experience">Rougeau, Michael (2013-01-08). . Techradar. Retrieved 2013-01-08.</ref>

On August 13, 2013, Samsung announced availability of a 55-inch curved OLED TV (model KN55S9C) in the US at a price point of \$8999.99.^[115]

On September 6, 2013, Samsung launched its 55-inch curved OLED TV (model KE55S9C) in the United Kingdom with John Lewis.^[116]

Samsung introduced the *Galaxy Round* smartphone in the Korean market in October 2013. The device features a 1080p screen, measuring 5.7 inches (14 cm), that curves on the vertical axis in a rounded case. The corporation has promoted the following advantages: A new feature called "Round Interaction" that allows users to look at information by tilting the handset on a flat surface with the screen off, and the feel of one continuous transition when the user switches between home screens.^[117]

22.7.3 Sony applications



Sony XEL-1, the world's first OLED TV.^[118] (front)

The Sony CLIE PEG-VZ90 was released in 2004, being the first PDA to feature an OLED screen.^[119] Other Sony products to feature OLED screens include the MZ-RH1 portable minidisc recorder, released in 2006^[120] and the Walkman X Series.^[121]

At the 2007 Las Vegas Consumer Electronics Show (CES), Sony showcased 11-inch (28 cm, resolution 960×540) and 27-inch (68.5 cm), full HD resolution at 1920 × 1080 OLED TV models.^[122] Both claimed 1,000,000:1 contrast ratios and total thicknesses (including bezels) of 5 mm. In April 2007, Sony announced it would manufacture 1000 11-inch (28 cm) OLED TVs per month for market testing purposes.^[123] On October 1, 2007, Sony announced that the 11-inch (28 cm) model, now called the XEL-1, would be released commercially;^[118] the XEL-1 was first released in Japan in December 2007.^[124]

In May 2007, Sony publicly unveiled a video of a 2.5-inch flexible OLED screen which is only 0.3 millimeters thick.^[125] At the Display 2008 exhibition, Sony demonstrated a 0.2 mm thick 3.5 inch (9 cm) display with a resolution of 320×200 pixels and a 0.3 mm thick 11 inch (28 cm) display with 960×540 pixels resolution, one-tenth the thickness of the XEL-1.^{[126][127]}

In July 2008, a Japanese government body said it would fund a joint project of leading firms, which is to develop a key technology to produce large, energy-saving organic displays. The project involves one laboratory and 10 companies including Sony Corp. NEDO said the project was aimed at developing a core technology to mass-produce 40 inch or larger OLED displays in the late 2010s.^[128]

In October 2008, Sony published results of research it carried out with the Max Planck Institute over the possibility of mass-market bending displays, which could replace rigid LCDs and plasma screens. Eventually, bendable, see-through displays could be stacked to produce 3D images with much greater contrast ratios and viewing angles than existing products.^[129]

Sony exhibited a 24.5" (62 cm) prototype OLED 3D television during the Consumer Electronics Show in January 2010.^[130]

In January 2011, Sony announced the PlayStation Vita handheld game console (the successor to the PSP) will feature a 5-inch OLED screen.^[131]

On February 17, 2011, Sony announced its 25" (63.5 cm) OLED Professional Reference Monitor aimed at the Cinema and high end Drama Post Production market.^[132]

On June 25, 2012, Sony and Panasonic announced a joint venture for creating low cost mass production OLED televisions by 2013.^[133]

22.7.4 LG applications

As of 2010, LG Electronics produced one model of OLED television, the 15 inch 15EL9500^[134] and had announced a 31" (78 cm) OLED 3D television for March 2011.^[135] On December 26, 2011, LG officially announced the "world's largest 55" OLED panel" and featured it at CES 2012.^[136] In late 2012, LG an-

announces the launch of the 55EM9600 OLED television in Australia.^[137]

CNET reviewed the LG 55EC9300 OLED Television in September 2014 and called it the “Best. Picture. Ever.” offering better picture quality than LED TV and Plasma TV and without their disadvantages.^[138]

In January 2015, LG Display signed a long term agreement with Universal Display Corporation for the supply of OLED materials and the right to use their patented OLED emitters.^[139]

22.7.5 Mitsubishi applications

Lumiotec is the first company in the world developing and selling, since January 2011, mass-produced OLED lighting panels with such brightness and long lifetime. Lumiotec is a joint venture of Mitsubishi Heavy Industries, ROHM, Toppan Printing, and Mitsui & Co. On June 1, 2011, Mitsubishi installed a 6-meter OLED 'sphere' in Tokyo's Science Museum.^[140]

22.7.6 Recom Group/video name tag applications

On January 6, 2011, Los Angeles based technology company Recom Group introduced the first small screen consumer application of the OLED at the Consumer Electronics Show in Las Vegas. This was a 2.8” (7 cm) OLED display being used as a wearable video name tag.^[141] At the Consumer Electronics Show in 2012, Recom Group introduced the world's first video mic flag incorporating three 2.8” (7 cm) OLED displays on a standard broadcasters mic flag. The video mic flag allowed video content and advertising to be shown on a broadcasters standard mic flag.^[142]

22.7.7 BMW

BMW plans to use OLEDs in tail lights and interior lights in their future cars; however, OLEDs are currently too dim to be used for brake lights, headlights and indicators.^[143]

22.8 Research

In 2014, Mitsubishi Chemical Corporation (MCC), a subsidiary of the Mitsubishi Chemical Holdings developed an organic light-emitting diode (OLED) panel with a life of 30,000 hours, twice that of conventional OLED panels.^[144]

The search for efficient OLED materials has been extensively supported by simulation methods. By now it is possible to calculate important properties completely com-

putationally, independent of experimental input.^{[145][146]} This allows cost-efficient pre-screening of materials, prior to expensive synthesis and experimental characterisation.

22.9 See also

- Comparison of display technology
- Field emission display
- Flexible electronics
- List of emerging technologies
- Molecular electronics
- Organic Light Emitting Transistor
- Printed electronics
- Rollable display
- Quantum dot display
- Roll-to-roll
- Surface-conduction electron-emitter display

22.10 References

- [1] Kamtekar, K. T.; Monkman, A. P.; Bryce, M. R. (2010). “Recent Advances in White Organic Light-Emitting Materials and Devices (WOLEDs)”. *Advanced Materials* **22** (5): 572. doi:10.1002/adma.200902148.
- [2] D'Andrade, B. W.; Forrest, S. R. (2004). “White Organic Light-Emitting Devices for Solid-State Lighting”. *Advanced Materials* **16** (18): 1585. doi:10.1002/adma.200400684.
- [3] Chang, Yi-Lu; Lu, Zheng-Hong (2013). “White Organic Light-Emitting Diodes for Solid-State Lighting”. *Journal of Display Technology* **PP** (99): 1. Bibcode:2013JDisT...9..459C. doi:10.1109/JDT.2013.2248698.
- [4] Bernanose, A.; Comte, M.; Vouaux, P. (1953). “A new method of light emission by certain organic compounds”. *J. Chim. Phys.* **50**: 64.
- [5] Bernanose, A.; Vouaux, P. (1953). “Organic electroluminescence type of emission”. *J. Chim. Phys.* **50**: 261.
- [6] Bernanose, A. (1955). “The mechanism of organic electroluminescence”. *J. Chim. Phys.* **52**: 396.
- [7] Bernanose, A. and Vouaux, P. (1955). *J. Chim. Phys.* **52**: 509. Missing or empty |title= (help)
- [8] Kallmann, H.; Pope, M. (1960). “Positive Hole Injection into Organic Crystals”. *The Journal of Chemical Physics* **32**: 300. Bibcode:1960JChPh..32..300K. doi:10.1063/1.1700925.

- [9] Kallmann, H.; Pope, M. (1960). "Bulk Conductivity in Organic Crystals". *Nature* **186** (4718): 31. Bibcode:1960Natur.186...31K. doi:10.1038/186031a0.
- [10] Mark, Peter; Helfrich, Wolfgang (1962). "Space-Charge-Limited Currents in Organic Crystals". *Journal of Applied Physics* **33**: 205. Bibcode:1962JAP...33..205M. doi:10.1063/1.1728487.
- [11] Pope, M.; Kallmann, H. P.; Magnante, P. (1963). "Electroluminescence in Organic Crystals". *The Journal of Chemical Physics* **38** (8): 2042. Bibcode:1963JChPh..38.2042P. doi:10.1063/1.1733929.
- [12] Sano, Mizuka; Pope, Martin; Kallmann, Hartmut (1965). "Electroluminescence and Band Gap in Anthracene". *The Journal of Chemical Physics* **43** (8): 2920. Bibcode:1965JChPh..43.2920S. doi:10.1063/1.1697243.
- [13] Helfrich, W.; Schneider, W. (1965). "Recombination Radiation in Anthracene Crystals". *Physical Review Letters* **14** (7): 229. Bibcode:1965PhRvL..14..229H. doi:10.1103/PhysRevLett.14.229.
- [14] Gurnee, E. and Fernandez, R. "Organic electroluminescent phosphors", U.S. Patent 3,172,862, Issue date: March 9, 1965
- [15] Partridge, Roger Hugh, "Radiation sources" U.S. Patent 3,995,299, Issue date: November 30, 1976
- [16] Partridge, R (1983). "Electroluminescence from polyvinylcarbazole films: 1. Carbazole cations". *Polymer* **24** (6): 733. doi:10.1016/0032-3861(83)90012-5.
- [17] Partridge, R (1983). "Electroluminescence from polyvinylcarbazole films: 2. Polyvinylcarbazole films containing antimony pentachloride". *Polymer* **24** (6): 739. doi:10.1016/0032-3861(83)90013-7.
- [18] Partridge, R (1983). "Electroluminescence from polyvinylcarbazole films: 3. Electroluminescent devices". *Polymer* **24** (6): 748. doi:10.1016/0032-3861(83)90014-9.
- [19] Partridge, R (1983). "Electroluminescence from polyvinylcarbazole films: 4. Electroluminescence using higher work function cathodes". *Polymer* **24** (6): 755. doi:10.1016/0032-3861(83)90015-0.
- [20] Tang, C. W.; Vanslyke, S. A. (1987). "Organic electroluminescent diodes". *Applied Physics Letters* **51** (12): 913. Bibcode:1987ApPhL...51..913T. doi:10.1063/1.98799.
- [21] Burroughes, J. H.; Bradley, D. D. C.; Brown, A. R.; Marks, R. N.; MacKay, K.; Friend, R. H.; Burns, P. L.; Holmes, A. B. (1990). "Light-emitting diodes based on conjugated polymers". *Nature* **347** (6293): 539. Bibcode:1990Natur.347..539B. doi:10.1038/347539a0.
- [22] Piromreun, Pongpun; Oh, Hwansool; Shen, Yulong; Malliaras, George G.; Scott, J. Campbell; Brock, Phil J. (2000). "Role of CsF on electron injection into a conjugated polymer". *Applied Physics Letters* **77** (15): 2403. Bibcode:2000ApPhL..77.2403P. doi:10.1063/1.1317547.
- [23] D. Ammermann, A. Böhler, W. Kowalsky, *Multilayer Organic Light Emitting Diodes for Flat Panel Displays*, Institut für Hochfrequenztechnik, TU Braunschweig, 1995.
- [24] "Organic Light-Emitting Diodes Based on Graded Heterojunction Architecture Has Greater Quantum Efficiency". University of Minnesota. Retrieved 31 May 2011.
- [25] Holmes, Russell; Erickson, N.; Lüssem, Björn; Leo, Karl (27 August 2010). "Highly efficient, single-layer organic light-emitting devices based on a graded-composition emissive layer". *Applied Physics Letters* **97**: 083308. Bibcode:2010ApPhL..97a3308S. doi:10.1063/1.3460285.
- [26] Lin Ke, Peng; Ramadas, K.; Burden, A.; Soo-Jin, C. (June 2006). "Indium-Tin-Oxide-Free Organic Light-Emitting Devices". *Transactions on Electron Devices* **53** (6): 1483. JSTOR 0018-9383.
- [27] Carter, S. A.; Angelopoulos, M.; Karg, S.; Brock, P. J.; Scott, J. C. (1997). "Polymeric anodes for improved polymer light-emitting diode performance". *Applied Physics Letters* **70** (16): 2067. Bibcode:1997ApPhL..70.2067C. doi:10.1063/1.118953.
- [28] Friend, R. H.; Gymer, R. W.; Holmes, A. B.; Burroughes, J. H.; Marks, R. N.; Taliani, C.; Bradley, D. D. C.; Santos, D. A. Dos; Brdas, J. L.; Lgdlund, M.; Salaneck, W. R. (1999). "Electroluminescence in conjugated polymers". *Nature* **397** (6715): 121. Bibcode:1999Natur.397..121F. doi:10.1038/16393.
- [29] "Spintronic OLEDs could be brighter and more efficient". *Engineer (Online Edition)*: 1. 16 July 2012.
- [30] Davids, P. S.; Kogan, Sh. M.; Parker, I. D.; Smith, D. L. (1996). "Charge injection in organic light-emitting diodes: Tunneling into low mobility materials". *Applied Physics Letters* **69** (15): 2270. Bibcode:1996ApPhL..69.2270D. doi:10.1063/1.117530.
- [31] Crone, B. K.; Campbell, I. H.; Davids, P. S.; Smith, D. L. (1998). "Charge injection and transport in single-layer organic light-emitting diodes". *Applied Physics Letters* **73** (21): 3162. Bibcode:1998ApPhL..73.3162C. doi:10.1063/1.122706.
- [32] Crone, B. K.; Campbell, I. H.; Davids, P. S.; Smith, D. L.; Neef, C. J.; Ferraris, J. P. (1999). "Device physics of single layer organic light-emitting diodes". *Journal of Applied Physics* **86** (10): 5767. Bibcode:1999JAP...86.5767C. doi:10.1063/1.371591.
- [33] Bellmann, E.; Shaheen, S. E.; Thayumanavan, S.; Barlow, S.; Grubbs, R. H.; Marder, S. R.; Kippelen, B.; Peyghambarian, N. (1998). "New Triarylamine-Containing Polymers as Hole Transport Materials in Organic Light-Emitting Diodes: Effect of Polymer Structure and Cross-Linking on Device Characteristics". *Chemistry of Materials* **10** (6): 1668. doi:10.1021/cm980030p.
- [34] Sato, Y.; Ichinosawa, S.; Kanai, H. (1998). "Operation Characteristics and Degradation of Organic Electroluminescent Devices". *IEEE Journal of Selected Topics in Quantum Electronics* **4**: 40. doi:10.1109/2944.669464.

- [35] Duarte, FJ; Liao, LS; Vaeth, KM (2005). "Coherence characteristics of electrically excited tandem organic light-emitting diodes". *Optics letters* **30** (22): 3072–4. Bibcode:2005OptL...30.3072D. doi:10.1364/OL.30.003072. PMID 16315725.
- [36] Duarte, FJ (2007). "Coherent electrically excited organic semiconductors: visibility of interferograms and emission linewidth". *Optics letters* **32** (4): 412–4. Bibcode:2007OptL...32..412D. doi:10.1364/OL.32.000412. PMID 17356670.
- [37] Synopsis: A Single-Molecule Light-Emitting Diode, Physics, 28 January 2014
- [38] Researchers Develop First Single-Molecule LED, Photonics Online, 31 January 2014
- [39] Hebner, T. R.; Wu, C. C.; Marcy, D.; Lu, M. H.; Sturm, J. C. (1998). "Ink-jet printing of doped polymers for organic light emitting devices". *Applied Physics Letters* **72** (5): 519. Bibcode:1998ApPhL...72..519H. doi:10.1063/1.120807.
- [40] Bharathan, Jayesh; Yang, Yang (1998). "Polymer electroluminescent devices processed by inkjet printing: I. Polymer light-emitting logo". *Applied Physics Letters* **72** (21): 2660. Bibcode:1998ApPhL...72.2660B. doi:10.1063/1.121090.
- [41] A. J. Heeger, in W. R. Salaneck, I. Lundstrom, B. Ranby, *Conjugated Polymers and Related Materials*, Oxford 1993, 27–62. ISBN 0-19-855729-9
- [42] R. Kiebooms, R. Menon, K. Lee, in H. S. Nalwa, *Handbook of Advanced Electronic and Photonic Materials and Devices Volume 8*, Academic Press 2001, 1–86.
- [43] Wagaman, Michael; Grubbs, Robert H. (1997). "Synthesis of PNV Homo- and Copolymers by a ROMP Precursor Route". *Synthetic Metals* **84** (1–3): 327–328. doi:10.1016/S0379-6779(97)80767-9.
- [44] Wagaman, Michael; Grubbs, Robert H. (1997). "Synthesis of Organic and Water Soluble Poly(1,4-phenylenevinylenes) Containing Carboxyl Groups: Living Ring-Opening Metathesis Polymerization (ROMP) of 2,3-Dicarboxybarrelenes". *Macromolecules* **30** (14): 3978–3985. Bibcode:1997MaMol...30.3978W. doi:10.1021/ma9701595.
- [45] Pu, Lin; Wagaman, Michael; Grubbs, Robert H. (1996). "Synthesis of Poly(1,4-naphthylenevinylenes): Metathesis Polymerization of Benzobarrelenes". *Macromolecules* **29** (4): 1138–1143. Bibcode:1996MaMol...29.1138P. doi:10.1021/ma9500143.
- [46] Yang, Xiaohui; Neher, Dieter; Hertel, Dirk; Daubler, Thomas (2004). "Highly Efficient Single-Layer Polymer Electrophosphorescent Devices". *Advanced Materials* **16** (2): 161. doi:10.1002/adma.200305621.
- [47] Baldo, M. A.; O'Brien, D. F.; You, Y.; Shoustikov, A.; Sibley, S.; Thompson, M. E.; Forrest, S.R. (1998). "Highly Efficient phosphorescent emission from organic electroluminescent devices". *Nature* **395** (6698): 151. Bibcode:1998Natur...395..151B. doi:10.1038/25954.
- [48] Baldo, M. A.; Lamansky, S.; Burrows, P. E.; Thompson, M. E.; Forrest, S. R. (1999). "Very high-efficiency green organic light-emitting devices based on electrophosphorescence". *Applied Physics Letters* **75**: 4. Bibcode:1999ApPhL...75....4B. doi:10.1063/1.124258.
- [49] Adachi, C.; Baldo, M. A.; Thompson, M. E.; Forrest, S. R. (2001). "Nearly 100% internal phosphorescence efficiency in an organic light-emitting device". *Journal of Applied Physics* **90** (10): 5048. Bibcode:2001JAP...90.5048A. doi:10.1063/1.1409582.
- [50] Singh, Madhusudan; Chae, Hyun Sik; Froehlich, Jesse D.; Kondou, Takashi; Li, Sheng; Mochizuki, Amane; Jabbour, Ghassan E. (2009). "Electroluminescence from printed stellate polyhedral oligomeric silsesquioxanes". *Soft Matter* **5** (16): 3002. Bibcode:2009SMat....5.3002S. doi:10.1039/b903531a.
- [51] Bardsley, J. N. (2004). "International OLED Technology Roadmap". *IEEE Journal of Selected Topics in Quantum Electronics* **10**: 3–4. doi:10.1109/JSTQE.2004.824077.
- [52] US 5986401, Mark E. Thompson, Stephen R. Forrest, Paul Burrows, "High contrast transparent organic light emitting device display", published 1999-11-16
- [53] Chu, Ta-Ya; Chen, Jenn-Fang; Chen, Szu-Yi; Chen, Chao-Jung; Chen, Chin H. (2006). "Highly efficient and stable inverted bottom-emission organic light emitting devices". *Applied Physics Letters* **89** (5): 053503. Bibcode:2006ApPhL...89e3503C. doi:10.1063/1.2268923.
- [54] Liu, Jie; Lewis, Larry N.; Duggal, Anil R. (2007). "Photoactivated and patternable charge transport materials and their use in organic light-emitting devices". *Applied Physics Letters* **90** (23): 233503. Bibcode:2007ApPhL...90w3503L. doi:10.1063/1.2746404.
- [55] Boroson, Michael; Tutt, Lee; Nguyen, Kelvin; Preuss, Don; Culver, Myron; Phelan, Giana (2005). "16.5L: Late-News-Paper: Non-Contact OLED Color Patterning by Radiation-Induced Sublimation Transfer (RIST)". *SID Symposium Digest of Technical Papers* **36**: 972. doi:10.1889/1.2036612.
- [56] Grimaldi, I. A.; De Girolamo Del Mauro, A.; Nenna, G.; Loffredo, F.; Minarini, C.; Villani, F.; d'Amore, A.; Acierno, D.; Grassia, L. (2010). "Inkjet Etching of Polymer Surfaces to Manufacture Microstructures for OLED Applications". *AIP Conference Proceedings*. p. 104. doi:10.1063/1.3455544.
- [57] Sasaoka, Tatsuya; Sekiya, Mitsunobu; Yumoto, Akira; Yamada, Jiro; Hirano, Takashi; Iwase, Yuichi; Yamada, Takao; Ishibashi, Tadashi; Mori, Takao; Asano, Mitsuru; Tamura, Shinichiro; Urabe, Tetsuo (2001). "24.4L: Late-News Paper: A 13.0-inch AM-OLED Display with Top Emitting Structure and Adaptive Current Mode Programmed Pixel Circuit (TAC)". *SID Symposium Digest of Technical Papers* **32**: 384. doi:10.1889/1.1831876.
- [58] Tsujimura, T.; Kobayashi, Y.; Murayama, K.; Tanaka, A.; Morooka, M.; Fukumoto, E.; Fujimoto, H.; Sekine, J.;

- Kanoh, K.; Takeda, K.; Miwa, K.; Asano, M.; Ikeda, N.; Kohara, S.; Ono, S.; Chung, C. T.; Chen, R. M.; Chung, J. W.; Huang, C. W.; Guo, H. R.; Yang, C. C.; Hsu, C. C.; Huang, H. J.; Riess, W.; Riel, H.; Karg, S.; Beierlein, T.; Gundlach, D.; Alvarado, S. et al. (2003). "4.1: A 20-inch OLED Display Driven by Super-Amorphous-Silicon Technology". *SID Symposium Digest of Technical Papers* **34**: 6. doi:10.1889/1.1832193.
- [59] Bower, C. A.; Menard, E.; Bonafede, S.; Hamer, J. W.; Cok, R. S. (2011). "Transfer-Printed Microscale Integrated Circuits for High Performance Display Backplanes". *IEEE Transactions on Components, Packaging and Manufacturing Technology* **1** (12): 1916. doi:10.1109/TCPMT.2011.2128324.
- [60] Pardo, Dino A.; Jabbour, G. E.; Peyghambarian, N. (2000). "Application of Screen Printing in the Fabrication of Organic Light-Emitting Devices". *Advanced Materials* **12** (17): 1249. doi:10.1002/1521-4095(200009)12:17<1249::AID-ADMA1249>3.0.CO;2-Y.
- [61] Gustafsson, G.; Cao, Y.; Treacy, G. M.; Klavetter, F.; Colaneri, N.; Heeger, A. J. (1992). "Flexible light-emitting diodes made from soluble conducting polymers". *Nature* **357** (6378): 477. Bibcode:1992Natur.357..477G. doi:10.1038/357477a0.
- [62] "Comparison of OLED and LCD". Fraunhofer IAP: OLED Research. 2008-11-18. Retrieved 2010-01-25.
- [63] Wong, William (16 December 2004). "Firefox: A Browser For Embedded Applications". *Electronic Design* **52** (28): 25.
- [64] Zhang, Mingxiao; Chen, Z.; Xiao, L.; Qu, B.; Gong, Q. (18 March 2013). "Optical design for improving optical properties of top-emitting organic light emitting diodes". *Journal of Applied Physics* **113** (11): 113105. Bibcode:2013JAP...113k3105Z. doi:10.1063/1.4795584.
- [65] "LG 55EM9700". 2013-01-02. Retrieved 2015-01-14.
- [66] "Why Do Some OLEDs Have Motion Blur?". Blur Busters Blog (based on Microsoft Research work). 2013-04-15. Retrieved 2013-04-18.
- [67] "OLED TV estimated lifespan shorter than expected". HDTV Info Europe. Hdtvinfo.eu (2008-05-08).
- [68] HP Monitor manual. CCFL-Backlit LCD. Page 32. Webcitation.org. Retrieved 2011-10-04.
- [69] Viewsonic Monitor manual. LED-Backlit LCD. Webcitation.org. Retrieved 2011-10-04.
- [70] Kondakov, D; Lenhart, W.; Nichols, W. (2007). "Operational degradation of organic light-emitting diodes: Mechanism and identification of chemical products". *Journal of Applied Physics* **101** (2): 1. Bibcode:2007JAP...101b4512K. doi:10.1063/1.2430922.
- [71] "OLED lifespan doubled?" HDTV Info Europe. Hdtvinfo.eu (2008-01-25).
- [72] Toshiba and Panasonic double lifespan of OLED, January 25, 2008, Toshiba and Panasonic double lifespan of OLED
- [73] Cambridge Display Technology, Cambridge Display Technology and Sumation Announce Strong Lifetime Improvements to P-OLED (Polymer OLED) Material; Blue P-OLED Materials Hit 10,000 Hour Lifetime Milestone at 1,000 cd/sq.m, March 26, 2007. Retrieved January 11, 2011.
- [74] "Ageless OLED". Retrieved 2009-11-16.
- [75] Shen, Jiun Yi; Lee, Chung Ying; Huang, Tai-Hsiang; Lin, Jiann T.; Tao, Yu-Tai; Chien, Chin-Hsiung; Tsai, Chitang (2005). "High Tg blue emitting materials for electroluminescent devices". *Journal of Materials Chemistry (FREE TEXT)* **15** (25): 2455. doi:10.1039/b501819f.
- [76] Kim, Seul Ong; Lee, Kum Hee; Kim, Gu Young; Seo, Ji Hoon; Kim, Young Kwan; Yoon, Seung Soo (2010). "A highly efficient deep blue fluorescent OLED based on diphenylaminofluorenylstyrene-containing emitting materials". *Synthetic Metals* **160** (11–12): 1259. doi:10.1016/j.synthmet.2010.03.020.
- [77] Jabbour, G. E.; Kawabe, Y.; Shaheen, S. E.; Wang, J. F.; Morrell, M. M.; Kippelen, B.; Peyghambarian, N. (1997). "Highly efficient and bright organic electroluminescent devices with an aluminum cathode". *Applied Physics Letters* **71** (13): 1762. Bibcode:1997ApPhL..71.1762J. doi:10.1063/1.119392.
- [78] Mikami, Akiyoshi; Koshiyama, Tatsuya; Tsubokawa, Tetsuro (2005). "High-Efficiency Color and White Organic Light-Emitting Devices Prepared on Flexible Plastic Substrates". *Japanese Journal of Applied Physics* **44**: 608. Bibcode:2005JaJAP..44..608M. doi:10.1143/JJAP.44.608.
- [79] Mikami, Akiyoshi; Nishita, Yusuke; Iida, Yoichi (2006). "35-3: High Efficiency Phosphorescent Organic Light-Emitting Devices Coupled with Lateral Color-Conversion Layer". *SID Symposium Digest of Technical Papers* **37**: 1376. doi:10.1889/1.2433239.
- [80] "OLED Sealing Process Reduces Water Intrusion and Increases Lifetime". *Georgia Tech Research News*. 2008-04-23.
- [81] <http://www.oled-info.com/displaymate-gs5-display-best-mobile-display-ever-outperforming-all-previous>
- [82] Stokes, Jon. (2009-08-11) This September, OLED no longer "three to five years away". Arstechnica.com. Retrieved 2011-10-04.
- [83] Michael Kanellos, "Start-up creates flexible sheets of light", CNet News.com, December 6, 2007. Retrieved 20 July 2008.
- [84] "Philips Lumiblades". Lumiblade.com. 2009-08-09. Retrieved 2009-08-17.
- [85] Session Border Controller. Tmcnet.com (2011-09-13). Retrieved 2012-11-12.
- [86] http://www.oled-info.com/universal_display_udc

- [87] Electronic News, OLEDs Replacing LCDs in Mobile Phones, April 7, 2005. Retrieved July 28, 2007.
- [88] "HTC ditches Samsung AMOLED display for Sony's Super LCDs". *International Business Times*. 2010-07-26. Retrieved 2010-07-30.
- [89] "Google Nexus S to feature Super Clear LCD in Russia (and likely in other countries, too)". *UnwiredView.com*. 2010-12-07. Retrieved 2010-12-08.
- [90] "ANWELL: Higher profit, higher margins going forward". *nextinsight.com*. 2007-08-15.
- [91] "AUO". *OLED-Info.com*. 2012-02-21.
- [92] "Chi Mei EL (CMEL)". *OLED-Info.com*.
- [93] "LG OLEDs". *OLED-Info.com*.
- [94] "OLED companies". *OLED-info.com*.
- [95] Rawlings, John (2010-08-07). "OLED Shearwater Predator Dive Computer Review". *AtlasOmega Media*. Retrieved 2013-04-10.
- [96] Tourish, Jeff. "Shearwater Predator CCR Computer". *Advanced Diver Magazine*. Retrieved 2013-04-10.
- [97] "DuPont Creates 50" OLED in Under 2 Minutes". *toms-guide.com*. Retrieved 2010-06-10.
- [98] "DuPont Delivers OLED Technology Scalable for Television". *www2.dupont.com*. 2010-05-12. Retrieved 2010-05-12.
- [99] *OLED-Info.com*, Kodak Signs OLED Cross-License Agreement. Retrieved March 14, 2008.
- [100] Bendable smartphones aren't coming anytime soon, The Sydney Morning Herald, Ian King, 16 December 2013
- [101] <http://www.oled-info.com/samsung-accelerate-flexible-oled-development>
- [102] Cherenack, Kunigunde; Van Os, K.; Pieteron, L. (April 2012). "Smart photonic textiles begin to weave their magic". *Laser Focus World* **48** (4): 63.
- [103] "Samsung SDI – The world's largest OLED display maker". *Oled-info.com*. Retrieved 2009-08-17.
- [104] "Samsung, LG in legal fight over brain drain". *The Korea Times*. 2010-07-17. Retrieved 2010-07-30.
- [105] "Frost & Sullivan Recognizes Samsung SDI for Market Leadership in the OLED Display Market | Find Articles at BNET". *Findarticles.com*. 2008-07-17. Retrieved 2009-08-17.
- [106] "World's Largest 21-inch OLED for TVs from Samsung". *Physorg.com*. 2005-01-04. Retrieved 2009-08-17.
- [107] Robischon, Noah (2008-01-09). "Samsung's 31-Inch OLED Is Biggest, Thinnest Yet – AM-OLED". *Gizmodo*. Retrieved 2009-08-17.
- [108] Ricker, Thomas (2008-05-16). "Samsung's 12.1-inch OLED laptop concept makes us swoon". *Engadget*. Retrieved 2009-08-17.
- [109] "Samsung: OLED Notebooks In 2010". *Laptop News. TrustedReviews*. Retrieved 2009-08-17.
- [110] Takuya Otani, Nikkei Electronics (2008-10-29). "[FPDI] Samsung Unveils 0.05mm 'Flapping' OLED Panel – Tech-On!". *Techon.nikkeibp.co.jp*. Retrieved 2009-08-17.
- [111] "40-inch OLED panel from Samsung". *Hdtvinfo.eu* (2008-10-30)
- [112] "Samsung presents world's first and largest transparent OLED laptop at CES". 2010-01-07.
- [113] "CES: Samsung shows OLED display in a photo card". 2010-01-07.
- [114] "Samsung Super AMOLED Plus display announced". Retrieved 2011-01-06.
- [115] Boylan, Chris (2013-08-13). "Bring Out Your OLED: Samsung KN55S9C OLED TV Available Now for \$8999.99". *Big Picture Big Sound*. Retrieved 2013-08-13.
- [116] Alex Lane (6 September 2013). "John Lewis TV Gallery video: 4K and OLED from Samsung, Sony, LG and Panasonic". *Recombu*. Retrieved 26 September 2013.
- [117] Sam Byford (8 October 2013). "Samsung's Galaxy Round is the first phone with a curved display". *The Verge*. Vox Media, Inc. Retrieved 10 November 2013.
- [118] Sony XEL-1: The world's first OLED TV, *OLED-Info.com* (2008-11-17).
- [119] "Sony's Clie PEG-VZ90—the world's most expensive Palm?". *Engadget*. 2004-09-14. Retrieved 2010-07-30.
- [120] "MD Community Page: Sony MZ-RH1". *Minidisc.org*. 2007-02-24. Retrieved 2009-08-17.
- [121] "Sony NWZ-X1000-series OLED Walkman specs released". *Slashgear*. 2009-03-09. Retrieved 2011-01-01.
- [122] "Sony announces a 27-inch OLED TV". *HDTV Info Europe* (2008-05-29)
- [123] CNET News, Sony to sell 11-inch OLED TV this year, April 12, 2007. Retrieved July 28, 2007.
- [124] The Sony Drive XEL-1 OLED TV: 1,000,000:1 contrast starting December 1st, *Engadget* (2007-10-01).
- [125] "Sony claims development of world's first flexible, full-color OLED display". *Gizmo Watch*. 2007-05-25. Retrieved 2010-07-30.
- [126] Sony's 3.5- and 11-inch OLEDs are just 0.008- and 0.012-inches thin. *Engadget* (2008-04-16). Retrieved 2011-10-04.
- [127] (Display 2008) 0.3mm EL – 150 D impress.co.jp (2008-04-16)
- [128] Japanese firms team up on energy-saving OLED panels, *AFP* (2008-07-10).
- [129] Athowon, Desire (2008). "Sony Working on Bendable, Folding OLED Screens". *ITProPortal.com*.

- [130] “Sony OLED 3D TV eyes-on”. *Engadget*. Retrieved 2010-01-11.
- [131] Snider, Mike (2011-01-28). “Sony unveils NGP, its new portable gaming device”. *USA Today*. Retrieved 2011-01-27.
- [132] “Sony Professional Reference Monitor”. Sony. Retrieved 2011-02-17.
- [133] “Sony, Panasonic tying up in advanced TV displays”. June 25, 2012.
- [134] LG 15EL9500 OLED Television. Lg.com. Retrieved 2011-10-04.
- [135] LG announces 31” OLED 3DTV. Electricpig.co.uk (2010-09-03). Retrieved 2011-10-04.
- [136] LG’s 55-inch ‘world’s largest’ OLED HDTV panel is official, coming to CES 2012. Engadget (2011-12-25). Retrieved 2012-11-12.
- [137] . OLED TV LG (2010-09-03). Retrieved 2012-12-21.
- [138] “OLED TV: Best. Picture. Ever.”. CNET. September 16, 2014. Retrieved 2014-11-11.
- [139] <http://biz.yahoo.com/e/150126/oled8-k.html>
- [140] MITSUBISHI ELECTRIC News Releases Installs 6-Meter OLED Globe at Science Museum. Mitsubishielectric.com (2011-06-01). Retrieved 2012-11-12.
- [141] Coxworth, Ben (2011-03-31). Video Name Tags turn salespeople into walking TV commercials. Gizmag.com. Retrieved 2012-11-12.
- [142] Three Minutes of Video Every Broadcaster and Advertiser MUST SEE.avi – CBS Videos : Firstpost Topic – Page 1. Firstpost.com (2012-08-10). Retrieved 2012-11-12.
- [143] BMW wants to put super-efficient OLED tail lights on your next car, *Engadget*, 10 April 2014, Jon Fingas
- [144] Japanese company doubles diode panel’s life span, *Global Post*, 13 October 2014
- [145] From Molecules to Organic Light Emitting Diodes, Max Planck Institute for Polymer Research, 7 April 2015.
- [146] Kordt, Pascal et al. (2015). “Modeling of Organic Light Emitting Diodes: From Molecular to Device Properties”. *Advanced Functional Materials* **25** (13): 1955. doi:10.1002/adfm.201403004.

- Pascal Kordt et al., *Modeling of Organic Light Emitting Diodes: From Molecular to Device Properties*. *Advanced Functional Materials* **25**, Issue 13, pages 1955-1971. <http://dx.doi.org/10.1002/adfm.201403004>
- Shinar, Joseph (Ed.), *Organic Light-Emitting Devices: A Survey*. NY: Springer-Verlag (2004). ISBN 0-387-95343-4.
- Hari Singh Nalwa (Ed.), *Handbook of Luminescence, Display Materials and Devices*, Volume 1–3. American Scientific Publishers, Los Angeles (2003). ISBN 1-58883-010-1. Volume 1: Organic Light-Emitting Diodes
- Hari Singh Nalwa (Ed.), *Handbook of Organic Electronics and Photonics*, Volume 1–3. American Scientific Publishers, Los Angeles (2008). ISBN 1-58883-095-0.
- Müllen, Klaus (Ed.), *Organic Light Emitting Devices: Synthesis, Properties and Applications*. Wiley-VCH (2006). ISBN 3-527-31218-8
- Yersin, Hartmut (Ed.), *Highly Efficient OLEDs with Phosphorescent Materials*. Wiley-VCH (2007). ISBN 3-527-40594-1

22.12 External links

- Structure and working principle of OLEDs and electroluminescent displays
- Tutorial on the working principle of OLEDs at Ghent University
- MIT introduction to OLED technology (video)
- Historical list of OLED products from 1996 to present

22.11 Further reading

- P. Chamorro-Posada, J. Martín-Gil, P. Martín-Ramos, L.M. Navas-Gracia, *Fundamentos de la Tecnología OLED (Fundamentals of OLED Technology)*. University of Valladolid, Spain (2008). ISBN 978-84-936644-0-4. Available online, with permission from the authors, at the webpage: <http://www.scribd.com/doc/13325893/Fundamentos-de-la-Tecnologia-OLED>

Chapter 23

Solid-state lighting



LED lamp with E27 Edison screw.

Solid-state lighting (SSL) refers to a type of lighting that uses semiconductor light-emitting diodes (LEDs), organic light-emitting diodes (OLED), or polymer light-emitting diodes (PLED) as sources of illumination rather than electrical filaments, plasma (used in arc lamps such as fluorescent lamps), or gas.

The term "solid state" refers commonly to light emitted by solid-state electroluminescence, as opposed to incandescent bulbs (which use thermal radiation) or fluorescent tubes. Compared to incandescent lighting, SSL creates visible light with reduced heat generation or parasitic energy dissipation. Most common "white" LEDs convert blue light from a solid-state device to an (approximate) white light spectrum using photoluminescence, the same principle used in conventional fluorescent tubes.

The typically small mass of a solid-state electronic lighting device provides for greater resistance to shock and vibration compared to brittle glass tubes/bulbs and long, thin filament wires. They also eliminate filament evaporation, potentially increasing the life span of the illumination device.

Solid-state lighting is often used in traffic lights and is also used frequently in modern vehicle lights, street and parking lot lights, train marker lights, building exteriors, remote controls etc.^[1]

23.1 Industry-wide Effects of Solid-state Lighting

Solid-state lighting has introduced a strong foothold across most of the lighting industries, and the advancements of those industries allows for the growth and technological advancement of solid-state lighting overall. One specific area where solid-state lighting has advanced rapidly is the Entertainment Lighting industry, where the standard incandescent Tungsten-Halogen (TH) lamp is being replaced by lighting fixtures with a solid-state light source as opposed to incandescent or discharge sources. Solid state lighting fixtures for the Entertainment Lighting industry have created major industry awareness about power consumption, power and data distribution, generated heat and its effect on a venue, among others. Companies in the subset of Entertainment Lighting have adapted to meet customer demand for solid-state products; these companies have quickly adapted their product lines to offer a conglomerated mix of solid-state, incandescent, and discharge products accordingly.

Entertainment Lighting companies that have adapted their lines to the Solid-state lighting models include but are not limited to:

- Philips (Vari*Lite, Strand, Selecon)
- Martin Lighting
- High End Systems/BARCO
- Altman Lighting
- Chauvet Professional
- Electronic Theatre Controls (ETC)
- Clay Paky
- Elation Professional
- Ayrton Light (France)

23.2 See also

- LED lamp

- List of light sources
- Stage_lighting
- Light-emitting_diode
- L Prize
- OLED
- Nonimaging optics
- Smart lighting

23.3 References

- [1] California Sustainability Alliance Solid State Lighting, Received July 24th, 2010

23.4 Further reading

- *Assessment of Advanced Solid State Lighting*. National Academies Press. 2013.

23.5 External links

- EUROPEAN METROLOGY RESEARCH PROJECT - METROLOGY FOR SOLID STATE LIGHTING
- Solid State Lighting, International Energy Agency research project
- DOE SSL roadmap
- Lighting Research Center - Solid-State Lighting Program
- OLLA: finished European academic-industrial research project into OLED lighting
- OLED100.EU: successor to the OLLA project

Chapter 24

AMOLED



AMOLED used in Samsung Galaxy Note

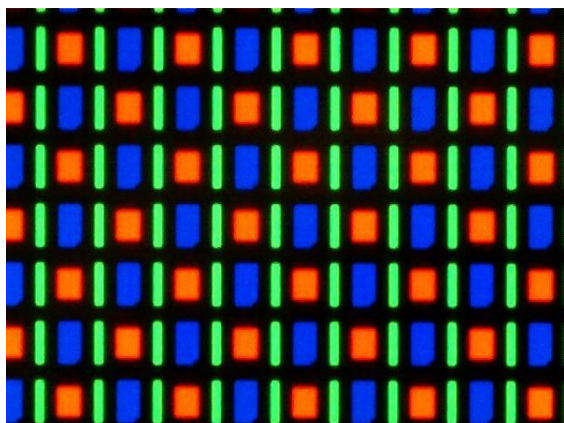

Magnified image of the AMOLED screen on the Nexus One smartphone using the RGBG system of the PenTile matrix family

AMOLED (active-matrix organic light-emitting diode) is a display technology for use in mobile devices and television. OLED describes a specific type of thin-film-display technology in which organic compounds form the electroluminescent material, and active matrix refers to the technology behind the addressing of pixels.

As of 2008, AMOLED technology is used in mobile phones, media players and digital cameras,^[1] and continues to make progress toward low-power, low-cost and large-size (for example, 40-inch) applications.^{[2][3][4]}

24.1 Design

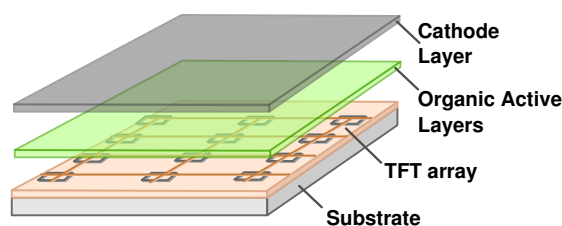

Schematic of an active-matrix OLED display

An AMOLED display consists of an active matrix of OLED pixels that generate light (luminescence) upon electrical activation that have been deposited or integrated onto a thin-film-transistor (TFT) array, which functions as a series of switches to control the current flowing to each individual pixel.^[5]

Typically, this continuous current flow is controlled by at least two TFTs at each pixel (to trigger the luminescence), with one TFT to start and stop the charging of a storage capacitor and the second to provide a voltage source at the level needed to create a constant current to the pixel, thereby eliminating the need for the very high currents required for passive-matrix OLED operation.^[6]

TFT backplane technology is crucial in the fabrication of AMOLED displays. The two primary TFT backplane technologies, namely polycrystalline silicon (poly-Si) and amorphous silicon (a-Si), are used today in AMOLEDs. These technologies offer the potential for fabricating the active-matrix backplanes at low temperatures (below 150 °C) directly onto flexible plastic substrates for producing flexible AMOLED displays.^[7]

24.2 Future development

Manufacturers have developed in-cell touch panels, integrating the production of capacitive sensor arrays in the AMOLED module fabrication process. In-cell sensor AMOLED fabricators include AU Optronics and Samsung. Samsung has marketed their version of this technology as “Super AMOLED”. Researchers at

DuPont used computational fluid dynamics (CFD) software to optimize coating processes for a new solution-coated AMOLED display technology that is cost and performance competitive with existing chemical vapor deposition (CVD) technology. Using custom modeling and analytical approaches, they developed short- and long-range film-thickness control and uniformity that is commercially viable at large glass sizes.^[8]

24.3 Comparison to other technologies

AMOLED displays provide higher refresh rates than their passive-matrix OLED counterparts, improving response time often to under a millisecond, and they consume significantly less power.^[9] This advantage makes active-matrix OLEDs well suited for portable electronics, where power consumption is critical to battery life.

The amount of power the display consumes varies significantly depending on the colour and brightness shown. As an example, one commercial QVGA OLED display consumes 0.3 watts while showing white text on a black background, but more than 0.7 watts showing black text on a white background, while an LCD may consume only a constant 0.35 watts regardless of what is being shown on screen.^[10] Because the black pixels actually turn off, AMOLED also has contrast ratios that are significantly better than LCD.

AMOLED displays may be difficult to view in direct sunlight compared with LCDs because of their reduced maximum brightness.^[11] Samsung's *Super AMOLED* technology addresses this issue by reducing the size of gaps between layers of the screen.^{[12][13]} Additionally, PenTile technology is often used to allow for a higher resolution display while requiring fewer subpixels than would otherwise be needed, often resulting in a display less sharp and more grainy compared with a non-pentile display with the same resolution.

The organic materials used in AMOLED displays are very prone to degradation over a relatively short period of time, resulting in color shifts as one color fades faster than another, image persistence, or burn-in.^{[14][15]}

Current demand for AMOLED screens is high, and, due to supply shortages of the Samsung-produced displays, certain models of HTC smartphones have been changed to use next-generation LCD displays from the Samsung and Sony joint-venture SLCD in the future.^[16]

Flagship smartphones sold as of 2011–12 use either Super AMOLED or IPS panel premium LCD. Super AMOLED displays, such as the one on the Galaxy Nexus and Samsung Galaxy S III have often been compared to IPS panel premium LCDs, found in the iPhone 4S, HTC One X, and Nexus 4.^{[17][18][19]} For example, according to ABI Research the AMOLED display found

in the *Motorola Moto X* draws just 92mA during bright conditions and 68mA while dim.^[20] On the other hand, compare with the IPS, the yield rate of Amoled is low, the cost is also higher.

24.4 Marketing terms

24.4.1 Super AMOLED

Super AMOLED is Samsung's term for an AMOLED display with an integrated digitizer, meaning that the layer that detects touch is integrated into the screen, rather than overlaid on top of it. According to Samsung, Super AMOLED reflects one-fifth as much sunlight compared to the first generation AMOLED.^{[21][22]} The display technology itself is not changed. Super AMOLED is part of the Pentile matrix family. It is sometimes abbreviated SAMOLED.

For the *Samsung Galaxy S III*, which reverted to Super AMOLED instead of the pixelation-free conventional RGB (non-PenTile) Super AMOLED Plus of its predecessor *Samsung Galaxy S II*, the S III's larger screen size encourages users to hold the phone further from their face to obscure the PenTile effect.^[23]

24.4.2 Super AMOLED Advanced

Super AMOLED advanced is a term marketed by Motorola to describe a brighter display than Super AMOLED screens, but also a higher resolution – qHD or 960 × 540 for Super AMOLED Advanced compared to WVGA or 800 × 480 for Super AMOLED. It also is 25% more energy efficient. Super AMOLED Advanced features PenTile, which sharpens subpixels in between pixels to make a higher resolution display, but by doing this, some picture quality is lost.^[24] This display equips the *Motorola Droid RAZR & HTC One S*.^[25]

24.4.3 Super AMOLED Plus

Super AMOLED Plus, first introduced with the *Samsung Galaxy S II* and *Samsung Droid Charge* smartphones, is a branding from Samsung where the PenTile RGBG pixel matrix (2 subpixels) used in Super AMOLED displays has been replaced with a traditional RGB RGB (3 subpixels) arrangement typically used in LC displays. This variant of AMOLED is brighter and therefore more energy efficient than Super AMOLED displays^[26] and produces a sharper, less grainy image because of the increased number of subpixels. In comparison to AMOLED and Super AMOLED displays, the Super AMOLED Plus displays are even more energy efficient and brighter. However, Samsung cited screen life and costs by not using Plus on the Galaxy S II's successor, the *Samsung Galaxy S III*.^[18]



The Samsung Galaxy S II, with a Super AMOLED Plus screen

24.4.4 HD Super AMOLED

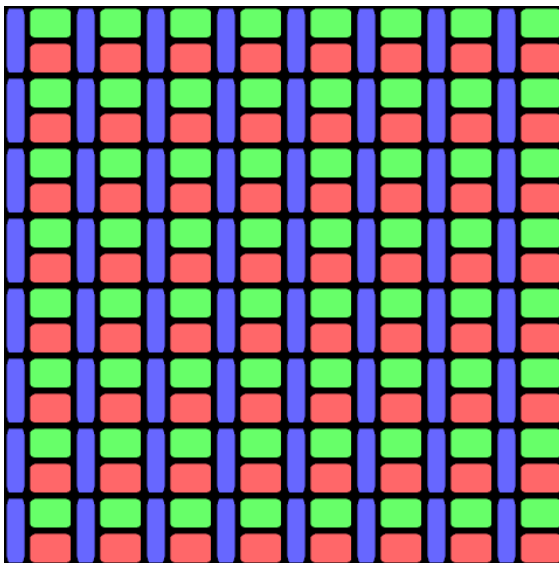

Galaxy Note II subpixels representation, based on 400X image of the Note II display^[27]

HD Super AMOLED is a branding from Samsung for an HD-resolution (>1280×720) Super AMOLED display. The first device to use it was the Samsung Galaxy Note. The Galaxy Nexus and the Galaxy S III both implement the HD Super AMOLED with a PenTile RGBG-matrix (2 subpixels/pixel), while the Galaxy Note II uses an RBG matrix (3 subpixels/pixel) but not in the standard 3 stripe arrangement.^[27]

24.4.5 HD Super AMOLED Plus

A variant of the Samsung Galaxy S3 using Tizen OS 1 was benchmarked using a non-pentile HD Super AMOLED



The Galaxy Nexus, with an HD Super AMOLED screen^[28]

Plus screen in 2012.^[29]

24.4.6 Full HD Super AMOLED

As featured on the Samsung Galaxy S4^[30] and Samsung Galaxy Note 3. It has the broadest color gamut of any mobile display of up to 97% of the Adobe RGB color space, hence making it a wide-gamut display.^{[31][32]}

24.4.7 Quad HD Super AMOLED

Quad HD Super AMOLED technology was first used by a company named AU Optronics^[33] in April 2014.^[34] After AU Optronics^[33] released their phone which used a Quad HD Super AMOLED screen, other companies such as Samsung^[35] released phones utilizing the technology such as the Samsung Galaxy S5 LTE-A.^[36]

24.4.8 Future

Future displays exhibited from 2011 to 2013 by Samsung have shown flexible, 3D, unbreakable, transparent Super AMOLED Plus displays using very high resolutions and in varying sizes for phones. These unreleased

prototypes use a polymer as a substrate removing the need for glass cover, a metal backing, and touch matrix, combining them into one integrated layer.^[37]

So far, Samsung plans on branding the newer displays as Youm.^[38]

Also planned for the future are 3D stereoscopic displays that use eye tracking (via stereoscopic front-facing cameras) to provide full resolution 3D visuals.

24.4.9 Comparison

Below is a mapping table of marketing terms versus resolutions and sub-pixel types. Note how the pixel density relates to choices of sub-pixel type.

24.5 Uses

Commercial devices using AMOLED include:

Phones

- Alcatel One Touch Idol Ultra (HD Super AMOLED)
- BlackBerry Q10
- BlackBerry Z30 (HD Super AMOLED)
- Cherry Mobile Cosmos X (HD Super AMOLED)
- Micromax a90s
- Micromax a90
- Micromax a315
- Micromax Canvas Hue
- BenQ-Siemens S88
- Dell Venue Pro
- Dell Venue 8 7000
- Gionee GN858 (Super AMOLED PLUS)
- Gionee GN868 (Super AMOLED plus)
- GIONEE GN878 (HD Super AMOLED)
- Gionee Elife E5 (HD Super AMOLED)
- GIONEE ELIFE S5.1 (HD Super AMOLED)
- GIONEE ELIFE S5.5 (Full HD Super AMOLED)
- HTC Desire (early models)
- HTC Droid Incredible
- HTC Legend
- HTC One S (Super AMOLED Advanced)
- HTC J (Super AMOLED Advanced)
- Lenovo S90 Sisley (HD Super AMOLED)
- LG Franklin Phone
- LG E-730
- LG G Flex (HD Plastic-OLED)
- LG G Flex 2 (Full HD Plastic-OLED)
- Micromax Superfone Pixel A90
- Motorola Moto X (HD Super AMOLED)
- Motorola Droid Ultra (HD Super AMOLED)
- Motorola Droid Maxx (HD Super AMOLED)
- Motorola Droid RAZR HD and RAZR Maxx HD
- Motorola Droid RAZR (Super AMOLED Advanced)
- Motorola Droid RAZR Maxx (Super AMOLED Advanced)
- Motorola Droid Turbo (Quad HD Super AMOLED)
- Moto X (2nd Generation) (1080p Super AMOLED)
- Motorola Moto X Pro (QHD Super AMOLED)
- Google Nexus One (Early models)
- Google Nexus S (Super AMOLED)
- Google Galaxy Nexus (HD Super AMOLED)
- Google Nexus 6 (Quad HD Super AMOLED)
- MP-809T (Full HD Super Amoled)
- Nokia 700 (CBD)
- Nokia 808 Pureview (CBD)
- Nokia C7-00
- Nokia C6-01 (CBD)
- Nokia E7-00 (CBD)
- Nokia Lumia 800 (CBD)
- Nokia Lumia 810 (CBD)
- Nokia Lumia 820 (CBD)
- Nokia Lumia 822 (CBD)
- Nokia Lumia 900 (CBD)
- Nokia Lumia 925 (CBD)
- Nokia Lumia 928 (CBD)

- Nokia Lumia 930
- Nokia Lumia 1020 (CBD)
- Nokia N8
- Nokia N85
- Nokia N86 8MP
- Nokia N9 (CBD)
- Nokia X7
- Pantech Burst
- QMobile Noir Z3
- Samsung ATIV S (HD Super AMOLED)
- Samsung ATIV SE (Full HD Super AMOLED®)
- Samsung AMOLED Beam SPH-W9600
- Samsung i7500 Galaxy
- Samsung Haptic Beam SPH-W7900
- Samsung SPH-m900 Moment
- Samsung i8910
- Samsung Jet
- Samsung Omnia 2
- Samsung Impression
- Samsung Rogue
- Samsung Transform
- Samsung Galaxy Note (HD Super AMOLED)
- Samsung Galaxy Note II (HD Super AMOLED)
- Samsung Galaxy Note 3 (Full HD Super AMOLED)
- Samsung Galaxy Round (Full HD Flexible Super AMOLED)
- Samsung Galaxy Note 3 Neo (HD Super AMOLED)
- Samsung Galaxy Note 4 (Quad HD Super AMOLED)
- Samsung Galaxy Note Edge (Edge Super AMOLED)
- Samsung Galaxy S (Super AMOLED)
- Samsung Galaxy S Advance (Super AMOLED)
- Samsung Galaxy Express (Super AMOLED Plus)
- Samsung Galaxy S II (Super AMOLED Plus)
- Samsung Galaxy S II Plus (Super AMOLED Plus)
- Samsung Galaxy S III (HD Super AMOLED)
- Samsung Galaxy S III neo (HD Super AMOLED)
- Samsung Galaxy S III Mini (Super AMOLED)
- Samsung Galaxy S4 (Full HD Super AMOLED)
- Samsung Galaxy S4 Mini (qHD Super AMOLED)
- Samsung Galaxy S4 zoom (qHD Super AMOLED)
- Samsung Galaxy S Plus (Super AMOLED)
- Samsung Galaxy S Blaze 4G (Super AMOLED)
- Samsung Galaxy S5 (Full HD Super AMOLED)
- Samsung Galaxy K Zoom (HD Super AMOLED)
- Samsung Galaxy Ace Style LTE (Super AMOLED)
- Samsung Galaxy Alpha (HD Super AMOLED)
- Samsung Galaxy A3 (qHD Super AMOLED)
- Samsung Galaxy A5 (HD Super AMOLED)
- Samsung Galaxy A7 (FULL HD Super AMOLED)
- Samsung Galaxy E5 (HD Super AMOLED)
- Samsung Galaxy E7 (HD Super AMOLED)
- Samsung Galaxy Nexus (HD Super AMOLED)
- Samsung Galaxy Gear (Super AMOLED)
- Samsung Gear 2 (Super AMOLED)
- Samsung Gear 2 Neo (Super AMOLED)
- Samsung Gear Fit (Curved Super AMOLED)
- Samsung Gear S (Curved Super AMOLED)
- Samsung Gear Live (Curved Super AMOLED)
- Samsung Droid Charge (Super AMOLED Plus)
- Samsung Wave S8500 (Super AMOLED)
- Samsung S8600 Wave III (Super AMOLED)
- Samsung Focus (Super AMOLED)
- Samsung Focus S (Super AMOLED Plus)
- Samsung Focus 2 (Super AMOLED)
- Samsung Omnia 7 (Super AMOLED)
- Samsung Omnia W (Super AMOLED)
- Samsung Omnia M (Super AMOLED)
- Samsung Infuse 4G (SGH-i997) (Super AMOLED Plus)
- Samsung Z (HD Super AMOLED)

- YotaPhone 2 (Full HD Super AMOLED)
- ZTE Blade (Initial Models)

Tablets

- docomo ARROWS Tab F-03G
- Samsung Galaxy Tab 7.7 (HD Super AMOLED Plus)
- Toshiba Excite 7.7 (HD Super AMOLED Plus)
- TOSHIBA REGZA AT570 7.7 (HD Super AMOLED Plus)
- Samsung Galaxy Tab S 8.4
- Samsung Galaxy Tab S 10.5

Portable music players

- Sony Walkman NWZ-X1000
- Sony Walkman NW-A855,A856,A857
- Cowon Z2
- Cowon S9
- Cowon J3
- Iriver Clix
- Iriver Spinn
- Samsung YP-M1
- Zune HD

Games consoles

- GP2X Wiz
- PlayStation Vita

Music production hardware

- Dave Smith Instruments “Tempest”
- Teenage Engineering OP-1

Digital cameras

- Olympus XZ-1
- Samsung EX1
- Samsung EX2F
- Samsung NX10
- Samsung NX11

- Samsung NX20
- Samsung NX100
- Samsung NX200
- Samsung NX210
- Samsung NX300
- Samsung NX1000
- Samsung NX1100
- Samsung NX2000
- Samsung WB2000
- Samsung WB650

24.6 References

- [1] Lee, Hyunkoo; Park, Insun; Kwak, Jeonghun; Yoon, Do Y.; Kallmann, Changhee Lee (2010). “Improvement of electron injection in inverted bottom-emission blue phosphorescent organic light emitting diodes using zinc oxide nanoparticles”. *Applied Physics Letters* **96**: 153306. doi:10.1063/1.3400224.
- [2] Kim, Yang Wan; Kwak, Won Kyu; Lee, Jae Yong; Choi, Wong Sik; Lee, Ki Yong; Kim, Sung Chul; Yoo, Eui Jin (2009). “40 Inch FHD AM-OLED Display with IR Drop Compensation Pixel Circuit”. *SID Symposium Digest of Technical Papers* **40**: 85. doi:10.1889/1.3256930.
- [3] Lee, Myung Ho; Seop, Song Myoung; Kim, Jong Soo; Hwang, Jung Ho; Shin, Hye Jin; Cho, Sang Kyun; Min, Kyoung Wook; Kwak, Won Kyu; Jung, Sun I; Kim, Chang Soo; Choi, Woong Sik; Kim, Sung Cheol; Yoo, Eu Jin (2009). “Development of 31-Inch Full-HD AMOLED TV Using LTPS-TFT and RGB FMM”. *SID Symposium Digest of Technical Papers* **40**: 802. doi:10.1889/1.3256911.
- [4] Hamer, John W.; Arnold, Andrew D.; Boroson, Michael L.; Itoh, Masahiro; Hatwar, Tukaram K.; Helber, Margaret J.; Miwa, Koichi; Levey, Charles I.; Long, Michael; Ludwicki, John E.; Scheirer, David C.; Spindler, Jeffrey P.; Van Slyke, Steven A. (2008). “System design for a wide-color-gamut TV-sized AMOLED display”. *Journal of the Society for Information Display* **16**: 3. doi:10.1889/1.2835033.
- [5] “Introduction to OLED Displays – Design Guide for Active Matrix OLED (AMOLED) Displays” (PDF). 4D Systems. 2008-05-22. Retrieved 2010-09-06.
- [6] Lin, Chih-Lung; Chen, Yung-Chih. “A Novel LTPS-TFT Pixel Circuit Compensating for TFT Threshold-Voltage Shift and OLED Degradation for AMOLED”. *IEEE Electron Device Letters* **28**: 129. doi:10.1109/LED.2006.889523.

- [7] Sarma, Kalluri R.; Chanley, Charles; Dodd, Sonia R.; Roush, Jared; Schmidt, John; Srdanov, Gordana; Stevenson, Matthew; Wessel, Ralf; Innocenzo, Jeffrey; Yu, Gang; O'Regan, Marie B.; MacDonald, W. A.; Eveson, R.; Long, Ke; Gleskova, Helena; Wagner, Sigurd; Sturm, James C. (2003). "Active-matrix OLED using 150°C a-Si TFT backplane built on flexible plastic substrate (Proceedings Paper)". *SPIE Proceedings* **5080**: 180. doi:10.1117/12.497638.
- [8] Reid Chesterfield, Andrew Johnson, Charlie Lang, Matthew Stainer, and Jonathan Ziebarth, "Solution-Coating Technology for AMOLED Displays", Information Display Magazine, January 2011.
- [9] Suyko, Alan. "Oleds Ready For The Mainstream." *Electronics News* (2009): 20. *Associates Programs Source Plus*. Web. 9 Dec. 2011.
- [10] Mian Dong; Choi, Y.-S.K; Lin Zhong (July 2009). "Power modeling of graphical user interfaces on OLED displays". *Design Automation Conference, 2009. DAC '09. 46th ACM/IEEE (IEEE)*: 652–657.
- [11] Tim Carmody Email Author. "How Super AMOLED displays work". *Wired.com*. Retrieved 2012-10-10.
- [12] "What Are The Benefits Of Using The Super AMOLED Display In My SGH-t959 (Vibrant) Phone?". *Samsung*. 2010-07-15. Retrieved 2010-09-07.
- [13] "Big is beautiful". *The Age*. 2010-08-12. Archived from the original on 29 August 2010. Retrieved 2010-09-07.
- [14] Ashtiani, Shahin J.; Reza Chaji, G.; Nathan, Arokia. "AMOLED Pixel Circuit With Electronic Compensation of Luminance Degradation". *Journal of Display Technology* **38**: 36. doi:10.1109/JDT.2006.890711.
- [15] US 7352345, Chun-huai Li, "Driving apparatus and method for light emitting diode display", issued 2008-04-01
- [16] Construction of new production facilities in 2011 will increase the production of AMOLED screens to cope with demand.
- [17] <http://www.digitaltrends.com/mobile/amoled-vs-lcd-which-screen-is-best-for-your-phone/>
- [18] <http://www.androidpit.com/super-amoled-vs-retina-display>
- [19] <http://techcrunch.com/2012/11/02/nexus-4-review-not-exactly-perfect-but-close-enough-for-me/>
- [20] Google/Motorola Mobility Display a Bright Efficient Future, ABI Research
- [21] "Samsung Smartphones | Technology". *Samsung.com*. 2012-01-06. Retrieved 2012-10-10.
- [22] "Super AMOLED". *Oled-info.com*. Retrieved 2012-10-10.
- [23] Sakr, Sharif (25 March 2012). "Samsung Galaxy S III review". *Engadget*. Retrieved February 6, 2013.
- [24] "Super AMOLED Advanced.". Retrieved March 24, 2014.
- [25] "DROID RAZR – Thinnest 4G LTE Android Smartphone – Motorola Mobility LLC. USA". Retrieved 27 November 2012.
- [26] "<http://www.oled-info.com/super-amoled-plus>". *OLED-Info*. Retrieved 23 August 2011.
- [27] "Galaxy Note 2: Display hat keine PenTile-Matrix | Best-BoyZ". *Bestboyz.de*. 2012-08-30. Retrieved 2012-10-10.
- [28] "Galaxy Nexus – Android 4. 0 Smartphone – SAMSUNG UK – OVERVIEW" (in Ukrainian). *Samsung.com*. Retrieved 2012-10-10.
- [29] <http://www.engadget.com/2012/09/22/wifi-alliance-certificate-teases-tizen-flavored-galaxy-s3/>
- [30] <http://www.samsung.com/global/microsite/galaxys4/lifetask.html#>
- [31] <http://sammyhub.com/2013/06/10/ul-certifies-samsungs-full-hd-amoled-display/>
- [32] http://www.displaymate.com/Galaxy_S4_ShootOut_1.htm
- [33] https://en.wikipedia.org/wiki/AU_Optronics#Products
- [34] <http://www.androidauthority.com/quad-hd-amoled-au-optronics-367542/>
- [35] <https://en.wikipedia.org/wiki/Samsung>
- [36] https://en.wikipedia.org/wiki/Samsung_Galaxy_S_series#cite_note-27
- [37] <http://www.engadget.com/2011/12/05/samsung-teases-flexible-transparent-display-in-concept-video/>
- [38] <http://www.engadget.com/2013/01/09/samsung-names-flexible-oled-display-series-youm-shows-prototype/>

24.7 External links

- Craig Freudenrich. Types of OLEDs: Passive and Active Matrix at HowStuffWorks

Chapter 25

Light-emitting electrochemical cell

A **light-emitting electrochemical cell (LEC or LEEC)** is a solid-state device that generates light from an electric current (electroluminescence). LEC's are usually composed of two metal electrodes connected by (e.g. sandwiching) an organic semiconductor containing mobile ions. Aside from the mobile ions, their structure is very similar to that of an organic light-emitting diode (OLED).

LECs have most of the advantages of OLEDs, as well as additional ones:

- The device does not depend on the difference in work function of the electrodes. Consequently, the electrodes can be made of the same material (e.g., gold). Similarly, the device can still be operated at low voltages.^{[1][2]}
 - Recently developed materials such as graphene^[3] or a blend of carbon nanotubes and polymers^[4] have been used as electrodes, eliminating the need for using indium tin oxide for a transparent electrode.
- The thickness of the active electroluminescent layer is not critical for the device to operate. This means that:
 - LECs can be printed^[5] with relatively inexpensive printing processes (where control over film thicknesses can be difficult).
 - Internal device operation can be observed directly.^[6]

25.1 History

While electroluminescence had been seen previously in similar devices, the invention of the polymer LEC is attributed to Pei et al.^[7] Since then, numerous research groups and a few companies have worked on improving and commercializing the devices.

In 2012 the first inherently stretchable LEEC using an elastomeric emissive material (at room temperature) was reported. Dispersing an ionic transition metal complex into an elastomeric matrix enables the fabrication of intrinsically stretchable light-emitting devices that possess

large emission areas (~175 mm²) and tolerate linear strains up to 27% and repetitive cycles of 15% strain. This work demonstrates the suitability of this approach to new applications in conformable lighting that require uniform, diffuse light emission over large areas.^[8]

In 2012 fabrication of organic light-emitting electrochemical cells (LECs) using a roll-to-roll compatible process under ambient conditions was reported.^[9]

25.2 See also

- Electrochemical cell
- Electrochemiluminescence
- Light-emitting diode
- Organic light-emitting diode
- Photoelectrolysis

25.3 References

- [1] Gao, J.; Dane, J. (2003). "Planar Polymer Light-Emitting Electrochemical Cells with extremely Large Interelectrode Spacing". *Applied Physics Letters* **83** (15): 3027. doi:10.1063/1.1618948.
- [2] Shin, J.-H.; Dzwilewski, A.; Iwasiewicz, A.; Xiao, S.; Fransson, Å.; Anka, G. N.; Edman, L. (2006). "Light Emission at 5 V from a Polymer Device with a Millimeter-Sized Interelectrode Gap". *Applied Physics Letters* **89** (1): 013509. doi:10.1063/1.2219122.
- [3] Matyba, P.; Yamaguchi, H.; Eda, G.; Chhowalla, M.; Edman, L.; Robinson, N. D. (2010). "Graphene and Mobile Ions: The Key to All-Plastic, Solution-Processed Light-Emitting Devices". *ACS Nano* **4** (2): 637–42. doi:10.1021/nn9018569. PMID 20131906.
- [4] Yu, Z.; Hu, L.; Liu, Z.; Sun, M.; Wang, M.; Grüner, G.; Pei, Q. (2009). "Fully Bendable Polymer Light Emitting Devices with Carbon Nanotubes as Cathode and Anode". *Applied Physics Letters* **95** (20): 203304. doi:10.1063/1.3266869.

- [5] Mauthner, G.; Landfester, K.; Kock, A.; Bruckl, H.; Kast, M.; Stepper, C.; List, E. J. W. (2008). "Inkjet Printed Surface Cell Light-Emitting Devices from a Water-Based Polymer Dispersion". *Organic Electronics* **9** (2): 164–70. doi:10.1016/j.orgel.2007.10.007.
- [6] Gao, J.; Dane, J. (2004). "Visualization of Electrochemical Doping and Light-Emitting Junction Formation in Conjugated Polymer Films". *Applied Physics Letters* **84** (15): 2778. doi:10.1063/1.1702126.
- [7] Pei, Q. B.; Yu, G.; Zhang, C.; Yang, Y.; Heeger, A. J. (1995). "Polymer Light-Emitting Electrochemical-Cells". *Science* **269** (5227): 1086–8. doi:10.1126/science.269.5227.1086. PMID 17755530.
- [8] Filiatrault, H. L.; Porteous, G. C.; Carmichael, R. S.; Davidson, G. J. E.; Carmichael, T. B. (2012). "Stretchable Light-Emitting Electrochemical Cells Using an Elastomeric Emissive Material". *Advanced Materials* **24** (20): 2673–8. doi:10.1002/adma.201200448.
- [9] Sandström, A.; Dam, H. F.; Krebs, F. C.; Edman, L. (2012). "Ambient Fabrication of Flexible and Large-Area Organic Light-Emitting Devices Using Slot-Die Coating" (PDF). *Nature Communications* **3**: 1002. doi:10.1038/ncomms2002.

Chapter 26

Electroluminescent wire

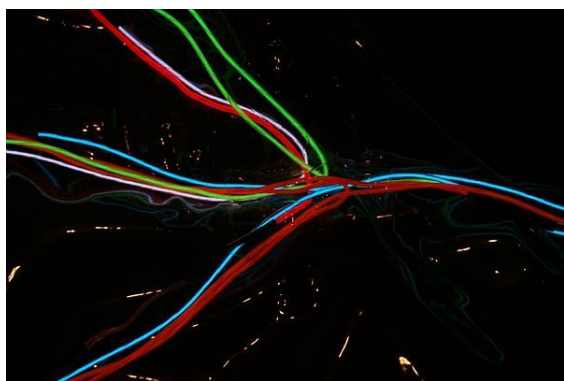

Close up of EL-Wire of a variety of colors



EL-Wire Project

Electroluminescent wire (often abbreviated as **EL wire**) is a thin copper wire coated in a phosphor which glows when an alternating current is applied to it. It can be used in a wide variety of applications—vehicle and/or structure decoration, safety and emergency lighting, toys, clothing etc.—much as rope light or Christmas lights are often used. Unlike these types of strand lights, EL wire is not a series of points, but produces a 360 degree unbroken line of visible light. Its thin diameter makes it flexible and ideal for use in a variety of applications such as clothing or costumes.^[1]

26.1 Structure

EL wire's construction consists of five major components. First is a solid-copper wire core, coated with phosphor. A very fine wire or pair of wires is spiral-wound around the phosphor-coated copper core and then the outer ITO conductive coating is evaporated on. This fine wire is electrically isolated from the copper core. Surrounding this "sandwich" of copper core, phosphor, and fine copper wire is a clear PVC sleeve. Finally, surrounding this thin, clear PVC sleeve is another clear, colored translucent, or fluorescent PVC sleeve.

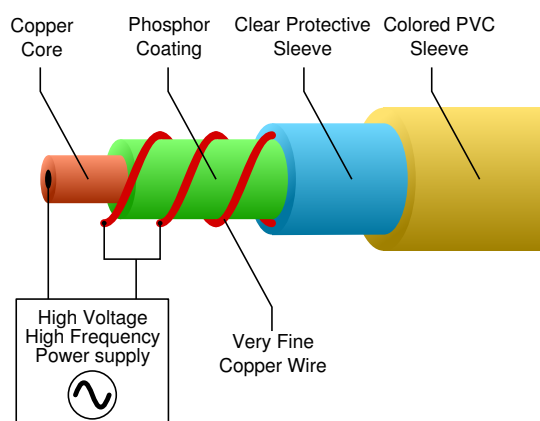

Diagram of EL-Wire

An alternating current electric potential of approximately 90 to 120 volts at about 1000 Hz is applied between the copper core wire and the fine wire that surrounds the copper core. The wire can be modeled as a coaxial capacitor with about 1 nF of capacitance per foot, and the rapid charging and discharging of this capacitor excites the phosphor to emit light. The colors of light that can be produced efficiently by phosphors are limited, so many types of wire use an additional fluorescent organic dye in the clear PVC sleeve to produce the final result. These organic dyes produce colors like red and purple when excited by the blue-green light of the core.

A resonant oscillator is typically used to generate the high voltage drive signal. Because of the capacitance load of the EL wire, using an inductive (coiled) transformer

makes the driver a tuned LC oscillator, and therefore very efficient. The efficiency of EL wire is very high, and thus a few hundred feet of EL wire can be driven by AA batteries for several hours.

In recent years, the LC circuit has been replaced for some applications with a single chip switched capacitor inverter IC such as the Supertex HV850, this can run 1 foot of angel hair wire at high efficiency suitable for solar lanterns and other safety applications. The other advantage of these chips is that the control signals can be derived from a microcontroller so brightness and colour can vary depending on battery state or ambient temperature.

EL wire in common with other types of EL device does have limitations; at high frequency it dissipates a lot of heat, and that can lead to breakdown and loss of brightness over time. There is also a voltage limit, the typical wire breaks down at around 180V p-p so if using an unregulated transformer back to back zeners and series current limiting resistor is essential.

In addition EL sheet and wire can sometimes be used as a touch sensor as compressing the capacitor will change its value,^[2]

26.2 Sequencers

EL wire sequencers can flash electroluminescent wire, or *EL wire*, in sequential patterns. EL wire requires a low-power, high-frequency *driver* to cause the wire to illuminate. Most EL wire drivers simply light up one strand of EL wire in a constant-on mode, and some drivers may additionally have a blink or strobe mode. A sound-activated driver will light EL wire in synchronization to music, speech, or other ambient sound, but an EL wire sequencer will allow multiple lengths of EL wire to be flashed in a desired sequence. The lengths of EL wire can all be the same color, or a variety of colors.

The images above show a sign that displays a telephone number, where the numbers were formed using different colors of EL wire. There are ten numbers, each of which is connected to a different channel of the EL wire sequencer.^[3]

The sequencer pictured is the Cat-09 2 to 10 channel sequencer developed by Cool Neon, a distributor of EL wire.

Like EL wire drivers, sequencers are rated to drive (or power) a range or specific length of EL wire. For example, using a sequencer rated for 1.5 to 14 meters (5 to 45 feet), if less than 1.5m is used, there is a risk of burning out the sequencer, and if more than 14m is used, the EL wire will not light as brightly as intended.

There are commercially available EL wire sequencers capable of lighting three, four, five, or ten lengths of EL wire. There are professional and experimental sequencers with many more than ten channels, but for most applica-

tions, ten channels is enough. Sequencers usually have options for changing the speed, reversing, changing the order of the sequence, and sometimes, to change whether the first wires remain lit or go off as the rest of the wires in the sequence are lit. EL wire sequencers tend to be smaller than a pack of cigarettes and most are powered by batteries. This versatility lends to the sequencers' use at nighttime events where mains electricity is not available.

26.2.1 Applications

By arranging each strand of EL wire into a shape slightly different from the previous one, it is possible to create animations using EL wire sequencers. EL wire sequencers are also used for costumes and have been used to create animations on various items such as kimonos, purses, neckties, and motorcycle tanks. They are increasingly popular among artists, dancers,^[4] maker culture, and similar creative communities, such as exhibited in the annual Burning Man alt-culture festival.

26.3 References

- [1] "EL Wire – Electroluminescent Wire". Elwire.net. Retrieved December 14, 2012.
- [2] <https://www.youtube.com/watch?v=5ORP-hOTBLk>
- [3] The telephone number has been obscured in both photos in order to comply with Wikipedia guidelines.
- [4] "The dancers who light up the stage with wearable tech". BBC News. Retrieved October 31, 2014.

5,753,381 US Patent, Electroluminescent Filament

26.4 External links

- How Electroluminescent (EL) Wire Works, by Joanna Burgess // How Stuff Works
- How to Make an EL Wire Cowboy Hat, by Matt Smith // GlowCulture.com

Chapter 27

Field-induced polymer electroluminescent technology

Field-induced polymer electroluminescent (FIPEL) technology is a low power electroluminescent light source. Three layers of moldable light-emitting polymer blended with a small amount of carbon nanotubes glow when an alternating current is passed through them. The technology can produce white light similar to that of the Sun, or other tints if desired.^[1] It is also more efficient than compact fluorescent lamps in terms of the energy required to produce light.^{[1][2][3]} As cited from the Carroll Research Group at Wake Forest University, “To date our brightest device - without output couplers - exceeds 18,000 cd/m².” This confirms that FIPEL technology is a viable solution for area lighting.^[4]

FIPEL lights are different from LED lighting, in that there is no junction. Instead, the light emitting component is a layer of polymer containing an iridium compound which is doped with multi-wall carbon nanotubes. This planar light emitting structure is energized by an AC field from insulated electrodes.^[5] The lights can be shaped into many different forms, from mimicking conventional light bulbs to unusual forms such as 2-foot-by-4-foot flat sheets and straight or bent tubes.^[6] The technology was developed by a team headed by Dr. David Carroll of Wake Forest University in Winston-Salem, North Carolina.^[7]

mer electroluminescence”. *Organic Electronics* **14** (1): 8–18. doi:10.1016/j.orgel.2012.10.017.

- [3] Dillow, Clay (3 December 2012). “New Lighting Could Replace Fluorescents, CFLs, and LEDs As The Light Source Of The Future”. Popsi.com. Retrieved 2013-01-06.
- [4] CarrollResearch. http://users.wfu.edu/carroldl/Lighting_Display.html". *Missing or empty |title= (help)*;
- [5] Manners, David (6 December 2012). “Fipels Take On LEDs”. Electronics Weekly. Retrieved 2013-01-06.
- [6] “New light bulbs made of glowing plastic”. *Fox News (TechNewsDaily)*. 4 December 2012. Retrieved 2013-01-06.
- [7] Neal, Katie (3 December 2012). “Taking the buzz out of office lights”. *News Center*. Wake Forest University, Office of Communications and External Relations. Retrieved 2012-12-04.

27.1 See also

- Conductive polymer#Electroluminescence

27.2 Notes

- [1] McGrath, Matt (3 December 2012). “Plastic bulb development promises better quality light”. *BBC News*. Retrieved 2013-01-06.
- [2] Chen, Yonghua; Smith, Gregory M.; Loughman, Eamon; Li, Yuan; Nie, Wanyi; Carroll, David L. (January 2013). “Effect of multi-walled carbon nanotubes on electron injection and charge generation in AC field-induced poly-

27.3 Text and image sources, contributors, and licenses

27.3.1 Text

- Lamp (electrical component)** *Source:* [http://en.wikipedia.org/wiki/Lamp%20\(electrical%20component\)?oldid=659915135](http://en.wikipedia.org/wiki/Lamp%20(electrical%20component)?oldid=659915135) *Contributors:* Heron, Zanimum, Mac, Glenn, Radiojon, Mintleaf~enwiki, Archenzo, Stevietheman, Chowbok, Antandrus, Jossi, Discospinster, Adam850, Paul August, ESkog, Etnoy, Tritium6, Alansohn, Atlant, Snowolf, Wtshymanski, BlastOButter42, Shreevatsa, BillC, Jacobolus, Commander Keane, Chochopek, Bennetto, Kbdank71, Edison, Josh Parris, Rjwilmsi, Jake Wartenberg, Nneonneo, Boccobrock, Gurch, Ayla, BitterMan, Lmatt, Srleffler, Mortenoesterlundjoergensen, YurikBot, StuffOfInterest, The Storm Surfer, Akamad, Gustavb, Larsobrien, Searchme, Zzuuzz, Tabby, Doktor Waterhouse, Allens, Bweenie, DVD R W, SmackBot, Reedy, McGeddon, Edgar181, Ohnoitsjamie, Chris the speller, EdgeOfEpsilon, Madman91, Addshore, Dreadstar, Mwtoews, SpiderJon, Dogears, Bige1977, Žiga, Tlesher, 16@r, Stwalkerster, Mattabat, Hu12, Hetar, Tony Fox, Azi568, Tawkerbot2, Deon, Unmitigated Success, Cydebot, Mato, Gogo Dodo, Flowerpotman, Donaltheirst, Asenine, Editor at Large, SpK, Epr123, Daniel, AndyjSmith, Siawase, Escarbot, Trengarasu, Mentifisto, AntiVandalBot, Widefox, Erik Baas, QuiteUnusual, Ilovewikipedia101, Chgros, Myanw, AjaaniSherisu, Res2216firestar, JAnDbot, Andonic, Greensburger, Bongwarrior, VoABot II, JWGreen, Abstract Idiot, CTF83!, Animum, Vssun, SmokeySteve, Jim.henderson, Smokizky, Siliconov, J.delanoy, Zlongbow, Chefs fridge, Itzcuauhlti, Ginsengbomb, WarthogDemon, Ian.thomson, Daniel-James, Katalaveno, McSly, Afluegel, KCinDC, Sunderland06, Cometstyles, Idioma-bot, Deor, Philip Trueman, Seraphim, Dlae, Dudenarmo, Jediknil, Falcon8765, Headhunter747, Biscuitin, Rfts, Upright citizen, Tiddly Tom, Calabraxthis, Arda Xi, Interchange88, Flyer22, Antonio Lopez, AngelOfSadness, LEDtronics, Macy, Dillard421, Jay Turner, Maelgwnbot, Mattycl, CampKohler, Barkjon, ClueBot, Foxj, DanielDeibler, Redcliffe92, Meandevil02.2, Boffinbox, Puchiko, Editor70, Mkativerata, Excirial, NuclearWarfare, Thehelpfulone, Aitias, Footballfan190, Versus22, Supersymetrie, SeXyMaMmAlolz, AgnosticPreachersKid, Stickee, Lilman bmoney, Radioactivebananaapeel, RYAN RABIEZ., NellieBly, ZooFari, MystBot, Deanyl2345, Menthaxpiperita, Good Olfactory, Kongoluongo, Maxwell?87, Addbot, Justaveragedave, American Eagle, Willking1979, Sooperpi, Mr. Wheely Guy, Frog4drama, Fluffernutter, Bobtrezeguet, West.andrew.g, KaiKemmann, G Man144, Tide rolls, Pietrow, Yobot, Tohd8BohathuGh1, THEN WHO WAS PHONE?, AnomieBOT, Jim1138, IRP, Pyrrhus16, AdjustShift, Sheen2112, GB fan, ShadowBlindx, Anuuu, Chyangravendick, Atrain472, Teriyakistix, Teddks, Adge123, Anna Frodesiak, Djmp81394, Shadowjams, Erik9bot, Hilwin1, Aleman89, Tom8norman, To be edited001, Deanthebigbean, Renameme, FoxBot, Ticklewickleukulele, Vrenator, MrX, Allen4names, MegaSloth, JonneyAmerica, Ripchip Bot, EmausBot, Ji30i30, Statstudent12, Zagrepčan, Tommy2010, Fiveoclock-somewere, Bobdole12122, Grunny, Tuffmuffin6969, Gray eyes, ClueBot NG, LogX, Qazwsxedcrfvtgqwertasfdgzcxcvb, Widr, Vagobot, Frosty, Delian5eva, Tentinator, Kaperskyuser, Wyn.junior, JaunJimenez, Mr-tayto-xxx, Anustart 69, Carlos spicysausage, Crazycatman82, Leximartin232, Wayscum, Buupsuupcuup, Ksouba and Anonymous: 224
- Incandescent light bulb** *Source:* <http://en.wikipedia.org/wiki/Incandescent%20light%20bulb?oldid=659742743> *Contributors:* Derek Ross, Eloquence, Mav, Robert Merkel, The Anome, Tarquin, Malcolm Farmer, Mark, Ed Poor, Codeczero, Rmhermen, Enchanter, Oliverkroll, Ghakko, SimonP, DavidLevinson, Anthere, Europrobe, David spector, Heron, Mintguy, Dwheeler, Isis~enwiki, Topory, Edward, Patrick, Infrogmation, Michael Hardy, Liftarn, Gabbe, Stephen C. Carlson, Tannin, Tiles, Minesweeper, Ahoerstemeier, Stevenj, Jdforrester, Darkwind, Iain, Amcaja, Jll, Glenn, Bogdangiusca, CIPHERgoth, Viveka~enwiki, Focus mankind~enwiki, Mulad, Jonadab~enwiki, Reddi, Stone, Polymath, Doradus, Radiojon, TpbBradbury, Furrykef, Hyacinth, Grendelkhan, Saltine, ZeWrestler, EthanL, Fibonacci, Omegatron, Ed g2s, Phoebe, Kwantus, Dpbsmith, Gypsum Fantastic, Secretlondon, Jerzy, Anjouli, Jeffq, Shantavira, Denelson83, Jni, Twang, Donarreiskoffer, AlexPlank, Robbot, Adamahill, Hankwang, Pigsonthewing, RedWolf, Smallweed, Calmypal, Babbage, Spin2cool, Academic Challenger, Intangir, Hadal, LX, Mdrejhon, Asparagus, Diberry, SaltyPig, Jleedev, MikeCapone, Dina, Jooler, David Gerard, Giftlite, Achurch, KevinJr42, K igor k, TOttenville8, Massysset, BenFrantzDale, Popup~enwiki, Tom harrison, Fastfission, Orpheus, Ds13, Everyking, Markus Kuhn, David Johnson, AJim, Robert Weemeyer, Zoney, Solipsist, FooBar, Jbrooks, Bobblewik, Isidore, Stevietheman, Gadium, Utcursch, Geni, Pearbonn, Antandrus, Beland, Phe, Kiteinthewind, SimonArlott, Kesac, Icairms, Clarknova, Sfoskett, PaschalNee, Iantresman, Gary D, CoyneT, Joyous!, Imjustmatthew, Kevin Rector, Ratiocinate, Demiurge, Deglr6328, Calwatch, Famartin, Lacrimosus, SYSS Mouse, Mike Rosoff, Freakofnurture, Archer3, DanielCD, Ming888, NathanHurst, Noisy, Discospinster, Rich Farmbrough, KillerChihuahua, Guanabot, Pjacob, Jpk, Filzstift, Adam850, Izogi, Ckelsh, Arthur Holland, Dbachmann, Pavel Vozenilek, Paul August, Cromis, JemelL, Rling, Jnestorius, Plugwash, Hayabusa future, Shanes, KuriosD, Art LaPella, RoyBoy, Aaronbrick, Semper discens, Causa sui, Tjic, Jtact, Bobo192, Grue, Nigelj, Spalding, Jfraser, Viriditas, Archfallhwy, Jhnteslade, Elipongo, Of~enwiki, Timl, Homerjay, Kjkolb, Darwinek, Photonique, PiccoloNamek, Twobells, Towel401, Idleguy, Haham hanuka, Krellis, Chicago god, Hooperbloom, Nsaa, QuantumEleven, Mroach, Jhd, Espoo, Rye1967, Akeshet, Musiphil, Alansohn, Atlant, Geke, AzaToth, PAR, Redfarmer, Hohum, Blobglob, Wtmitchell, Gdavidp, ProhibitOnions, Wtshymanski, Cburnett, Stephan Leeds, Staeiou, Amorymeltzer, Skatebiker, Versageek, DV8 2XL, Gene Nygaard, Deciheximal, Mattbrundage, Tobyc75, TheCoffee, Netkinetic, Gatewaycat, Feezy, Richard Arthur Norton (1958-), OwenX, Woohookitty, JarlaxleArtemis, RHaworth, Brunnock, Steven Luo, BillC, Bratsche, Davidkazuhiro, Lupinelawyer, Pol098, WadeSimMiser, Tckma, Tomilllis, Oldie~enwiki, Terence, Sengakang, GregorB, Zzyzx11, InitHello, Joe Beaudoin Jr., Prashanthns, Pencil Puffer, Rusty2005, Paxisimus, Mandarax, Tslucum, RedBLACKandBURN, Magister Mathematicae, Jclemens, Edison, Ciroa, Kafuffle, Sjö, Saperaud~enwiki, Coneslayer, Sjakalle, Rjwilmsi, AngusmcLellan, Nightscream, Strait, Bob A, Quiddity, Cuenca, JHMM13, Groomer, Scorchsaber, DonSiano, TPIRman, NeonMerlin, ElKevbo, Supreme geek overlord, Mintie, The wub, Bhadani, Dar-Ape, Yamamoto Ichiro, Old Moonraker, Latka, Margosbot~enwiki, NihilTres, Trekkie4christ, Who, Nivix, RexNL, Gurch, TheDJ, Maustrauser, Lmatt, Alphachimp, RockOfVictory, Srleffler, SVTCobra, King of Hearts, CJLL Wright, Chobot, Gwernol, Algebraist, The Rambling Man, YurikBot, Albanaco, Wavelength, TexasAndroid, Themepark, Hairy Dude, Dc1974, Jachin, Ppfk~enwiki, Phantomsteve, RussBot, Red Slash, Icarus3, Brianpirie, Jumbo Snails, Smedhaug, JabberWok, Ytrottier, Phlip, SpuriousQ, Bilky asko, Iammart, RadioFan2 (usurped), Hydrargyrum, GPS Pilot, Stephenb, Okedem, Tenebrae, Shaddock, Cryptic, Wimt, Bullzeye, Royalbroil, David R. Ingham, NawlinWiki, Injnera, Wiki alf, Bachrach44, AugieWest, Janke, Milo99, Dogcow, Irishguy, Brian Crawford, PeepP, Brabblebrex, SixSix, MakeChooChooGoNow, JHCaufield, Xompanthy, BOT-Superzerocool, Georgeslegloupier, DeadEyeArrow, Bota47, Jeh, Marc NL~enwiki, Alpha 4615, Tonywalton, Desertsnowman, FF2010, Zello, Scheinwerfermann, Light current, Zzuuzz, Bussiere~enwiki, Michaelcoyote, Theda, Closedmouth, Tabby, Arthur Rubin, JQF, Dspradau, StealthFox, Petri Krohn, Red Jay, Vicarious, Kevin, Spliffy, ArielGold, Jedwards05, WormNut, Junglecat, TLSuda, Moomoomoo, Mmcannis, Maxamegalon2000, Rehevkor, SkerHawx, Mejor Los Indios, DVD R W, Clreland, Eenu, Samwilson, robot, ChemGardener, Benhoyt, Yvwv, Planemad, SmackBot, Karlchwe, Amcbride, Hux, Herostratus, InverseHypercube, KnowledgeOfSelf, Hydrogen Iodide, Basil.bourque, Od Mishehu, Jim62sch, Thorseth, Sea diver, Jacek Kendysz, Jrockley, Eaglizard, Delldot, Nil Einne, Edgar181, Gilliam, Brianski, Ohnoitsjamie, Hmains, Betacommand, Jushi, Durova, Valley2city, TheDarkArchon, Comfortably Paranoid, Yankees76, Agateller, Persian Poet Gal, Bigfun, Jprg1966, Fluri, SchiffyThree, Hibernian, Victorgrigas, Neo-Jay, HubHikari, EdgeOfEpsilon, Patriarch, Baa, A. B., Ducaim, FredStrauss, Kebbs, Jeffreyarcand, Onceler, Trekphiler, Johnhacksack3d, Can't sleep, clown will eat me, AntiVan, Shalom Yechiel, V1adis1av, Chlewbob, Ahudson, Onorem, Locando, Rrburke, Stepho

wrs, VMS Mosaic, Xyzyplugh, Driids, Rsm99833, Kcordina, Midnightcomm, Jgoulden, Zirconscoot, Jmlk17, Cjk91, Emre D., Nakon, Kelly Chartier, VegaDark, Ian01, RaCha'ar, Rezecib, Dreadstar, TrogdorPolitiks, RandomP, Atom smith, KI, Matt Whyndham, DMacks, Kalathalan, Lph, Dogears, Ohconfucius, Bige1977, The undertow, Rklawton, Anlace, What no2000, Kuru, John, Sgfoote, BanditCat, Heimstern, Ocee, Nzgabriel, Shlomon, JoshuaZ, Linnormold, Mgiftanteu1, Zarniwoot, Peterlewis, Majorclanger, CoolKoon, Hanii Pupper, SuperciliousBivalve, MarkStuton, TeoWS, Slakr, Timmeh, Werdan7, Stwalkster, Beetstra, George The Dragon, Peytons, LACameraman, Samfreed, BrockF5, Fangfufu, Waggars, NJA, Ryulong, Ciand, KurtRaschke, Zapvet, Dacium, Vanished user tj4iniosefjoisdkwk4ej5, Hgrobe, Andreworkney, Hu12, Politepunk, BSI, Zisimos, Dead3y3, Iridescent, Joseph Solis in Australia, JoeBot, Slammer111, Barbarella, Yugyug, UncleDouggy, Igoldste, Tony Fox, CapitalR, Blehfu, Az1568, Courcelles, Linkspamremover, Throktar, Tawkerbot2, Metrofeed, Chetvorno, Elekas, Peterktan, IanWills, SkyWalker, Vitriden, JForget, Sakurambo, VoxLuna, Mikiemike, CmdrObot, Ale jrb, PorthosBot, Unionhawk, Scohoust, Smably, TTK2, Kushal one, CWY2190, Nbach, McVities, Joelholdsworth, Art10, Lironl, Oo7565, Funnyfarmofdoom, Cydebot, Korky Day, Slade24, Grahamec, MC10, Mato, Wingchild, Gogo Dodo, Anonymi, SetiHitchHiker, CorpX, New-Providence, Sadharan, Q43, Tawkerbot4, DumbBOT, Omexis, Ssilvers, Bungle, Dinnerbone, Mtpaley, Omicronpersei8, JodyB, -Justin-, Toasts, FrancoGG, JamesAM, Thijs!bot, Poorleno, Epr123, Bezking, PMG123, Overdriveagar, Gralo, Mojo Hand, Headbomb, Marek69, John254, Bobblehead, Electron9, Mattfiller, Doyley, RFlynn26, A.J.Chesswas, Dmbrown00, Hcobb, Binarybits, LajsikoniK, Escarbot, Dainis, Trengarasu, Mentifisto, AntiVandalBot, Luna Santin, Fnerchei, ASDFGHJKL, DarkAudit, MikeNY, Spencer, Jonathan Williams, Lonestar662p3, Raigedas, The man stephen, Gökhan, Sstucker, Res2216firestar, Ioeth, Serpent's Choice, JAnDbot, Harryzilber, Tony Myers, MER-C, Arch dude, Fetchcomms, Db099221, Wtoconnor, Ccrrcrr, Andonic, Sitethief, Greensburger, Krelborne, TAnthony, PhilKnight, Denimadept, Kerotan, LittleOldMe, .anacondabot, Acroterion, Pedro, Bongwarrior, VoABot II, JWGreen, Carlwev, Ferritecore, No substitute for you, JNW, JamesBWatson, Kakomu, Antipodean Contributor, Jéské Couriano, Stigmj, Inteligence, Jayfogle, Nyttend, Jmartinson, SparrowsWing, Catgut, Smarterchild 13, Ray112893, ArchStanton69, Blanko4, Loonymonkey, 28421u2232nfenfcenc, LorenzoB, Vssun, Dunham, Supreme Unmanifest, Glen, DerHexer, Joeyman365, Yeahsoo~enwiki, Monstrosity, TheRanger, Kesmet, I B Wright, Seba5618, September 11 suicide bomber, FisherQueen, Sasper, Hdt83, MartinBot, Sunnyboi14, PAK Man, Eternal Pink, Quickmythril, Arjun01, Mattjs, Reguiee, Jim.henderson, Nikpapag, Hellomistorgibbs, Rettetast, Uberninjaelephant, Bissinger, Jay Litman, Bus stop, Stonedonkey, Vox Rationis, Bobstupid123, Cairan, V.petcu, Pekaje, Hairchrm, LittleOldMe old, PrestonH, Johnibravo, Draffa, LedgendGamer, EdBever, AnonHat, BGOATDoughnut, J.delanoy, Captain panda, Pharaoh of the Wizards, Lohelennuk, Irishguy9221, Numbo3, Tntdj, Uncle Dick, User2073, Jesant13, Eliz81, Cocoaguy, Aphenry, Teh Ch8t, Daniel-James, MelindaSA, Cpiral, Acalamari, EH74DK, Everchanging02, Dispenser, Prattbrat, Jacarv, McSly, Suigintou, Woodega, Gurchzilla, GhostPirate, Smbdodgers, JDBarnhart, Vitamin77, Nickroxvote3, Sabrown100, NewEnglandYankee, Pterre, Aeravanath, SJP, Dheerav2, Gregfitzy, KCinDC, Pundit, 2help, Nukeitup2, Burzmali, Johnsmith1234567890, Ken g6, Agrofe, WikipediaSq, Plunkey, Td321, Qwaserdf25, Ronbo76, Yeostreme, Intangible2.0, Xiahou, Funandtrvl, Spellcast, 1812ahill, Deerparkscientist, Worp8d, Maxiskool, Vranak, Mattybobo, X!, Jobrien13057, Jake Wasdin, CWii, Johnfos, ABF, Shankar.ananthakrishnan, Jeff G., JohnBlackburne, Nburden, Seattle Skier, Rubyuser, Paxcoder, Ipearx, Barneca, Drummer91792, Philip Trueman, Qwertyg, Charleca, TXiKiBoT, Oshwah, GLPeterson, Petra87, Cosmic Latte, Sbjf, Sequites, Rei-bot, Junglepossum, James T. Miller, Ulfbastel, Cedric db, Qxz, Piperh, Olavn, Anna Lincoln, Hrothberht, Cheez freak777, Jason C.K., Sintaku, Clarince63, Martin451, Leafyplant, Ng.j, Zek160, Swankus2711, Canaima, Jackfork, LeaveSleaves, MikaNystrom, Jvbishop, XDXD, Heavenskid, WinTakeAll, Buffs, Don Braden, Nikosgreencookie, Eubulides, Tri400, BigDunc, Roland Kaufmann, Billinghurst, Jpeter-son101, Nick4634, Adam.J.W.C., Jediknil, Falcon8765, Enviroboy, TkerTimeSeeker, Aznpkwe, Burntsauce, Hypertony, Nikolasapoel, MikeyNolan, Spikybeagle, Jackyeo, Sevela.p, Greenraven6, Why Not A Duck, Agüeybaná, Daviddemarco99, Symane, LuigiManiac, Davidisdabomb, Bbb555, Imhiding23, BMAN44, Kbrose, ZoePettyfer, Callmebc, Fatdemon, Biscuittin, J. Naven, Madman, Zenlax, TJRC, Brenont, Jim77742, COOL ONWE, Cake44, Tiddly Tom, Natisgay1, Scarian, Jimboroni, ITBlair, Jauerback, Sakkura, Mr. Recycle, Richtea2007, Caltas, ConfuciusOrnis, SimonGriffindor, Irudyk, Yintan, Flintstonepearl, Dongo8888, Steve19steve, PROFESSOR LIGHT BULB, Purbo T, Zhong123, France3470, Keilana, Xenophon777, Flyer22, Tiptoety, Radon210, Robert - Northern VA, Swateste, Oda Mari, Doctor Light Bulb, Epitron, UMRK, JSpung, Mike Shepherd, Oxymoron83, Clarkr95, Antonio Lopez, Faradayplank, Nuttycon-conut, Bagatelle, Lightmouse, Tombomp, User5910, KathrynLybarger, SimonTrew, Justincannon4, Moletrouser, Buzzlightbulb, Svick, Bobzilla79, Ultramegaguy, Gav235, Flaadrom, Omccreary, Tonymk, Legionarius, MarkinBoston, Mygerardromance, Siskus, Barefoot-tomboy, Nn123645, Peanut73, Bow-LeggedMatador, Mrjkb, Benkenobi18, Atif.t2, GreenLaura, Beeblebrox, ClueBot, Robbiemuffin, UniQue tree, Jorg w busch, Snigbrook, The Thing That Should Not Be, Plastikspork, Jamilove, Dean Wormer, ImperfectlyInformed, Dp-muk, Bob Rocketz, Gargyzx, Wondernerd, Grouf, Franamax, Cp111, VQuakr, Mild Bill Hiccup, DanielDeibler, Skytopia, Wikikid, CounterVandalismBot, Baseball102, Redcliffe92, Estevoaei, Piledhigheranddeeper, Einstein47~enwiki, Boffinbox, Abcd4444, Lorielle~enwiki, Donbr, SuperBader, Manishearth, Rameal Hill, Excirial, Nymf, Jusdafax, Flippytheganster, Nathan.grocks, Monobi, LifeofFred, Jess-wah13, Vivio Testarossa, Gottadmit, Mindstalk, Keleighlynnoxoxo, Arjayay, Promethean, LarryMorseDCOhio, 842U, Pte117, Zachrush2, Razorflame, Ottawa4ever, M.boli, Thingg, Redrocketbot, Lolzorpsi, Aitias, Horselover Frost, MatthewAnderson707, Caramelapple, Versus22, Hola3165, Smarkflea, Sportskid11223344, Ubardak, SoxBot III, Egmontaz, TropicalMonkey, DumZiBoT, Arista ardhian, Al-chemist Jack, BarretB, XLinkBot, Strdst grl, Fastily, Delicious carbuncle, Spitfire, TaalVerbeteraar, Sponson, Rror, Turtleboy0, Little Mountain 5, Skarebo, Queen Breezey, NellieBly, Piemanpie, Alexius08, Subversive.sound, ZooFari, Guitarplaya23, HexaChord, Ad-dbot, Xp54321, American Eagle, Willking1979, Tcnv, Frigorator, Tanner123131, Uninformeddummy, 95mateusz, Ronhjones, Scorpian2816, Tarosic, I K Brunel, KorinoChikara, CanadianLinuxUser, Ka Faraq Gatri, Carcrash1106, MrOllie, SoSaysChappy, Glane23, Favonian, LinkFA-Bot, West.andrew.g, Lemonade100, 5 albert square, MattiPaavola, Tassedethe, Boovy1995, Dstingbaby, Iguana12345, Bossyza666, Unibond, Tide rolls, Lightbot, Sjeheiss, OIEnglish, Pietrow, Krano, Apteva, مازي, Gail, DK4, Legobot, Luckas-bot, Yobot, Zaereth, Liamiscool724, Mech Aaron, TaBOT-zerem, Legobot II, Taramoon, Jan Arkesteijn, MarkAlexan, Mmxx, Kingkarlos, Reinraum, South Bay, محبوب ع الم, Mdw0, AnomieBOT, KDS4444, Shauna32, Götz, Icysubdweller, Bsimmmons666, IRP, Galoubet, Piano non troppo, JdelaF, Sheen2112, Kingpin13, Teapot luke, Law, Ulric1313, Phoenix2210, Blueraspberry, B137, Giants27, Rtyq2, Citation bot, Hebrewgal21, Maxis ftw, Roux-HG, Frankenpuppy, Neurolysis, ShadowBlindx, Epicfail3, Xqbot, Sionus, Capricorn42, Drilnoth, Mize-nis123, Clausgroi, Armstrong1113149, Jeffmadethelightbulb, Acebulf, Collinswanson, Maddie!, Jnklolhaha, Cocobean76, Drafzilla, J04n, GrouchoBot, Spike105, Rareearther, DICEman988, Fgv505, Mhotep, RibotBOT, Hgn-p, Amaury, Peterdanielfazakas, Doulos Christos, Sheeson, Sewblon, Smallman12q, Junsun, Sesu Prime, Fotaun, Taka76, Jack B108, XatuGravelz, Nanya17, Xchapstique, FrescoBot, Mbennett555, Andrew-the-tortoise, LucienBOT, Paine Ellsworth, Coroboy, Toby72, Lucas1448, Bacinmaine, StaticVision, Asweno, Alkados, D'ohBot, Themaan25, Chris7061, Cutlerownsagain, Jersey99, HJ Mitchell, Strongbadmanofme, Jamesooders, A little insignificant, HamburgerRadio, Citation bot 1, Buzzingxx, Meow22322, AstaBOT15, Biker Biker, Pinethicket, Fraser360, Elockid, Adlerbot, Abductive, Jake9624, 10metreh, 09kjk!, Calmer Waters, Tinton5, Tomcat7, Lamber111, Jellydude, 9014user, Egrotatio, Xxxxxx65, Miguel Escopeta, Steve2011, DC, Abc518, Celebration81, FoxBot, Illegion, Banhtrung1, Comet Tuttle, Galaksedrengem, Mrn0lyf3r, Extra999, Begoon, Mrtaterhed, Coercorash, Robotimemory, GammaGT, NW512, Theonethatgotaway, Reidskin, Stev-o perrelli, Dark-wraith2012, Raye.tee, Suffusion of Yellow, Tbhotch, Reach Out to the Truth, Brambleclawx, MegaSloth, Wupsies, Northwestern guy, Thelardking, Ironkyd3395, Bbrusso15, Jakejb, Omkarkarom, RjwilmsiBot, Bokorember, Westpoint111, GangstaJoeTimBob, Jw079232,

Ipoopyouforyou, Gojoyoman3, Caster33, Teravolt, Mikelbikel124, Slon02, Bensheets1, LcawteHuggle, Petermcelwee, Deathbycoda, Whywhenwhohow, EmausBot, Energy Dome, John of Reading, Masiquer, WikitanvirBot, Sto4569, Pooky94, Immunize, Look2See1, Ajraddatz, Heracles31, Bradybunches, Dewritech, Arthur C. Miller, Jbxcolls, Student12, Minimac's Clone, Warthog102, Kb13579, Yay297, Freakinadrian, Tommy2010, Boogeyboogey, Madoo012, Lordchicken911, Rapple1997, Seikku Kaita, Zigaroo, Pogodog666, John Cline, 645984654654iutuyrftdry, TheFacts101, ASDFS, Yiosie2356, Elektrik Shoos, H3llBot, Wikfr, Errantchessman, RyanTaylor1987, Anonimski, Ipsign, ChuispastonBot, Hjb981, Jenova20, Justlettersandnumbers, BarrelProof, Frietjes, Corusant, DieSwartzPunkt, Kasirbot, Payerpal, MerllwBot, Helpful Pixie Bot, BatesIsBack, BG19bot, Kendall-K1, LFevas, Vanischenu, V4711, BattyBot, Jimw338, ChrisGualtieri, Layzeeboi, Dexbot, Rebakay, Spray787, SFK2, LPS.1, Camyoung54, LiveRail, Eric Corbett, Whizz40, ZDOCTOR, Monkbot, Missioner20 and Anonymous: 1662

- **Halogen lamp** *Source:* <http://en.wikipedia.org/wiki/Halogen%20lamp?oldid=657411167> *Contributors:* The Anome, SimonP, Andrewa, Glenn, Timwi, Radiojon, Rfc1394, BenFrantzDale, Ds13, AJim, AzaToth, Wtshymanski, Woohookitty, Mindmatrix, Benbest, MONGO, Zzyzx11, Rjwilmsi, Vegaswikian, Lmatt, WriterHound, Borgx, Kymacpherson, Groogle, Hydrargyrum, Anomalocaris, Danyoung, Voidxor, Richardcavell, Uwezi, Scheinwerfermann, Josh3580, Geoffrey.landis, SmackBot, Nicolas Barbier, Hydrogen Iodide, Marc Lacoste, Liaocyed, Modest Genius, Dogears, Lambiam, Peterlewis, CoolKoon, Muadd, Drlegendre, Van helsing, Rastusa, Cydebot, Kanags, Royzee, Rose Selavy, Electron9, Widefox, Edokter, JAnDbot, Jelloman, VoABot II, Frankk74, Kapunda, Canyouhearmentow, Vssun, DerHexer, I B Wright, Quickmythril, Acalamari, Tustiman, Squids and Chips, Idioma-bot, Funandtrvl, Fagioloner, Ziounclesi, Tri400, Andy Dingley, Monty845, PedroDaGr8, CMBJ, 156ableitem, SambaBij, ClueBot, JWilk, SecretDisc, Redcliffe92, Otolemur crassicaudatus, Kevinbushby, Pseudonym001, Muhandes, DumZiBot, Roxy the dog, Pero Despotovic, Avoided, SilvonenBot, Garycompugeek, Senachi, Ad-dbot, CanadianLinuxUser, Glane23, Jaydec, MattiPaavola, Tide rolls, Yobot, Specious, Reinraum, Supamichi, AnomieBOT, KDS4444, Jim1138, Commander Shepard, Kingpin13, LilHelpa, TheAMmolusc, Shilar, Medvedev, Rhinosaur022020, Jaxbo32, Pinethicket, MegaSloth, EmausBot, RA0808, Tommy2010, Erianna, Sahimrobot, L Kensington, Orange Suede Sofa, JonRichfield, Xanchester, ClueBot NG, Gareth Griffith-Jones, LightRobb, Widr, Snowgeek22, Helpful Pixie Bot, Jimcary05, Porfane, Kendall-K1, Mark Arsten, Boxofmatches, Midweststocks, Lemonnn, SteenthIwbot, Ugog Nizdast, Lucyloo10 and Anonymous: 138
- **Fused quartz** *Source:* <http://en.wikipedia.org/wiki/Fused%20quartz?oldid=654485592> *Contributors:* DrBob, Fred Bauder, Julesd, Bkell, Hadal, Syntax~enwiki, BenFrantzDale, AJim, Zeimusu, Yath, Deglr6328, Vsmith, ReallyNiceGuy, Femto, Tronno, Lysdexia, Gene Nygaard, Oleg Alexandrov, Yansa, Jacobolus, Polyparadigm, SDC, J S Lundeen, Goudzovski, Tardis, Srleffler, Jaraalbe, Debivort, YurikBot, Gardar Rurak, Hellbus, Psud, CambridgeBayWeather, Tony1, Vicarious, Sbyrnes321, SmackBot, Chych, Facial, Chris the speller, Bluebot, SauliH, Langbein Rise, Mpolianski~enwiki, Smokefoot, Jaganath, Kreuzfeld, BillFlis, Wizard191, Iridescent, JoeBot, Mfrosz, ChrisCork, W.F.Galway, Supremeknowledge, Playtime, George Reywer, Olegivvit~enwiki, Plantsurfer, Oskeew, Lawrie.skinner, ClubOranje, Leyo, Stan J Klimas, Afluegel, Pdcook, VolkovBot, NathanHagen, Drnathanfurious, Njn, Andy Dingley, Neparis, Martincc, Lightmouse, ClueBot, EoGuy, PixelBot, Boltonuv, Shinkolobwe, Bagunceiro, Plasmic Physics, XLinkBot, Hermanoere, Addbot, Freshground-coffee, WikiDreamer Bot, Zaeareth, Amirobot, Virtualjmillis, Materialschemist, Citation bot, Tescobar, Citation bot 1, Foges, RedBot, Johnheritage, RjwilmsiBot, Fusedsilica, Jackehammond, Mike Baumbach, Androstachys, EmausBot, Pahazzard, Mkratz, Erianna, Ulrich67, CaroleHenson, Johnwest1999, Helpful Pixie Bot, Th4n3r, ChrisGualtieri, LpLA123, Vanquisher.UA, Monkbot, Skipfortyfour and Anonymous: 71
- **LED lamp** *Source:* <http://en.wikipedia.org/wiki/LED%20lamp?oldid=661499567> *Contributors:* LA2, Julesd, Glenn, Bogdangiusca, Andres, Catskul, Gifltite, DocWatson42, Bfinn, Mcapdevila, Chobok, Dan aka jack, Beland, Djp~enwiki, JimWae, Heirpixel, Mike Rosoft, Wanted, Discospinster, Sergei Frolov, Bobo192, Nijelj, Conoino, Tritium6, Alansohn, StanZegel, Guy Harris, Atlant, Wexy, Rwendland, ProhibitOnions, Wtshymanski, Suruena, Grenavitar, Gene Nygaard, Yousaf465, Rintojiang, Mindmatrix, Guy M, Pol098, Tabletop, GregorB, SDC, VsevolodSipakov, Mandarax, BD2412, LanguageMan, Rjwilmsi, Hulagutten, Vegaswikian, Bubba73, SiriusB, Alex Sims, Riki, Lmatt, Srleffler, Qaanol, Youssefa, Gerfriedc, Arado, Brianpirie, GLaDOS, Jeh, Kelovy, Zzuuzz, Tabby, Arthur Rubin, Levil, CWenger, Geoffrey.landis, Groyolo, NetRoller 3D, Pragmatist, SmackBot, Unschool, Thorseth, Blue520, Thumperward, Oli Filth, Hibernian, VMS Mosaic, DinosaursLoveExistence, Lagrangian, IE, BrentRockwood, DMacks, Daniel.Cardenas, Mion, Bdushaw, Juux, Eliyak, Lester, Childzy, NJA, Sharcho, Ken McE, Hu12, Rogerfroud, Sameboat, CuriousEric, N2e, Erencexor, Matthew Treder, Slazenger, Cydebot, Gogo Dodo, Ozgyu89, Dtgricom, Electron9, Mattfiller, Amrush, Dawnseeker2000, Rees11, Gioto, Widefox, Seaphoto, SummerPhD, AnAj, LegitimateAndEvenCompelling, Barek, MER-C, Arch dude, Edehaan, Ccrrccrr, Denimadept, SiobhanHansa, Acroterion, VKing, Schily, Cpl Syx, NJR ZA, Cander0000, WLU, Custardninja, Mattjs, R'n'B, Dalekmeat, EdBever, Advaidb, Snowfalcon cu, All Is One, Jesant13, Professor Magneto, Gypsydoctor, AntiSpamBot, Warut, Totsugeki, Idioma-bot, Signalhead, Vranak, VolkovBot, EEye, Slaunger, Gideonr0, Razvan NEAGOE, Mazarin07, Emma Ephemera, Falcon8765, Greentopia, Spikybeagle, Gamefreak2413, Ceranthor, PokeYourHeadOff, SieBot, Prcr, Euryalus, Rudhar, Dawn Bard, StaceyGrove, Grundle2600, Jerryobject, CJaguar265, Dwane E Anderson, Cgaze22, Theaveng, Oda Mari, Jojalozzo, Nopetro, Istaro, Lightmouse, User5910, LEDtronics, KathrynLybarger, Diamond Electronics, CLiMber00, Dabomb87, Dlrrohrer2003, Atif.t2, ClueBot, Intllighttech, LP-mn, Cambrasa, Drmies, Uncle Milty, Polymorph, Bobbyang808, Rockfang, Zoldan84, Srjsignal, Robert Skyhawk, G7vvg, Zeromind, Imanferrari, Fredquint, SchreiberBike, Redmanb11, Inspiron43, Versus22, TroyBaker, JosephReis, BurgererSF~enwiki, BlackEvil, Mavigogun, Jgamleus, Facts707, Xmitman, Cluginbuhl, Addbot, JB-supreme, Mortense, Cantaloupe2, Ka Faraq Gatri, Palomar-wp, H92Bot, CUSENZA Mario, Successed, Splodgeness, Azul007, Tide rolls, Pietrow, Jeffdotchan, مازني, Wireless friend, Twimoki, Ettrig, Lucas-bot, Ash108, WikiDan61, Themfromspace, Grebaldar, Weathene, AnomieBOT, KDS4444, Jim1138, Galoubet, Sap123, Aaagmnr, Materialschemist, Citation bot, LilHelpa, Ched, GreenEconomy, Jliowa, Johnkoger, Ledlight, Quincyplus, Henk.muller, Gnelhans, Shadowjams, Prari, FrescoBot, Recognizance, HJ Mitchell, Ánforas, Citation bot 1, Pinethicket, The Arbiter, Doctor567, Dh9, Marcopete87, Andrewsamuels1988, Jackson chack, Perpetuum1, RjwilmsiBot, EmausBot, Seamos, Diamondpeter, Lucien504, Dewritech, GoingBatty, Harvardton, RA0808, Vignanisolutions, Ledlighting922, K6ka, Richardop3, Joe Jenze, AzuaHart, Mkratz, Jbird82158, Wowformore, Westpeter, Oldfox2003, Chanjunsung, Erianna, Bmauriello, Gsarwa, Suraj88, Fanyavizuri, LightingLeader, Deanernst, Ipsign, Rangoon11, Vikassvc, Angerdan, TheLEDMan, Gmt2001, ClueBot NG, Mbrock1969, BarrelProof, Khuzaima 9, Venson2, Concord113, DieSwartzPunkt, Blueviper99, Mtking, MerllwBot, Helpful Pixie Bot, Ledtbar, Mar-clLEDLtd, RembrandtWrites, TennTwister, BG19bot, Lora.luyu, Oxydendrum, Saurav121290, Johnpaul891, Los300espartacos, Qclove, Ramiro Polla, Sparkie82, Snow Blizzard, Zedshort, Verbcatcher, Tradesteady, BattyBot, Agentspamstastic, Rogerdow, ChrisGualtieri, Joshknoedler, Lunashy, EagerToddler39, BrightStarSky, Cledlight, Dexbot, Дневной дозор, Jamesx12345, Mark viking, Anne6766779858, Livin Large VT, Hemworld11, Hartesolos00, Stevenrodrig, R0stam, Crontab1, Shane5476, Bright Choice Lighting, Light Evolution, LucySofia, Wyn.junior, Lagoset, Sphoieemma, Riddleh, Monkbot, Taksony1986, BethNaught, Hai409, JohnC51986, Jacobwatts2001, Thachhoang56, Spencerwait, Raytraser, Charleybell, StanfordLinkBot, Alex2151987 and Anonymous: 323
- **Light-emitting diode** *Source:* <http://en.wikipedia.org/wiki/Light-emitting%20diode?oldid=662172546> *Contributors:* Bryan Derksen, Tarquin, Taw, Dragon Dave, Css, Dachshund, Rmhermen, Christian List, Aldie, DrBob, Heron, Ewen, Rickyrab, Octothorn, Edward, Patrick, Michael Hardy, JakeVortex, (, lluvcapra, Rethunk, SebastianHelm, Spliced, Ahoerstemeier, Mac, Baylink, G-Man, Mangrel,

Julesd, Goblin, Glenn, Nikai, Andres, Rob Hooft, Feedmecereal, Tantalate, Timwi, Jdstroy, David Newton, Dcoetzee, Bemoeial, Wikiborg, RickK, Reddi, Andrewman327, Evgeni Sergeev, Zoicon5, Radiojon, Maximus Rex, Imc, Furrykef, Nv8200pa, Carol Fenijn, EthanL, Omegatron, Ed g2s, Rnbc, Wernher, Finlay McWalter, JorgeGG, Phil Boswell, Rogger-enwiki, Robbot, Hankwang, Fredrik, RedWolf, Rholton, Rursus, KellyCoinGuy, Hadal, HaeB, MikeCapone, Carnildo, Ancheta Wis, Tosha, Giftlite, Bob Burton, Nroose, DocWatson42, DavidCary, Inter, InKling, Himbeerkuichen, Timpo, Wwoods, Everykyng, Jonabbey, Michael Devore, Abqwildcat, Leonard G., AJim, Mboverload, Stuuf, Rchandra, FooBar, DÅ,ugosz, Glengarry, Ragib, Vadmium, Chowbok, Gadfium, Utcursch, ConradPino, Antandrus, Beland, Ctachme, Eregli bob, MacGyverMagic, DragonflySixtyseven, Gene s, Icairns, Iantresman, Mschindwein, Sonett72, BrianWilloughby, Deglr6328, Qdr, Jimaginator, Mike Rosoft, Chris Howard, Rfl, Imroy, Chris j wood, Discospinster, Rich Farmbrough, Guanabot, Lovelac7, Sladen, TomPreuss, Andros 1337, Florian Blaschke, Adam850, Xezbeth, Paul August, Sergei Frolov, Kenb215, Bender235, Loren36, Plugwash, Aqua008, Torindkftl, Kwamikagami, Tom, Spearhead, Sietse Snel, Aaronbrick, Femto, Perfecto, Causa sui, Bobo192, Nigelj, O18, Flxmghvgvk, Savvo, Dungodung, Slicky, Timpl, Giraffedata, Sasquatch, PiccoloNamek, Pschemp, Zetawoof, Helix84, SPUI, Hooperbloob, QuantumEleven, Stephen Bain, Lysdexia, Nashikawa, Espoo, Jumbuck, Zachlipton, Wendell, Chino, Jared81, Eric Kvaalen, Atlant, Andrewpmk, CaptHayfever, AzaToth, Water Bottle, Theodore Kloba, TVSRR, VladimirKorablin, Rpellessier, Samohyl Jan, Wtmitchell, Bucephalus, BRW, Wtshymanski, Stephan Leeds, Andrew Taylor, Cal 1234, Harej, LFaraone, H2g2bob, Skatebiker, Seifaerastlinlp2, Gene Nygaard, Mattbrundage, HGB, Kay Dekker, Phi beta, Kenyon, Dismas, Yousaf465, Daranz, Demiurg, Bobrayner, Distantbody, Rintojiang, Mindmatrix, Camw, LOL, Miaow Miaow, Davidkazuhiro, Jeff3000, GalFisk, GregorB, Eaolson, Isnow, SDC, Pasteler0, Dequinix, Mandarax, Graham87, Nanite, EdDavies, Susten.biz, Drbogdan, Saperaud-enwiki, Rjwilmsi, Tizio, Scandum, Virtualphtn, Wikibofh, Tangotango, Vegaswikian, Dmccreary, SanGatiche, Yamamoto Ichiro, Ghalas, SNIyer12, Titoxd, FlaBot, Pilchard, Arnero, Winhunter, Nihiltres, Gary Cziko, Isotope23, RexNL, Jrtayloriv, Gussisaurio, Rob*, Lmatt, Fct, Goudzovski, Srleffler, Comiscuous, Imnotminkus, Tene, Jaraalbe, DVdm, Bgwhite, Eric B, Siddhant, YurikBot, Wavelength, Oliviosu-enwiki, Sceptre, Wester, Huw Powell, Jimp, Adam1213, MMuzammils, Prometheus235, DMahalko, Bhny, Tyler.szabo, JabberWok, Rada, Fabricationary, Hellbus, RadioFan, Hydrargyrum, KevinCuddeback, Cate, Gaius Cornelius, Shaddack, Neilbeach, Kimchi.sg, Bisqwit, Paperless-enwiki, Marcus Cyron, David R. Ingham, EngineerScotty, NawlinWiki, Liastnir, Janke, Thiseye, Nick, Goffrie, Prod, Bobak, Vatassery, RUL3R, Furtim, Voidxor, Alex43223, Ajmoonz1, Vw12, Dbfirs, SFC9394, Gadget850, Schnob Reider, Jeh, Wolfling, Kkmurray, Mike92591, Searchme, Wchan07, Orioane, Morcheeba, Fernis27, Tabby, Pb30, Abune, CharlesHBennett, StealthFox, GraemeL, Glabrata, JoanneB, Red Jay, Vicarious, Chriswaterguy, Luiscolorado, Shyam, Back ache, ArielGold, AGToth, Yonir, JDSpeeder1, Groyolo, Jimerb, LED King, Eigenlambda, SmackBot, Brian Patrie, Erwinrossen, TestPilot, Pavlovič, C.Fred, Thorseth, Blue520, The Photon, Davewild, Video99, Anastrophe, Ace of Risk, Brossow, AnOddName, Edgar181, Cool3, Gilliam, Ohnoitsjamie, Subhan M Ali, Martial Law, Deloreanman14, Vercalos, Lindosland, Schmiteye, Chris the speller, Bluebot, Trebor, Persian Poet Gal, Oli Filth, Pylori, Jeysaba, Kunalmehta, MalafayaBot, Fluri, Papa November, Ihoudini, Samanathon, EdgeOfEpsilon, DHN-bot-enwiki, Smcnair, Darth Panda, A. B., Hgrosner, Audriusa, Bsilverthorn, Simpsons contributor, Chendy, Dethme0w, Can't sleep, clown will eat me, SiriusAlphaCMA, Shalom Yechiel, Zava, Frap, DB5, Onorem, Rw, PyroTom, VMS Mosaic, DGerman, MrRadioGuy, Robma, Master Scott Hall, Makemi, Teehee123, AdeMiami, RandomP, ShaunES, Drphilharmonic, DMacks, Wizardman, Zzorse, Bdiscoe, Where, Luigi.a.cruz, Daniel.Cardenas, Mion, Vina-iwbot-enwiki, Dogears, Juux, John Reid, Autopilot, The undertow, SpareHeadOne, Alexander256, Esrever, Lester, Gloriamarie, Vanished user 9139j3, DireWolf-enwiki, Khazar, Bando26, Gobonobo, Lue3378, Titaniumcranium, LoonyLuke, Joffeloff, Noahspurrier, Aleefn1, Tiki God, Avé, PseudoSudo, Ckatz, Bagelboy2020, CyrilB, A. Parrot, Volkan Yuksel, Loadmaster, JHunterJ, Grapetonix, Stwalkerster, Beetstra, Dkeane86, Dicklyon, Spiel496, TimTL, Kvng, Hu12, Quaeler, Stiofan.walsh, Bennyboy80, Iridescent, Denis1210-enwiki, Lathrop1885, Courcelles, Gavintlgold-enwiki, Achoo5000, Chetvorno, Elekas, Cm the p, MightyWarrior, SkyWalker, Thermos-enwiki, Sakurambo, Thatperson, CmdrObot, Tarchon, David s graff, Shyland, Van helsing, Balazer, Ilikefood, Rawling, Deepshark5, Radihh, Leevanjackson, GHe, Jsmaye, Xakuzzah, Inzy, Slade24, Syoo-enwiki, Besieged, Kaldosh, Gogo Dodo, CorpX, Dr.enh, Codetiger, DumbBOT, Saminshams, Teratornis, Jmasalle, Biblbroks, Mitjaprelvsek-enwiki, Ferris37, Editor at Large, Mtpaley, Mailerdaemon, Mattisje, Eprb123, Jopo, R Landgren, Alexofdodd, Keraunos, N5iln, Mojo Hand, Dtgrissom, Marek69, Smile a While, Electron9, James086, Hulmey, Leon7, Mlogic, Dawnsseeker2000, Eiffelle, Duncan Jaques, Jtmooon, AntiVandalBot, Xpertlong, Widefox, QuiteUnusual, SummerPhD, Shirt58, MontanNito, Tneedham, Kristoferb, Brian Katt, Megalaser, Blair Bonnett, David Shankbone, LegitimateAndEvenCompelling, Cbrodersen, Rcombe, Signaltech, Michael.j.sykora, JAnDbot, Defective, Ncmattj, MER-C, CosineKitty, Ericoides, Instinct, Arch dude, Majestique, Albany NY, Cerrccrr, Andonic, Saritamackita, Yanngeffrotin-enwiki, MSBOT, Easchiff, Penubag, Magioladitis, Legallydolls, Bongwarrior, VoABot II, Spuggie, JamesBWatson, Brusegadi, CosmicPenguin, Catgut, ML1986, Efansay, CodeCat, LorenzoB, Adkoon, User A1, Cpl Syx, DerHexer, JaGa, Philg88, Edward321, Colithium, Khalid Mahmood, Amolkumar, WLU, ForestJay, I B Wright, Chuckwatson, Custardninja, Atlfalcons866, Hdt83, MartinBot, DelCavallo, Ariel., Jim.henderson, Sm8900, Greg0658, Sabbathcrazy, Kostisl, Mbrstooge, Mycroft7, CommonsDelinker, Nono64, Ctroy36, Tgeairn, RockMFR, Arriva436, Eybot-enwiki, Watch37264, J.delanoy, Pharaoh of the Wizards, Trusilver, Clock twibright, Noitsnot, All Is One, Jesant13, Thepaan, Gate-way, Peleides, Rubenyi, DigitalCatalyst, NYCROSS, Bluesquareapple, Fishyghost, Troglodytes-enwiki, Gzkn, McDScott, Michael Daly, Dispenser, Eric Mathews Technology, McSly, BaseballDetective, Jeepday, Mentalmouse, Chris Lewins, Spartelite, DadaNeem, Gregfitzy, Vanished user 47736712, Stev88, Anatoly larkin, Lilwik, Antipoff, Dhaluza, Joshua Issac, Cometstyles, Remember the dot, GCFreak2, Magatouche, TWC Carlson, Alan012, H1voltage, S, Billjoie, Reelrt, Signalhead, Deor, VolkovBot, EEye, ABF, Lynchmob98, RomboMax, Jeff G., James Callahan, Dqeswn, Rozzin, Tobymyasaunders, USALEDS, Davidwr, Aesopos, Dbooksta, Lingwitt, Charleca, DoorsAjar, Miwaya, Geoffling, Hempdiddy, Grodvin, Americhinab2b, Kritikos99, Blue-led-GaN, Rei-bot, Wikidemon, Dictouray, Pearsallt, AllGloryToTheHypnotoad, Morkromy, Raymond-winn, Razvan NEAGOE, DesmondW, LegendLength, Autodidactyl, Firedup52, Wingedsubmariner, Inductiveload, Madhero88, Ebulides, Andy Dingley, Jamiehandler, Jerry guru, CryptWizard, Vchimpanzee, Alokpsah, Mahira75249, Riversong, Ekao1111, Truthanado, HerschelPeeler, Readpedia, JWhiteheadcc, AlleborgoBot, Thunderbird2, KarusaUK, SvNH, The Realms of Gold, EmxBot, Hans-wai, Yngvarr, SieBot, Drewhamilton, Mikemoral, Hrf, Andrarais, Caudle, Cyril.holweck, Lemonflash, Winchelsea, The Parsnip!, Bhimaji, Calabraxthis, StaceyGrove, Freddyzdead, GlassCobra, Jerryobject, Spencerhudson, Happysailor, Flyer22, Radon210, Oysterguitarist, Debussy Aguter, Permacultura, Jojalozzo, Nopetro, OsamaBinLogin, Rob.ashwell, KoshVorlon, RW Marloe, LEDtronics, Glasscranium, Alex.muller, RiseDarthVader, Nancy, MalinDixon, The Stickler, StaticGull, Adi necromancer, Eeppelelopeo, Lozer face, WikiLaurent, Denisarona, C0nanPayne, Aadgray, ImageRemovalBot, Nedvedfan11, Dlrhorer2003, Atg-electronics, Atif.t2, Seanbyr, Meatspinsryummy, Martarius, Sfan00 IMG, Rhyshuw1-enwiki, ClueBot, Binksternet, GorillaWarfare, Jon pheasant, Allwin21, EoGuy, Noblevmy, ImperfectlyInformed, Ark2120, Manutdglory, Mx3, Wanderer57, Niyants, Arakunem, Y4m4h4, Wispanow, Mild Bill Hiccup, Shadowex132, Mr sean meers1, Dave r jenkins, CounterVandalismBot, Grey noise, Gregr888, Eric.brasseur, Hschlarb, Loriele-enwiki, Namazu-tron, Pointillist, Gordon Ecker, DragonBot, Craigibc, No such user, Excirial, Jusdafax, SunNet, Old good days...., Eeekster, G7vvg, Mwasheim, Zaharous, Bvg111, Tailoredvagabond, A3camero, Jotterbot, LarryMorseDCOhio, Eitheta, Buck1470, QASIMARA, Thhhh, Montsnmags, Amolhshah, Nhyty, Subash.chandran007, Versus22, SoxBot III, HumphreyW, DumZiBot, Steveozone, Ayjazz, TNTM64, XLinkBot, Shpakovich, Spifire, Stickee, SJ Morg, LaurenHeist, Ost316, Ivanmoreno, Nepenthes, Avoided, Time Guy, Doc9871, Alexius08, Kaiwhakahaere, WikiDao, Kpmkpm, Dnrvfantj, Addbot, Jfiala, AVand, Base369, Giftiger wunsch, DOI bot, Fryael, Betterusername, Contract-Lighting-Designer,

Edgy01, Imarzouka, Sammybz, Meuzzwal, Jim10701, MrOllie, Download, Belmond, Squirrel9000, Ptc10, Glane23, Bagelverse, Favonian, Kayled, Laputa97, David451, CuteHappyBrute, Tassedethe, Azul007, Tide rolls, Lightbot, Sleepygonzales, Apteve, Teles, Greyhood, SmolderinCorpse, Nwimpney, Swarm, Oaooaoo, Legobot, Middayeexpress, PlankBot, Luckas-bot, Nunikasi, Yobot, WikiDan61, Themfromspace, Cfm001, TomTrottier, Patriick, Nallimbot, KamikazeBot, Newwikiprofile001, AnakngAraw, Banjohunter, Andvd, Dillanvaghela, AnomieBOT, KDS4444, DemocraticLuntz, Rubinbot, Jim1138, Hkeaton, 9258fahsfkh917fas, Mintrick, Piano non troppo, Flurrysome, Kingpin13, Dinesh smita, Jo3sampl, EryZ, Plan9FOS, Flewis, Powerzilla, MaterialsScientist, Groundhogwilberwiever, Citation bot, Astor14, Akilaa, Packexe, Alkhowarizmi, Brightgalrs, RevelationDirect, Carlsotr, MatthewHarbor, GB fan, Neurolysis, LilHelpa, Ethan1415, Xqbot, Mikes1807, Capricorn42, Alfred1520, Tomdo08, Adadurov A, Ched, Star Trek enthusiast, Bino2uuz, GrouchoBot, Abce2, Geecess, Twirligig, KeLopez CL, Omnipaedista, Mathonius, Nedim Ardoğa, JoanneRSC, Locobot, Rgategch, WikiEditorContributor, Schmonyon, MrTennis, N419BH, Krrish23, Jwcknet, Theeditor4ever, Lelapindore, Shadowjams, WaysToEscape, Madison Alex, Gnuish, C7mb, A. di M., BoomerAB, Heldenbergledshift, Robynthehode, Vanni.T, Prari, Krinkle, Bobtompson, FrescoBot, Patrickwilliams31, Pepper, Nageh, DennisK33, Abbedabb, Philebritite, Oldlaptop321, VS6507, Recognizance, Wuby25, Uglyzebras, Weetoddid, NaturalKnowledge, Finalius, Jamesooders, Sync755, SeanBond, Arrson.led, Citation bot 1, ك م ع ل, Pinethicket, 10metreh, Calmer Waters, Cmoore1414, Thinkspank101, JoeliusCeasar, Squallyz, Chris56000, Just4lulz, Lissajous, Merlion444, Rhyslist, Hardwigge, Spidey71, Elekhh, Tucvbif, Trappist the monk, Mgai7755, Yunshui, Lotje, MrX, Brodie 145, RPinney331, JenniferSimmons, Reaper Eternal, Saru786, Merlinsorca, Bluebell79, Unbitwise, Minimac, Guangzhou0587, Mean as custard, RjwilmsiBot, Hardikvasa, Hugomoto, Woolly wombat, Phlegat, Carolynlowe, Teravolt, WikiEditor2222, WildBot, DASHBot, EmausBot, John of Reading, NoIanyoneknows, WikitanvirBot, Krabs456, Niuhaibiao, Sherazade96, Harvardton, RA0808, Wiki-asd-97, Bobkart, TuHan-Bot, Richardop3, Auró, FunkyCanute, Chris.felipe.ordonez, ManosHacker, Shuipz3, Ziyunlong, Lindseyrose, The Nut, KuduIO, HyperSonic X, Bamyers99, H3llBot, Lkingscott, L0ngpar1sh, Armyxi, Tenter5, Sbmeirow, EdwinAmi, Tdogilyv, Brandmeister, Bmauriello, L Kensington, Wharboy79, Gsarwa, Donner60, Sslsefrc, Kobbra, Orange Suede Sofa, Toomuchrockcankill, Bomazi, Cnsureleds, Andrestebro, Zvp633, Камалһһ001, Rf72, Ledshov, Angerdan, Seryddwr, Mikhail Ryazanov, Alphabet27, ClueBot NG, Gareth Griffith-Jones, JetBlast, Matthiaspaul, MelbourneStar, Anbnkaga, LogX, Fauzan, Stevenlead, AeroPsico, Wdchk, ConconJondor, Hindustanilanguage, Frietjes, DieSwartzPunkt, Axvin, Ledsoft, Lefty95, Escapepea, Lolpotato123, Widr, ځړوځو, JoePickford, Mrgardnerisakinkytwat, Helpful Pixie Bot, Truemar, Wombatmatty, Strike Eagle, Illuminatethedark, JohnOFL, RembrandtWrites, Bibcode Bot, Carolyn Technology Business, Ecoxotic, BG19bot, Docvegetal, PortlandArchitect, Saurav121290, MusikAnimal, MaYoulu, Johnpaul891, Rituraj.shukla, Floating Boat, Nuke1st, Xinda2000, Ulidtko, Glacialfox, 220 of Borg, Achowat, BillBucket, Smarandi, Venkateshd27, BattyBot, Tfchew, Seanbigz0300, Jimw338, Bright2, ChrisGualtieri, EdWitt, Joshknoedler, Markshark98, Ajv39, Benny3t3, EagerToddler39, BrightStarSky, Diguoliangmin, Alberta, Mogism, JZNIOSH, Blueghost0221, Andrewmartindodson, Jprovenst, Ash kartik, Beckaroon, Lugia2453, BeaumontTaz, SFK2, UNOwenNYC, Jamesx12345, Tyleerr, Vahid alpha, Understated123, Pincrete, ArcticSilver, Faizan, MWikiOrg, G PViB, Hamza2001, Lumiaire, FunnyPika, Simon Shahin, Metalomer, QURATULAIN PAK, Gemaayan97, Buntybhai, Ashishbuntybhaya, Lianxi5968, Sunway212, Ginsulofit, Crontab1, Abcd1234567, Wikifan2744, Gymnstx64, User238345, Ermenda123, JaconaFrere, LucySofia, NV302EE, Wyn.junior, Monkbot, Geoff Koch PDX, Bandenled, DaveeBlahBlah, Basilshmm, Ledwalker, AmericanSocialist, Simoncoombes, TerryAlex, LOJack-Daniel, Lightledwork, Jacobwatts2001, KathyHacks, Ghiridhar Sriganesan, Tigbits, ArmishTechSupport, Siddharth.saxena25, Khuedhsp, Haydeypoos, Samalmaairgy, Kiwi2002, Tetra quark, Vantait, Connor freeman, Sahan.v.ranasinghe, Sigma alpha gamma, KasparBot, Shreyashrd, Akash rocket5 and Anonymous: 1690

- Arc lamp** *Source:* <http://en.wikipedia.org/wiki/Arc%20lamp?oldid=658866933> *Contributors:* Dachshund, Ahoerstemeier, Glenn, Bemoeial, Reddi, Tpradbury, Rnbc, Topbanana, Raul654, Jerzy, Qertis, Wikibot, Leonard G., FooBAR, Gadium, Geni, Icairns, Night Gyr, CanisRufus, Jumbuck, Atlant, PAR, Wtshymanski, DV8 2XL, Kelly Martin, Julio, SDC, Rjwilmsi, Yamamoto Chiro, Old Moonraker, Arnero, Gurch, Lmatt, Srleffler, DVdm, Hairy Dude, Pburka, KamuiShirou, Bhny, Shaddack, DragonHawk, Welsh, BOT-Superzerocool, Bota47, Tabby, RedJ 17, SmackBot, FocalPoint, Herostratus, Melchoir, Edgar181, Zephyris, MrRadioGuy, Joe C, Bejnar, Dogears, PRRfan, DagErlingSmørgrav, Simonpage, Scarlet Lioness, Chetvorno, Mapsax, Mikiemike, Ninetyone, Nczempin, Constructive, Z10x, Bigsus, Vikedal, JAnDbot, Kuyabribri, Sith Lord 13, Saschathegerman, LorenzoB, Vssun, Zahakiel, Glrx, CommonsDelinker, Braeig15, Dawright12, Keizers, Sam Paris, Wa3pxx, D-Kuru, Idioma-bot, WilliamSommerwerck, Hrothberht, CanOfWorms, Raymondwinn, Korin43, SieBot, Steve19steve, Martarius, ClueBot, Sabbe, Kafka Liz, ZngZng-enwiki, Uncle Milty, Hackattack31, Alexbot, Tuzi, Ing, Rudolf Wandl, Addbot, K Eliza Coyne, JGKlein, Lightbot, Luckas-bot, Yobot, Zaereth, Ciphers, Citation bot, Jagcat98, DSisyphBot, Fotaun, Alarics, Norman6874, DrilBot, Rudythecutie, Tom.Reding, Trappist the monk, ڊال بيا, Wikipelli, Ebrambot, ClueBot NG, Helpful Pixie Bot, BG19bot, Tom Pippens, CitationCleanerBot, Mr.garbage, Tommy Pinball, Infocompost, Ice823cream, Monkbot, Hoggsbison47, Krelcoyne, Bdaustin123 and Anonymous: 59
- Xenon arc lamp** *Source:* <http://en.wikipedia.org/wiki/Xenon%20arc%20lamp?oldid=648087084> *Contributors:* Bryan Derksen, Leandro, Ixfd64, Ahoerstemeier, Julesd, Glenn, Andres, Jleedev, AJim, Rchandra, Bobblewik, DmitryKo, Vsmith, Alistair1978, Bobo192, Timl, Hooperbloob, Atlant, Dennis, Chburnett, RJFJR, Gene Nygaard, Bratsche, SDC, Magister Mathematicae, John Nixon, Arnero, Lmatt, Srl-effler, Hydrargyrum, Gaius Cornelius, Alynna Kasmira, David R. Ingham, Formina Sage, Max-G-enwiki, BeastRHIT, Kkmurray, Uwezi, Scheinwerfermann, BorgQueen, SmackBot, Army, Edgar181, Jupix, Chris the speller, Hgrosser, Audriusa, Fuhgettaboutit, Pwjb, 4hodmt, DMacks, TheBoDe, Dogears, John, Nfutvol, Scarlet Lioness, Nmadhubala, Chetvorno, Hyperlight, Quaxmonster, Brinnington, Headbomb, X201, Ekashp, Rotareneg, WinBot, JAnDbot, Dulciana, LorenzoB, JohnEklund, Danielmiester, Totsugeki, D-Kuru, Onkelringelhuth, Idioma-bot, Joeinwap, Chromancer, Aucitypops, Al.locke, Su37amelia, Jhawkinson, Truthanado, Krzysoo-enwiki, Avenged Eightfold, Arakunem, Sun Creator, DumZiBoT, Addbot, Poco a poco, Cantaloupe2, LaaknorBot, Vercingeterix, Peti610botH, NapoleonoftheNow, Luckas-bot, Zaereth, Fox89, AnomieBOT, Anon423, FrescoBot, Oxyzal, Rakash628, RedBot, DASHBot, Johnwagaman, ClueBot NG, Jexcelias, Helpful Pixie Bot, Sobarwiki, BattyBot, Mogism, Vosseletronic and Anonymous: 64
- Ultra-high-performance lamp** *Source:* <http://en.wikipedia.org/wiki/Ultra-high-performance%20lamp?oldid=659794740> *Contributors:* Glenn, Ciampix, Beland, DmitryKo, Rich Farmbrough, Tphanich, RussBot, SmackBot, Senatorpj, Pwjb, Dicklyon, ShakingSpirit, Gul88gul, FF7Sephithro, Guy0307, Magioladitis, Mkdw, R'n'B, Squids and Chips, Dburner, Addbot, DOI bot, Tom.Reding, SteveGreg, Iamdjohn and Anonymous: 19
- Metal-halide lamp** *Source:* <http://en.wikipedia.org/wiki/Metal-halide%20lamp?oldid=652692470> *Contributors:* Edward, Glenn, Andres, Smack, Henrygb, Pengo, Mintleaf-enwiki, Mako098765, DmitryKo, Discospinster, Trelligan, Kwamikagami, Bobo192, WideArc, Atlant, Ricky81682, PAR, Wtshymanski, Skatebiker, Gene Nygaard, Kazvorpal, Mindmatrix, SDC, Nthdegx, Mandarax, Erebus555, Ceinturion, John Nixon, Old Moonraker, Lmatt, Srleffler, Radishes, DMahalko, Chris Murphy, Gerben49-enwiki, Kniveswood, Kf4bdy, That Guy, From That Show!, SmackBot, Bogdantudor, Martylunford, Edgar181, Cool3, Pzavon, Bluebot, Zkar, Jerome Charles Potts, Rrburke, Waran777, Jmak, Khazar, BDM, Beetstra, Vwozone, Ginkgo100, CzarB, Enginear, Chetvorno, JForget, Sakurambo, Mg rotc2487, The real dan, Ozguy89, Thijs!bot, IvanStepaniuk, Brinnington, Mixsynth, Dawnseeker2000, Jay0013, Chondrite, Rich257, Nikevich, JoeX-enwiki, DGG, R'n'B, CommonsDelinker, M-le-mot-dit, DeFaultRyan, TWC Carlson, Macfanatic, Cloudswrest, Rumiton, Buffs, Geepster, Sambal

- Bij, Francvs, Mrjkb, Mild Bill Hiccup, Twostaricebox, TJFox, DumZiBoT, SilvonenBot, Xmitman, Nikhilb239, Addbot, Cantaloupe2, Queenmomcat, Ronhjones, TutterMouse, SpBot, Pince Nez, Waidesworld, Luckas-bot, Yobot, AnomieBOT, KDS4444, Citation bot, Powderbear, Xqbot, GrouchoBot, Chongkian, Globe Collector, Jfultz, Drunauthorized, Tinton5, MastiBot, Marcopete87, SkyMachine, Tim1357, A7N8X, HybridK9, Rāmā, دالبا, EmausBot, John of Reading, WolfnArmour, RenamedUser01302013, LMRoberts, Spicemix, Yamagawa10k, ClueBot NG, Helpful Pixie Bot, Voltron61, BG19bot, PhnomPencil, GRights, Qxukhgiels, Tom Appel, Monkbot and Anonymus: 118
- Gas-discharge lamp** *Source:* <http://en.wikipedia.org/wiki/Gas-discharge%20lamp?oldid=647859166> *Contributors:* Glenn, Radiojon, Finlay McWalter, Donarreiskoffer, Robbot, Leonard G., Icairns, Deglr6328, DmitryKo, Cedders, Bert Hickman, Nk, Hooperbloom, Alansohn, Atlant, Wtshymanski, Gene Nygaard, Woohookitty, Pol098, Timrichardson, SDC, Pfunk42, Edison, Lmatt, Srfleffer, Chobot, YurikBot, Pburka, Gaius Cornelius, Welsh, Gerben49-enwiki, Bota47, Crisco 1492, Scheinwerfermann, Geoffrey.landis, That Guy, From That Show!, Herostratus, Pedrose, VIadislav, VMS Mosaic, NickPenguin, RomanSpa, NJA, Iridescent, Engineer, Chetvorno, Raz1el, WeggeBot, Slazenger, Riflemans 82, Dawnseeker2000, Herald Alberich, JAnDbot, Naval Scene, Grimlock, HuntClubJoe, Nono64, Acalamari, LordAnubisBOT, ARTE, VolkovBot, TXiKiBoT, Typ932, Inusuh, Cwkmil, Steve19steve, WikiLaurent, ClueBot, DragonBot, PixelBot, Winston365, Ovesen, HexaChord, Addbot, Sun Ladder, Alchemist-hp, Margin1522, Zaereth, DemocraticLuntz, MaterialsScientist, Erud, Fotaun, LucienBOT, JuniperisCommunis, OGREBot, Edisonorellana12, Stefan Weil, Tom.Reding, RaySys, Symppis, 777sms, Jynto, Pinnygold, دالبا, ArwinJ, Teravolt, EmausBot, Kingtech Auto Parts, RaptureBot, Yamagawa10k, Mikhail Ryazanov, ClueBot NG, Gareth Griffith-Jones, 336, Reify-tech, Boris3233, CeraBot, Abilani, Qxukhgiels, GypsyEyes, Straje, Fall's Cumuli, Apon1 and Anonymus: 51
 - Fluorescent lamp** *Source:* <http://en.wikipedia.org/wiki/Fluorescent%20lamp?oldid=661732554> *Contributors:* AxelBoldt, Bryan Derksen, Malcolm Farmer, Rjstott, Lorax, Codeczero, Ray Van De Walker, Heron, Hephaestos, Frecklefoot, Edward, RTC, Delirium, Kosebame, Ahoerstemeier, Ronz, Kragen, Glenn, Andres, Glueball, Smack, Tobyvoss, Mulad, Ec5618, Bemoeial, Reddi, Stone, Radiojon, Laussy, Maximus Rex, Taxman, Omegatron, David.Monniaux, Jeffq, Donarreiskoffer, Robbot, Ke4roh, Hankwang, Chealer, Chris 73, RedWolf, Academic Challenger, Sndrsn, Bkell, EvilPettingZoo, Jpo, Gwalla, DocWatson42, MPF, DavidCary, Art Carlson, Brona, Archenzo, Boblewik, Edcolins, Neile, Vadmium, Chowbok, Gadfiun, Andycj, Dan aka jack, H Padleckas, Icairns, Blue387, Iantresman, WpZurp, Kevin Rector, Deglr6328, Inkwina, QuiLche, Mormegil, JTN, Discospinster, Shinglor, YUL89YYZ, Bender235, Jaberwocky6669, Kbh3rd, Mattdm, Mcpusc, MBisanz, Wfisher, Evand, Dennis Brown, The Noodle Incident, West London Dweller, Bobo192, Snozberry, Meggar, BrokenSegue, Rmv, Ygfperson, Joe Jarvis, Jhd, WideArc, Alansohn, Mgevad, Guy Harris, Atlant, Keenan Pepper, Andrew Gray, Sade, Nasukaren, Stevestrange, Stillnotelf, Miltonhowe, Wtshymanski, Shoefly, Vuo, H2g2bob, Skatebiker, Gene Nygaard, Cnsupplier, Kbolino, Kenyon, Shimeru, JimJim, Linas, Mindmatrix, Jpers36, Davidkazuhio, Pol098, Slike2, Cbdorsett, Isnow, SDC, Zzyz11, Crucis, Marudubshinki, BD2412, Reisio, Saperaud-enwiki, Rjwilmsi, Hitssquad, Hezery99, Mzhaio, SMC, SnsH, Vegaswikian, Krash, Fred Bradstadt, GregAsche, Splarka, G Clark, UltraMako101, SiriusB, Nihiltris, Who, Gurch, A. Square, Lmatt, Srfleffer, Milomedes, Bgwhite, Adoniscik, YurikBot, Ugha, Wavelength, Jamesmorrison, Huw Powell, H005, Midgley, RussBot, DMahalko, Hellbus, Gaius Cornelius, Shaddack, Rskriant05, Anomalocaris, David R. Ingham, Bvanderveen, Grafen, Gerben49-enwiki, CaliforniaAliBaba, Voidxor, Saberyn, BucketofSri, Bota47, Jeh, Daniel C, Light current, PTSE, Tabby, E Wing, Shawnc, Geoffrey.landis, SorryGuy, Nimbex, Whouk, Charlie Tango, Lunarsurface, Some guy, SmackBot, FocalPoint, Karlchwe, Derek Andrews, Herostratus, InverseHypercube, Thorseth, AndreasJS, Mist0, Eskimbot, Nil Einne, Antifumo, Polaron, Chris the speller, Agateller, JesseStone, Oli Filth, EncMstr, Fluri, Analogue Kid, Adpete, Nbarth, Chendy, Dethme0w, Can't sleep, clown will eat me, Jacob Poon, OrphanBot, JonHarder, Xmastree, VMS Mosaic, Bassman2, Fuhghettaboutit, Jwy, LMF5000, Steve Hart, Dcamp314, DMacks, Jóna Pórunn, P373r, Dogears, DJIndica, Bige1977, The undertow, Anlace, John, Dwpaul, J 1982, Jaganath, Mggiganteus1, Peterlewis, Cielomobile, CoolKoon, Ckatz, Offby1, Soulkeeper, Slakr, Beetstra, Monni95, NJA, Peter Horn, JoeBot, Linkspamremover, Ziusudra, Rsteif, D'lin, Chetvorno, Vaughan Pratt, CRGreathouse, CmdrObot, Van helsing, Smile4ru, Cydebot, Peripitus, Kairotic, KarolS, Uniqueuponhim, Tawkerbot4, Punainen Nörtti, Andrewdmartin, Trev M, Saintrain, Ozgyu89, Thijs!bot, Pajz, N5iln, Drmemory, Chris01720, Electron9, Thomprod, Mailseih, Nick Number, CarbonX, Pap3rw8, Dawnseeker2000, Enyc, RoboServien, Trengarasu, Mentifisto, AntiVandalBot, Majorly, Gioto, Saimhe, Guy Macon, Opelio, Gh5046, Kuteni, Res2216firestar, JAnDbot, WmRowan, 100DashSix, Easchiff, Magioladitis, Bongwarrior, VoABot II, Yandman, Appraiser, Tomhannen, Cableguyjim, Kevinmon, Gutzmer, SandStone, Thibbs, Spellmaster, Halogenated, DerHexer, JaGa, WLU, Pinokijo, Cheesebyproduct, Yobol, Hdt83, MartinBot, Schmlloof, Quickmythril, Reguiee, SmokeySteve, Glrx, CommonsDelinker, Pekaje, Gutta Percha, Johnbravo, J.delaney, Mindgames11, Jesant13, Achuul8er, Metrax, PolychromePlatypus, Acalamari, Michael Daly, Katalaveno, PedEye1, Darkblast93, Afluegel, Mikael Häggström, Ephebi, ThomasNichols, Plasticup, NewEnglandYankee, Sparcules, Master shepherd, Johnnie ong, Cobi, Anatoly larkin, Atropos235, Remember the dot, Drablow, Funandtrvl, Lights, Uiew, CWii, TXiKiBoT, MilkTheImp, Shalom S., The Original Wildbear, Technopat, Hqb, Acjohns, Qxz, Qbert203, Whitepines, Piper8, Eubulides, Vladsinger, Andy Dingley, Cutemonkey77, Goldkills, Jpeeling, Buhin, Insanity Incarnate, Bitbut, C0N6R355, Bpdc 01, SieBot, Tresiden, TORQUEUNDB, Timothy Cooper, Yintan, Lumenteck, Steve19steve, Permacultura, Mിക്കea, Carnun, Hiddenfromview, 05, Macy, Ablamp, Anchor Link Bot, Tuntable, Leezahester, Dlhrohr2003, ClueBot, HujiBot, LP-mn, The Thing That Should Not Be, TinyMark, Techdawg667, EoGuy, Wysprgr2005, GreenSpigot, Mild Bill Hiccup, Uncle Milty, Sebokmike, Niceguyedc, Shjacks45, Drewster1829, Excirial, Life-ofFred, 12 Noon, MorrisRob, LarryMorseDCOhio, Iohannes Animosus, Tnxmnan307, WWriter, Aprout, 7, Versus22, GrahamDo, Elizabeth.baer, SoxBot III, Ostinato2, Weckmansj, Ginbot86, Strix nihilom, DumZiBoT, XLinkBot, Mjharrison, Theultimatezone, TimeToSell, Little Mountain 5, NellieBly, Badgernet, JinJian, Alchaemist, TheMINT400, Addbot, Cantaloupe2, Freakmighty, DOI bot, Energyqueen, Shirtwaist, Favonian, Berkunt, Tide rolls, Lightbot, טיף, TinaTimpton-enwiki, Lucacalciatore, DK4, Ben Ben, Legobot, Yobot, Zaereth, Themfromspace, Neotesla, Paraballo, A Stop at Willoughby, Amicon, AnomieBOT, BassmanIII, Kcgrant, Jim1138, Kingpin13, Mahmudmasri, Citation bot, Akilaa, Awinbisa, Sadrettin, Clark89, Quebec99, Jagcat98, Bluppen, Richard A Hall, Placidvortex, Capricorn42, Etoombs, Kidcharlemagne101, J04n, ELIOT2000, Letsgoridebikes, SPKirsch, Rainald62, Natural Cut, Krrish23, Mishka.medvezhonok, FrescoBot, Toby72, Hobsonlane, RicHard-59, JuniperisCommunis, Idyllic press, HJ Mitchell, Citation bot 1, Chenopodiaceous, Pinethicket, I dream of horses, Adlerbot, Fosekfotos, Tom.Reding, Calmer Waters, Pegasus33, Jschnur, Mifsud26, Gigantor205, Symppis, IJBall, DrLit, Khaotika, Alexey Goral-enwiki, Tbhotch, Minimac, DARTH SIDIOUS 2, RjwilmsiBot, Dirt-poorwizard, Jackehammond, Nmartin1, Bamaslamma1003, Teravolt, Slon02, EmausBot, Energy Dome, John of Reading, Annunciation, Chastitywest, Bigbird900, GoingBatty, K6ka, Richardop3, Thecheesykid, Drewpoleon, Mz7, Aura Light UK, Selladour, Westley Turner, H3llBot, X bvansanten X, Юрий Столетов, Donner60, DASHBotAV, 28bot, Autisexp235, ClueBot NG, Gareth Griffith-Jones, Jemova20, Brendon12291, DieSwartzPunkt, Maverick kim, Castncoot, Widr, GlassLadyBug, Reify-tech, Amir Fatkullin, CasualVisitor, Shakir Ahmed73, Boggle987, Helpful Pixie Bot, Calabe1992, Wbm1058, Alavanca-enwiki, Nature4, Silvrus, CitationCleanerBot, Emanukel, Michaelkevinjackson, Cocacolaibetterthanpepsi, BattyBot, Crankyfrank, ChrisGualtieri, Tagremover, Webclint101, 331dot, JRYon, Big-Matow, Pravito, Djaiprakash naidu, Lewis Goudy, Lucas.wogernese, Monkbot, Kenji Higurashi, Cdot25, MEGUSTANADAAARR, Hetalia paris12, Croakobsidian, Lcso2015, ZackQB and Anonymus: 727
 - Electric discharge** *Source:* <http://en.wikipedia.org/wiki/Electric%20discharge?oldid=645802617> *Contributors:* Bearcat, Wtshymanski,

Shaddack, Kkmurray, Chetvorno, Dthomsen8, Addbot, Luckas-bot, Pinethicket, Sumone10154, Seahorsruler, WikitanvirBot, Eleferen-Bot, Josve05a, Mburdis, ClueBot NG, 336, Wasbeer, Anarij, Tow and Anonymous: 9

- Plasma (physics)** *Source:* [http://en.wikipedia.org/wiki/Plasma%20\(physics\)?oldid=656359786](http://en.wikipedia.org/wiki/Plasma%20(physics)?oldid=656359786) *Contributors:* Trelvis, Vicki Rosenzweig, Mav, Bryan Derksen, Olof, AstroNomer-enwiki, Roadrunner, Secretsaregood, Heron, Stevertigo, Patrick, Michael Hardy, Tim Starling, Tapper of spines, Zeno Gantner, Ellywa, Stevenj, Jebba, Darkwind, Julesd, Glenn, Tantalate, Wikiborg, Reddi, David Latapie, IceKarma, Nv8200pa, Omegatron, Phoebe, Pakaran, Cdupree, April-enwiki, Donarreiskoffer, Robbot, Psychonaut, Moink, Hadal, Papadopc, David Edgar, SoLando, Dbroadwell, Wile E. Heresiarch, Gifflite, Mat-C, Art Carlson, MadmanNova, Monedula, Everyking, Jacob1207, Gracefool, Solipsist, Bobblewik, SarekOfVulcan, Beland, Mako098765, WhiteDragon, Gunnar Larsson, Karol Langner, APH, Icairns, Bk0, Nickptar, Iantresman, Kelson, Joyous!, Fermion, Jh51681, Deglr6328, Kate, PhotoBox, Spiffy sperry, Jiy, Noisy, Discospinster, Brianhe, Rich Farmbrough, Pjacobi, Vsmith, Florian Blaschke, Warpflyght, Bender235, Lou Crazy, Evice, El C, Huntster, Femto, Bobo192, Il-luvatar., Smalljim, Func, Enric Naval, Evgeny, .:Ajvol.:, Elipongo, Tmh, Maurreen, I9Q79oL78KiL0QTFHgyc, Sparkgap, Photonique, Boredzo, B0at, Obradovic Goran, Yoweigh, Danskil4, Alansohn, Anthony Appleyard, Ungtss, Arthna, Keenan Pepper, Craigy144, ABCD, RoySmith, PAR, Pion, SMesser, Radical Mallard, Knowledge Seeker, Cburnett, RJFJR, Sciuirinae, Mikeo, Vuo, Pauli133, DV8 2XL, Gene Nygaard, NuVanDibe, HenryLi, Pediddle, Umaphy, Brookie, Feezo, Stemonitis, Gmaxwell, Linas, Justinlebar, WadeSim-Miser, Mouvement, Jwanders, Fred J, SDC, Palica, Allen3, Mr Anthem, Marudubshinki, Mandarax, Aarghdvaark, Graham87, Teknic, BD2412, RxS, Kissekatt, Grammarbot, Canderson7, Ketiltrout, Rjwilmsi, Mayumashu, Koavf, Vary, Beng341, HappyCamper, Mbutts, Frenchman113, Krash, DoubleBlue, GregAsche, Yamamoto Ichiro, Algebra, Lcolson, MinorEdit, Eyas, The ARK, Old Moonraker, JohnElder, RexNL, Crouchingturbo, Preslethe, Srleffler, Kri, Physchim62, King of Hearts, Chobot, Helios, Tone, Roboto de Ajvol, Yurik-Bot, Borgx, Madhan49, Hairy Dude, RussBot, Conscious, Hydrargyrum, CambridgeBayWeather, Yyy, Shaddack, Giro720, Anomalocaris, Wiki alf, Bachrach44, Spike Wilbury, Grafen, NickBush24, Jaxl, JDoorjam, Nucleusboy, Brian Crawford, Coderzombie, Zirland, Figaro, DeadEyeArrow, Oliverdl, Kkmurray, Wknight94, Jezzabr, Tetracube, Nfm, Mütze, Tigershrike, Poppy, Phgao, zover0, Bobryuu, Theda, Closedmouth, Jwssick, Ameyabapat, Modify, Vicarious, Peter, Willtron, Katieh5584, Kungfuadam, RG2, MAROBROS, Dkasak, Mejor Los Indios, DVD R W, Vedant lath, That Guy, From That Show!, Mhardcastle, TravisTX, Lviatour, SmackBot, Superfreaky56, Unschool, Hkhenon, Sonoma-rich, CarbonCopy, Rex the first, Prodego, KnowledgeOfSelf, Wegesrand, Sharaiih, KocjoBot-enwiki, Fitch, FRS, Eskimbot, Jab843, Evanreyes, Yamaguchi, Brianski, Richfife, MPD01605, Bluebot, Thumperward, Miquonranger03, Mr Poo, SchfiftyThree, Complexica, Akanemoto, MIB4u, Baa, DHN-bot-enwiki, William Allen Simpson, Shamiryan, Exaudio, Can't sleep, clown will eat me, Ioscius, Berland, Rrburke, RedHillian, DavidStern, Nibuod, Ian01, John D. Croft, Astroview120mm, EdGl, SpiderJon, DMacks, Whoville, Mion, Bidabadi-enwiki, Tesseran, Sina2, Kuru, John, JorisvS, IronGargoyle, Ben Moore, Applejuicefool, S zillayali, Frokor, Slakr, SCOTT FISHER, Dicklyon, Waggers, Mets501, Dr.K., Arstchnca, P199, MathStuf, DI2000, Tusenfem, Iridescent, Electrified mocha chinchilla, Laurens-af, Polymerbringer, Joseph Solis in Australia, Tony Fox, Tawkerbot2, Dlohcierekim, Jafet, DanHickstein, Tommysun, JForget, Sakurambo, CmdrObot, Tanthalas39, Sir Vicious, Alexey Feldgendler, Neachili, Van helsing, Jcoetzee, JohnCD, Bill.albing, PRhyu, Dgw, Dashpool, Rigby-enwiki, Gegorg, MarsRover, Shandris, Inferno32, Guitarmankev1, Tjoneslo, Myasuda, Eecon, Cydebot, Lightblade, W.F.Galway, ArgentTurquoise, Corpx, Bazzargh, Quibik, Gerinych, DumbBOT, Thijs!bot, Epr123, Andyjsmith, Dougsim, Headbomb, Marek69, FST777, Dawnseeker2000, Elert, Escarbot, Ileresolu, AntiVandalBot, Amideg, Widefox, Seaphoto, Blue Tie, Opelio, Zachwoo, Joe Schmedley, Stepan Roucka, JAnDbot, CosineKitty, Plantsurfer, Andonic, East718, Howsthatfordamage25, PhilKnight, Rotherpe, Acroterion, FaerieInGrey, Mg007, Magioladitis, Wizymon, Kilogray, Karlhahn, Pedro, FJM, Jjpratt, Swikid, Bong-warrior, VoABot II, Mgmirkin, Sushant gupta, Mindgame123, مياسم, Rich257, Nikevich, ClaudeSB, Indon, Cgingold, JJ Harrison, Efwiz, 793184265, Just James, DerHexer, EightBall1989, Edward321, Khalid Mahmood, TheRanger, SquidSK, Zahakiel, MartinBot, Sm8900, Kostisl, CommonsDelinker, Leyo, Ash, Conundrumer, Tgeairn, Manticore, J.delanoy, Xhb, 2012Olympian, Hans Dunkelberg, Rhinestone K, All Is One, Eliz81, AgainErick, Martino3, RIckOzone, Davidprior, Shawn in Montreal, Katalaveno, McSly, TheTrojanHought, Aftuegel, Coollettuce, SJP, Killer Chao, KylieTastic, Juliancolton, Bogdan-enwiki, Strig, Remember the dot, Gwen Gale, Nigelloring, Mike V, S, Izno, CardinalDan, Idioma-bot, Spellcast, Beatnik Party, Macedonian, Soliloquial, Philip Trueman, PNG crusade bot, Malinaccier, RagnarokEOTW, Hqb, Andrewrchen, Ask123, Someguy1221, Corvus cornix, Plasmadyne, Saibod, LeaveSleeves, Opiate5555, Ilyushka88, Guest9999, Maxim, Ilke71, Madhero88, K10wnsta, Nagy, Kharissa, Wagaf-d, Insane Burner, News0969, Hmwith, Noobz1112, Hans-wai, Derfel071, Linarutouzumaki, Qlarsen, RJaguar3, Smsarmad, Yintan, Revent, Stonejag, Djdan4961, YemeniteCamel, Flyer22, Tip-toety, James.Denholm, Sunday8, Dingemansm, LarryRiedel, Huevosgrandes, DevOhm, Hardware Hank, Svick, Reginmund, Vituzzu, C'est moi, Spartan-James, Bharatmittal2007, Bwili00, Mygerardromance, Hamiltondaniel, Dust Filter, DRTlbrg, Denisarona, Velvetron, Atif.t2, Jrw6736, Kunak, Martarius, Jiminezwaldorf, ClueBot, Rumping, Connor.carey, GorillaWarfare, Cigarshaped, The Thing That Should Not Be, Liverspoolian!, Rjd0060, MahriMan, Wysprgr2005, Sterlsilver, Alex Lazar, Rzmies, Razimantv, CounterVandalismBot, Neverquick, Neffe22, LeoFrank, Excirial, John Nevard, Wpkiuser96, Megiddo1013, Tyler, Dspark76, Subdolous, Editor510, BOTarate, Aitias, Kruusamägi, ShipFan, AnonyScientist, Crownsnest, HtmlcodereXe, Deathknightlord, 03md, XLinkBot, Vivaviagra, Fastily, Spitfire, Gnowor, Roxy the dog, Aldude14, NatulisKaos, Ost316, Avoided, Skarebo, Petedskier, M2o6n0k2e7y3, Mhsb, Firebat08, Eleven even, JinJian, Raso mk, Earvy, Marian123456789, Addbot, Some jerk on the Internet, Wiki guy752, NVLAUR, Fgnievinski, Devansh.sharma, 15lsonky, Fieldday-sunday, CanadianLinuxUser, Leszek Jańczuk, Ashanda, MrOllie, Maniac7553, Ld100, MrAnderson7, BobMiller1701, Justpassin, Numbo3-bot, Jdawg34520, Tide rolls, Jan eissfeldt, Ostrichdude7, Gail, Ochib, Yobot, TaBOT-zerem, DisillusionedBitterAndKnackered, Fizyxnrd, Wikipedian2, Tamtamar, Eric-Wester, MacTire02, Vsalimova, AnomieBOT, Eminem69041, Iexec1, Jim1138, IRP, Galoubet, World-Famous K-Mart, Piano non troppo, Dinesh smita, EryZ, MaterialsScientist, Spirit469, Rtyq2, The High Fin Sperm Whale, Citation bot, Jamad, LouriePietere, OllieFury, Maxis ftw, Neurolysis, Hammack, Hatchetman459, Capricorn42, Melifluous One, Gilo1969, Romodahomo, Tomwsulcer, Inferno, Lord of Penguins, WingedSkiCap, Brflorance, Blungee, YukioSanjo, Ruy Pugliesi, Nayvik, Honeyfur, Franco3450, Bellerophon, JediMaster362, Terrierhere, Shadowjams, RDC23, AutoMe, LucienBOT, Originalwana, Paolo Di Febbo, Danzence, Recognizance, Saehriminr, Hgevs, Kthapelo, Allowrocks2003040957, Drew R. Smith, Citation bot 1, Pinethicket, I dream of horses, Boulaur, Eloclid, Hard Sin, Jonesey95, Tom.Reding, V.narsikar, RedBot, KaliHyper, Continue-WithCaution, Jauhienij, IVAN3MAN, Gamewizard71, FoxBot, Iæfai, ItsZippy, Sternenstaub-enwiki, Vrenator, Begoon, Raidon Kane, Reaper Eternal, Stalwart111, Pedalle, Pranavsharma67, Jhenderson777, Adi4094, Earthhandmoon, Unbitwise, Pimp3245, Minimac, Angelito7, DARTH SIDIOUS 2, Whisky drinker, NameIsRon, Legofreak666, Beyond My Ken, Cjc38, EmausBot, WikitanvirBot, Optiguy54, Smithu1976, Kavantiger62, Wikipelli, Billy9999, JSquish, Susfele, Claudio M Souza, Fæ, Melmaola, UI, PMcQuillen, Sivaraman99999, A930913, Wayne Slam, Tolly4bolly, Rassnik, Maxfisch, Donner60, Orange Suede Sofa, ChuispastonBot, Explica, Rocketrod1960, Jungleback, Warharmer, Yamagawa10k, Rudolfensis, ClueBot NG, La bla la, Chocolateoak, SusikMkr, Moves-bot, Iwsh, GoldenGlory84, The-OriginalMexi, Abdossamad Talebpour, Lookb4uleap, Frietjes, Mesoderma, Marechal Ney, Widr, Mtheodric, Pluma, MerllwBot, Helpful Pixie Bot, Ba11zooka, Bibcode Bot, WNY98, Midashboy, Lowercase sigmabot, BG19bot, Northamerica1000, Sol1869, MusikAnimal, Leo Yeei, Juuomaqk, Vincent Liu, Ninney, FutureTrillionaire, PlasmaSoul, Bapi 123, Trevayne08, Sparkie82, Shawn Worthington Laser Plasma, Glacialfox, BattyBot, Joems1324, WhiteNebula, Devin 496, APerson, Dexbot, Mogism, Denis Fadeev, Saehry, Lugia2453, Isarra (HG), Plasmafroid, Moodilman, Jamesx12345, All126 at wiki, Mruthun Rajkumar, Mark viking, Ruby Murray, Paraneoz, AmarylIsGar-

dener, Eyesnore, 2cuteforyou, CarbonLawyer, Three1two, Backendgaming, Qwertysdfqwertyfdsa, Wikisekharja, Dhdpla, ReconditeRudent, The Herald, Prokaryotes, Ultimorino, VirusEditor, Anrnusna, Meteor sandwich yum, JaconaFrere, CHEZBALZ, KillerBottox123, Mickedice, Rahup007, Сяра, Adamekjiri, Asdfghjkl1234567890zxcvbnm, Fleivium, Brant9922, Narliu, Stefan.nettesheim, Tetra quark, Khalood246, Samfart20 and Anonymous: 1032

- Compact fluorescent lamp** *Source:* <http://en.wikipedia.org/wiki/Compact%20fluorescent%20lamp?oldid=662087953> *Contributors:* Maartsen, David spector, Heron, Yaginuma, Ewen, Edward, Bdesham, Michael Hardy, Dcljr, Karada, Delirium, Flamurai, Docu, Julesd, Glenn, Jeandr  du Toit, Radiojon, Dragons flight, Fibonacci, Rei, Omegatron, Indefatigable, Shantavira, Huangdi, Nurg, Postdlf, Rfc1394, Hendry, Auric, Qwm-enwiki, Mdrejhon, Robartin, Pengo, Aomarks, Giftlite, Nroose, DocWatson42, Dinomite, BenFrantzDale, Ds13, Varlaam, Gecko-enwiki, Jason Quinn, Bandy, Mboverload, Jackol, MSTCrow, OldakQuill, Chowbok, 159753, Andycjp, Beland, Eregli bob, Zantolak, Information Ecologist-enwiki, Rogerzilla, ScottyBoy900Q, LHOON, Neutrality, Joyous!, Ensriffraff, Askewchan, Deglr6328, Montereyham, EagleOne, Mnadi, Shotwell, Mike Rosoft, N328KF, TheK, JTN, Clawed, ArnoldReinhold, Smyth, Narsil, Adam850, Alistair1978, Stbalbach, Bender235, ZeroOne, Thebrid, El C, Art LaPella, Dennis Brown, West London Dweller, Bobo192, Nigelj, Spalding, Meggar, Desultor, Smalljim, Marked, Elipongo, Giraffedata, Zr40, PiccoloNamek, Timecop, Pearle, Hooperbloom, Nsaa, Alansohn, Gary, TheParanoidOne, RPaschotta, Eric Kvaalen, Arthana, Atlant, Keenan Pepper, Pen1234567, Jaardon, Malo, TheRealFennShysa, Wshymanski, Stephan Leeds, LFaraoe, Wadems, Versageek, DV8 2XL, Gene Nygaard, HenryLi, Brycen, Stemonitis, Billhpikie, MartinSpacek, Mindmatrix, Tyz, Pol098, Timrichardson, Ortcutt, Tabletop, Bkwillwm, Ferg2k, Firien, TreveX, GregorB, Zzyzx11, PeregrineAY, Rgbea, Emerson7, Mandarax, Lawrence King, Wraybm1, Karlww, Reisio, Edison, Rjwilmsi, CustardJack, Hezery99, XP1, PHenry, Rkeene0517, Jared999, Bubba73, StephanieM, AySz88, Splarka, Windchaser, Nihiltres, Wongm, Atrix20, Lmatt, Preslethe, Sreffler, Knife Knut, Adoniscik, Uriah923, Jamesmorrison, Hairy Dude, StuffOfInterest, WAvegetarian, JabberWok, Hellbus, Hydrangyrum, David Woodward, Lavenderbunny, Plasmamatx, WulfTheSaxon, Crumb, Manuelhp42, Doctorindy, Speedevil, Voidxor, Allisonok, Mugwumpjism, Pablomartinez, Caspian, Peggy Brennan, Tonywalton, AjaxSmack, Twelvethirtheen, StuRat, Lab16, Closedmouth, Besselfunctions, D'Agosta, MrVoluntarist, BorgQueen, GraemeL, Dyefade, Back ache, Geoffrey.landis, El T, Crid, Airodysey, Katieh5584, Charlie Tango, JDSpeeder1, Bernd in Japan, Anthony717, Attilios, SmackBot, Jclerman, Ashill, Tobias Schmidbauer, Hydrogen Iodide, Thorseth, AndreasJS, Ace of Risk, Dellidot, Xmedh02-enwiki, Cessator, Nil Einne, Gilliam, Brianski, Quotemstr, Gelingvistoj, Evilandi, KD5TVI, Thumperward, Trikmc, Rogerhc, Caliston, Hibernian, Neo-Jay, Baa, Croquant, Colonies Chris, Redline, Darth Panda, Steinninn, Invenio, Brideshead, E946, Jp498, Citronym, Nixeeagle, VMS Mosaic, Xyzyzplugh, Jerrch, Kneale, Shadow1, DMacks, Just plain Bill, Kendrick7, Salamurai, Mion, Springnuts, J.smith, Bdushaw, Dogears, Bige1977, Esrever, AThing, Anlace, DireWolf-enwiki, Dreslough, Zaphraud, Quasispace, Shlomke, Peterlewis, Springbox, Stwalkerster, Makyen, TheHYPO, Beetstra, Mr Stephen, NJA, Sharcho, Dacium, Nehrams2020, Shawn D., Iridescent, Missionary, Chris53516, JustinRossi, KsprayDad, Maelor, Linkspamremover, Bitsecure, Polypipe Wrangler, Tawkerbot2, Chetvorno, Slippyd, Flyingscot, Bayberrylane, Gaunt, Hirovox, CRGreathouse, CmdrObot, Mikemee, Notclive, Geoffmyers, CuriousEric, Bmk, Myasuda, Lironl, Monophoto, Cydebot, Blaiq, Gogo Dodo, Khattru2, Jedonnelley, Odie5533, Q43, Slordak, Xarvia, EqualRights, Gimmetrow, Trev M, Xanthis, Ozguy89, Rjm656s, Epbr123, Skreyola, Pajz, KimDabelsteinPetersen, N5iln, Rosarinagazo, Bobblehead, Pastafarian Nights, Kathovo, Electron9, Mattfiller, Mailseth, CharlotteWebb, Brian1711, Viralmemesis, Quaxanta, Ssprince, Saimhe, Seaphoto, MongrelDog, Quintote, Marokwitz, RapidR, Pwhitwor, Gregalton, Pichote, Jimj wpg, Bobguy89, JANdbot, Leuko, Davewho2, Wilee, MER-C, Hydro, Truth4Sale, JustinBaeder, PubliusFL, Crcrcrcr, Coolhandscot, Prospect77, RainbowCrane, GGreeneVa, Time3000, Accuracy, Bongwarrior, VoABot II, Saifiyaseen, Dekimasu, Alexultima, Wookieepedian, Skew-t, Nikevich, WODUP, BrianGV, Catgut, Theroadislong, Benjamintchip, DerHexer, JaGa, Rmac-enwiki, TheRanger, Jdorwin, Seba5618, Alihasnain, Black Stripe, Atulsnischal, MottyGlicksman, Jkawula, Yobol, MartinBot, Quickmythril, Aritel., Reguiee, Jim.henderson, Nikpapag, Anaxial, Johnibravo, Lilac Soul, Wiki Raja, Eplack, J.delanoy, Candleknight, Uncle Dick, Jesant13, Professor Magneto, Giligone, Acalamari, Katalaveno, Coolbrook76, Ncmvocalist, Silas S. Brown, Mikael H ggestr m, Hemens, AntiSpamBot, Plasticup, Dapups, Alphastream, NewEnglandYankee, Mrdavenport, Pintobeaner, Lloydic, Anatoly larkin, Olegwiki, Scforth, MetsFan76, Dodge1884, Charlie2301, Totsugeki, Remember the dot, Tygrrr, VoidLurker, WikipediaSq, Nat11, Amkosolara, Useight, Pjpcp1, 7SeveN7, Intangible2.0, Beckyvolley, Funandtrvl, Yuandrew, Signalhead, X!, VolkovBot, EEye, CWii, Johnfos, Indubitably, Soliloquial, Kuebi, MichaelSchoenitzer, Fagiolonero, Philip Trueman, Fluffybin, TXiKiBoT, MilkTheImp, Jalwikip, Hmilne, Anna Lincoln, BringItOn TheAteam, Lradrama, Canol, Sintaku, Dave.Hulick, Jackfork, Bodybagger, GeneralBelly, Joren, MikaNystrom, SheffGruff, Q Chris, Piper8, SergioGeorgini, Youmustbejoking, Eubulides, Andy Dingley, Kilmer-san, Gillyweed, Greentopia, Vchimpanzee, Temporaluser, Riversong, Brianga, Michael Frind, Yak99, Discdeath, Tom NM, Macdude55, SieBot, AlasdairBailey, Homeawarder, Tiddly Tom, Springbok26, ITBlair, Tonycom, Krawi, Muttonking, Energy Resources, Nibormac, Grundle2600, Steve19steve, Little.green.bulb, Kleptog, Neutralhomer, Theaveng, Jojalozzo, Nopetro, Sta3bha, Mdsam2-enwiki, Rabidpoobear, Rwarring, Techman224, Hobartimus, Jimad, Bsilby, Kumioko, XU-engineer, Npw001, Prgyu72, Ablamp, Capitalismojo, Mygerardromance, Sapeli, SuperXero07, Olivarries, Escape Orbit, Dlhrohrer2003, Atif.t2, ClueBot, LP-mn, Binksternet, Snigbrook, 3sticklerz, The Thing That Should Not Be, Sootyandsweep, Aberlini, Wispanow, Centenarian, SecretDisc, Elegie, Martinwj53, Redcliffe92, Blanchardb, Otolemur crassicaudatus, Puchiko, Auntof6, PMDrive1061, IceamanJ256, Fink222, Srjsignal, DragonBot, Kjramesh, Three-quarter-ten, Cosmic Y, Bender2k14, John Nevard, Rct36, Imanferri, Wardjon31, Arjayay, LarryMorseDCOhio, Acas7110, KLWhitehead, Valdica, ChrisHodgesUK, Ghanadar galpa, Looktothis, Thingg, Bigturnip, Smarkflea, Ginbot86, Vanished User 1004, DumZiBoT, Finalnight, XLinkBot, Watsos, Sacratimethod42, C. A. Russell, Avoided, TFOWR, New Avian, Markdavis11, Benboy00, Bit Lordy, Zodon, Enecon77, HexaChord, Bradwhite25, Addbot, Mortense, Cantaloupe2, Paolo Benedetti, Knewberg, Haroldn, Bolegash, Incraton, Nayyer Aftab, K00kykelly, Tekvax, Coolnrg, Numbo3bot, Rehman, Tide rolls, Bfigura's puppy, Hotshotharry, Red flag33, Pietrow, Gail, Zorrobot, Luckas-bot, Yobot, Fraggel81, Bathandbristol, Legobot II, Screechman777, II MusLiM HyBRiD II, Amirobot, Eric-Wester, Nasier Alcofribas, Retro00064, AnomieBOT, SamuraiBot, Captain Quirk, Yachtsman1, B137, MaterialsScientist, ImperatorExercitus, Paranormal Skeptic, Citation bot, Maxis ftw, Frankenpuppy, ArthurBot, Stephen862, H9e3k80, Obersachsebot, Xqbot, Richard A Hall, Louhughes, Shiva (Visnu), Ewick12, Conay, Capricorn42, The Magnificent Clean-keeper, DSisyphBot, J04n, Wikignome0529, Nenad80, TB42, A Quest For Knowledge, Tjampman, KuleKat, Bobdexta, FrescoBot, Illustria, Yiyi303, Barsuz, HJ Mitchell, Eagle4000, Eddyhotrod, Velociostrich, Intelligentsium, Pinethicket, Robbieferguson123, Tom.Reding, Leboite, Skyerise, IceBlade710, Meaghan, Full-date unlinking bot, AlterEco1, Transope, Yzerman123, Wayne Riddock, Elekh, TobeBot, Nimbow7, Masscommuter, Vrenator, Dc987, Dennyfranklin, Coercorash, Hotsugerlips, Ivica Vlahovi , Stev-o perrelli, Vengeance of the English Language, Stroppolo, PAnderson88, SeanBrockest, Pluemaster, RjwilmsiBot, NamelsRon, Ar21, Jeraxbeckwith, Worldwaroneobsessed, John of Reading, Seamos, Santamoly, WikitanvirBot, Look2See1, Nallen630, Sherazade96, IncognitoErgoSum, GoingBatty, Wikipelli, Seikku Kaita, MikeyMouse10, Bollyjeff, LMRoberts, Maychill1101, Elektrik Shoes, H3llBot, Rexprimoris, EWWikist, Bsansvsage, Onechange, Seattle, RightLight, Yerocus, Glennjamieson, Hoppyh, Green8019, Mattgregg22, TurtleMelody, InforManiac, Amarite1, ChuispastonBot, EdoBot, Sonicyouth86, Mikhail Ryazanov, ClueBot NG, Brendon12291, Deweeese, DieSwartzPunkt, Gawds-mak, Duanetharp, JLFahey, Spel-Punc-Gram, Widr, Boggle987, Helpful Pixie Bot, Indigophox, EeSGroup, TheProEditorLolz, BG19bot, Mhakcm, Tom Pippens, Tobias "ToMar" Maier, Altair, RedNeckChris, Petesmith5555, BattyBot, Pratyya Ghosh, Chakkukumar, Cerabot-enwiki, Michael Anon, Jmazing9512, Lugia2453, BigMatow, Shokhrukhuz1, Mydreamsparrow, Polytope4d, Ruby Murray, 22jeffer-

sonz, Rybec, Spylglasses, Rain.tanthera, Prabhupuducherry, Cleopatra Bear, ClydeCyle, Monkbot, Bp1485, Tspielman, J73364, Casetwebs and Anonymous: 932

- **Neon lamp** *Source:* <http://en.wikipedia.org/wiki/Neon%20lamp?oldid=653457013> *Contributors:* Heron, RTC, Michael Hardy, Tim Starling, Tregoweth, Glenn, Cyan, Andres, Mulad, Reddi, Omegatron, Rnbc, Wirehead, Hadal, Alan Liefing, MPF, Wwoods, Neilc, Gadium, Utorsch, Beland, Archer3, Hydrox, Wikiacc, ArnoldReinhold, Neko-chan, Fenice, CanisRufus, Femto, Bert Hickman, Eric Kvaalen, Atlant, Saga City, Wtshymanski, Gene Nygaard, Cnsupplier, Oleg Alexandrov, LizardWizard, Georgia guy, Bratsche, Benbest, Hailey C. Shannon, GregorB, Julo, Prashanthns, Saperaud-enwiki, Ceinturion, Zxcxcz, FlaBot, Directorblue, Lmatt, Srleffler, Chobot, RussBot, Hede2000, Hellbus, Shaddack, Speedevil, Maerk, Adicarlo, Light current, Closedmouth, Tabby, GraemeL, DVD R W, SmackBot, Redline, Master Scott Hall, SashatoBot, John, BobbyLee, Yves-Laurent, Charleenmerced, Chetvorno, KerryVeenstra, DonalWaide, Circuit dreamer, Odie5533, Headbomb, CharlotteWebb, Rees11, John Jarman, JAnDbot, Instinct, Arch dude, Davidpage, SiobhanHansa, Easchiff, VoABot II, Xwiz, Vssun, Glrx, J.delanoy, Zlongbow, MKoltnow, Potatoswatter, Funandtrvl, Flyingidiot, IceHorse, NuclearChaos, Hrothberht, Chaoborus, SvNH, Scarian, Cwkmail, Oxymoron83, Partyinyourpants, Wdwd, ClueBot, Intllighttech, Snigbrook, The Thing That Should Not Be, Mild Bill Hiccup, CounterVandalismBot, Flippytheganster, LarryMorseDCOhio, Aitias, SoxBot III, Ginbot86, DumZi-BoT, Teslaton, Addbot, D0762, CanadianLinuxUser, SomeUsr, OIEnglish, Matt.T, PieterJanR, Luckas-bot, Yobot, AnomieBOT, Gargan26, Jim1138, ArthurBot, RibotBOT, Fotaun, Bobabowie, 10metreh, Asided m plane, Dianna, Unbitwise, Teravolt, EmausBot, John of Reading, GoingBatty, Mkrazt, Chemicalinterest, SporkBot, Noggo, ClueBot NG, Strawberries x, Helpful Pixie Bot, Mark Arsten, Mdy66, Jodosma and Anonymous: 106
- **Mercury-vapor lamp** *Source:* <http://en.wikipedia.org/wiki/Mercury-vapor%20lamp?oldid=651900264> *Contributors:* Bryan Derksen, Caltrop, Edward, Glenn, Smack, Conti, Slawojarek, Hoolooovo, LucasVB, Famartin, DmitryKo, Cfaiide, Izogi, Torindkflt, Meggar, Timichio, Atlant, PAR, Theodore Kloba, Wtshymanski, Skatebiker, SDC, BD2412, Rjwilmsi, Leeyc0, Azure8472, Nihiltres, Lmatt, Srleffler, YurikBot, Jengelh, Hellbus, Hydrargyrum, Stephenb, Anomalocaris, DragonHawk, Giltramirez, Kkmurray, Light current, Pb30, Guilom, That Guy, From That Show!, Galidakis, SmackBot, Herostratus, Chris the speller, Pieter Kuiper, MalafayaBot, Redline, Dethme0w, Mulvany, VMS Mosaic, Senatorpjt, SirLamer, MichaelBillington, Dogears, Missamo80, BDM, Mlgiganteus1, BranStark, Tawkerbot2, Chetvorno, CRGreathouse, Karenjc, Mike Christie, Gogo Dodo, Thijs!bot, Headbomb, MastoReality, Ileresolu, Serpent's Choice, SFloridamusic, QuantumEngineer, Fozterchild, Ebowdish, Vssun, Torsionalmetric, Tpirman1982, Nemo bis, DorganBot, D-Kuru, VolkovBot, Malinaccier, PDFbot, SieBot, Steve19steve, Travis Evans, Yerpo, Arjen Dijkman, Legionarius, Mrjkb, Repat, ChrisHodgesUK, BO-Tarate, Addbot, DOI bot, Danago1990, Persistence101, Tylercat5, Williamhortner, Ben Ben, Luckas-bot, AnomieBOT, Galoubet, MaterialsScientist, Citation bot, Gailgrove, Akilaa, Roux-HG, ArthurBot, ELIOT2000, Yoganate79, Hyperboreer, Weetoddid, BioImages2000, Kukdide, Tom.Reding, Marcopete87, 777sms, Bcai388, Sideways713, دالبا, Kyle1081, Charbon, LMRoberts, Nasdram, ClueBot NG, Knownik, Helpful Pixie Bot, Canoe1967, BattyBot, Bulandi, Qxukhgiels, SoledadKabochoa, Tom Appel, ARD1988, Keith wylie, Monkbot, PJCwic and Anonymous: 109
- **Sodium-vapor lamp** *Source:* <http://en.wikipedia.org/wiki/Sodium-vapor%20lamp?oldid=655380753> *Contributors:* Bryan Derksen, Julesd, Glenn, Radiojon, LMB, Rnbc, Donarreiskoffer, Gentgeen, Boffy b, Securiger, Dbenenn, DocWatson42, Dinomite, BenFrantzDale, Monedula, Curps, Leonard G., Jfdwolff, Icairns, Sonett72, Famartin, QuiIche, Pmsyzz, Izogi, Mwanner, Deanos, JRM, Meggar, Viriditas, Foobaz, Atlant, PAR, Wtshymanski, VivaEmilyDavies, Egg, Skatebiker, Freyr, Gene Nygaard, GregorB, SDC, Emerson7, DavidCane, Eteq, Rjwilmsi, Bubba73, Klosterdev, Maltmomma, Lmatt, Srleffler, Eric B, Debivort, Siddhant, Shaddack, Praseodymium, Voidxor, Geofrey.landis, That Guy, From That Show!, Galidakis, SmackBot, Marc Kupper, Chris the speller, Bluebot, Thumperward, EncMstr, Jerome Charles Potts, EdgeOfEpsilon, Redline, OrphanBot, Ghiraddje, Pusher robot, Dogears, Khazar, BDM, Coredesat, Mlgiganteus1, Dicklyon, Hetar, Sakurambo, Mikiemike, Raz1el, Chasingsol, Thijs!bot, Eprb123, Headbomb, Jgreenberg, Widefox, Tjmayerinsf, Arch dude, Saustin-enwiki, Moralist, VoABot II, Grimlock, Xochimec, JJ Harrison, Vssun, HuntClubJoe, Pekaje, Ginsengbomb, Wa3pxx, Totsugeki, Useight, Idioma-bot, ABF, Dqeswn, Triskele Jim, TXiKiBoT, Liquidcentre, Cloudswrest, Jackfork, StarlightCBL, BigDunc, Hertz1888, Jojalozzo, Ks0stm, Legionarius, Hamiltondaniel, Twinsday, ClueBot, JohnG62, Drlightx, Airplaneman, Cluginbuhl, Addbot, Jim10701, Pince Nez, Numbo3-bot, Gail, Luckas-bot, Yobot, Metalhead94, Jim1138, 9258fahsflkh917fas, Mahmudmasri, ArthurBot, JSund, HEBus, Atlantia, Tom.Reding, Double sharp, Trappist the monk, Ferang, Bcai388, دالبا, RjwilmsiBot, John of Reading, WikitanvirBot, Agent L, Flushing258, LMRoberts, Anonimski, ClueBot NG, Jack Greenmaven, Raghith, Helpful Pixie Bot, BG19bot, Ramesh Ramaiah, Piguy101, RossHiga, Km45620, Pedro Xing, Spylglasses, Tbarrell, Monkbot, SoulRebel56, Kyle1009 and Anonymous: 124
- **Sulfur lamp** *Source:* <http://en.wikipedia.org/wiki/Sulfur%20lamp?oldid=656659214> *Contributors:* Bryan Derksen, Maury Markowitz, Glenn, Radiojon, L-Bit, Andycjp, LHOON, Deglr6328, Chris Howard, Harriv, Violetriga, Sparkgap, Echuck215, Gene Nygaard, SDC, Rjwilmsi, Lmatt, Srleffler, Piet Delpont, Hydrargyrum, CambridgeBayWeather, Bovineone, Tetsuo, Thiseye, Kkmurray, SmackBot, Antifumo, OrphanBot, A5b, CoolKoon, PRRfan, TastyPoutine, Chetvorno, CmdrObot, Jesse Viviano, Requestion, Corpx, Difluoroethene, 2z2z, Thijs!bot, Saimhe, Marokwitz, Spartaz, LorenzoB, Beagel, Nono64, Dispenser, Oldboltonian, Remember the dot, Malik Shabazz, Dqeswn, PNG crusade bot, LeaveSleaves, Fuzzywallaby, Calliopejen1, Mickea, Ciaran01, ImageRemovalBot, DumZiBoT, Addbot, Lightbot, OIEnglish, MaterialsScientist, LilHelpa, TB42, Wiki1ply, Tom.Reding, H3ilBot, Mikhail Ryazanov, BattyBot and Anonymous: 43
- **Electrodeless lamp** *Source:* <http://en.wikipedia.org/wiki/Electrodeless%20lamp?oldid=656521889> *Contributors:* William Avery, Heron, Michael Hardy, Gjbloom, Glenn, Radiojon, Markhurd, DocWatson42, Icairns, Ukexpat, Deglr6328, Alexburke, Violetriga, Atlant, Wtshymanski, Emvee-enwiki, Lee-Anne, Gene Nygaard, Woohookitty, RHaworth, SDC, BD2412, JamesBurns, OmegaPaladin, Wahoofive, Ian Pitchford, Lmatt, Srleffler, YurikBot, Pburka, Bhny, David R. Ingham, Gerben49-enwiki, JustAddPeter, 2over0, Chriswaterguy, Backache, Jclerman, Nihonjoe, Edgar181, Lovecz, TimBentley, Colonies Chris, Cfallin, Bruce Marlin, Dogears, Harryboyles, CoolKoon, Torrazzo, Chetvorno, Vanisaac, Climber rich, Brandon.macuser, Thijs!bot, Electron9, Yoricky, D.H, Dougher, Schmlroof, Totsugeki, Amkosolara, Idioma-bot, GLPeterson, Vitund, Wikidemon, Falcon8765, Joeg99, Jerryobject, Npw001, Ciaran01, ClueBot, Mild Bill Hiccup, Fenwayguy, Sun Creator, Davidduck, Dusen189, XLinkBot, Monrio, Addbot, Queenmomcat, Marexim, Pnpointer, Luckas-bot, Yobot, Ptbogourou, KamikazeBot, AnomieBOT, Jim1138, MaterialsScientist, GB fan, LilHelpa, V35b, Xqbot, Partypower, FrescoBot, Tjbrockett, Full-date unlinking bot, Topher4228, Flensburger47, Teulon3000, Menlopark1, Ripchip Bot, Seamos, LMRoberts, 'O ὀϊστορ, USLEADER, Mattgregg22, Superbee1970, ClueBot NG, Emailtopeterson, BG19bot, Boris3233, Rituraj.shukla, YodaWhat, Devclark, SoledadKabochoa, QLCCompany, Workingman2013, User3932, Vdroberts and Anonymous: 83
- **Electric light** *Source:* <http://en.wikipedia.org/wiki/Electric%20light?oldid=654101355> *Contributors:* Vicki Rosenzweig, BckkNght, Heron, Michael Hardy, Tregoweth, Mulad, Topbanana, Jerzy, David.Monnaux, AlexPlank, Rholtan, Michael Snow, Lupin, Curps, Sam Hocevar, Surfingslovak, O'Dea, Guanabot, SpookyMulder, Chairboy, Hooperbloom, Ekko, Wtmitchell, Wtshymanski, Skatebiker, DV8 2XL, Gene Nygaard, HenryLi, Simetrical, RHaworth, Camw, Timrichardson, MONGO, JRHorse, SCEhardt, Isnow, SDC, Waldir, Sjakkalle, Srleffler, Imsoclever, Mythsearcher, Robertvan1, Benhoyt, SmackBot, Nihonjoe, Marc Lacoste, Gilliam, JMSwtlk, Jeysaba, Adam Clark, Sgt Pinback, Iridescence, Mathias-S, Jayus, Chetvorno, CRGreathouse, Scohoust, AntiVandalBot, Magioladitis, VoABot

- II, JaGa, Esanchez7587, Tonicthebrown, J.delanoy, Zlongbow, FeralWolf, M-le-mot-dit, Thegreenbook, Iiketooty, Woowho, Dirkb, Synthobot, Calin999, SieBot, ClueBot, Jthm guitarist, Hafspajen, Goldkingtut5, DragonBot, Dekisugi, Destroyman, MystBot, Jncraton, Download, CarsracBot, YoMenashe, Suwa, Legobot, Yobot, AnomieBOT, Giants27, Tinton5, Chawla.mohali, Keegscee, NerdyScienceDude, John of Reading, Xanchester, ClueBot NG, DieSwartzPunkt, ChrisGualtieri, Qxukhgiels, Sonic3466, Pedarkwa, Jack.belk and Anonymous: 62
- OLED** *Source:* <http://en.wikipedia.org/wiki/OLED?oldid=660867781> *Contributors:* Damian Yerrick, AxelBoldt, Magnus Manske, Rjs-tott, Csx, Merphant, DrBob, Azhyd, David spector, Heron, Michael Hardy, Dgrant, Mac, Baylink, Julesd, Glenn, Rossami, Lommer, Feedmecereal, Emperorbma, Ec5618, Stone, Tmc, Quux, Nv8200pa, Wernher, Chuunen Baka, Donarreiskoffer, Hankwang, Pbrooks, Nurg, Auric, Hadal, LX, Fuelbottle, Javidjamae, Giftlite, Graeme Bartlett, DocWatson42, Snags, BenFrantzDale, Netoholic, Chinasaur, Rchandra, Khalid hassani, Matt Crypto, Edcolins, John Abbe, Wmahan, Johansosa, Chowbok, Gadfium, Pgan002, Alexf, LiDaobing, Spatz, Reagle, Bk0, Vishahu, Addicted2Sanity, Deglr6328, Adashiel, Qdr, Talkstosocks, Wikismurf~enwiki, Rich Farmbrough, EliasAlucard, Treligan, Tinus, Cyclopia, Zscout370, MBisanz, PhilHibbs, RoyBoy, Femto, Stesmo, Smalljim, Clawson, Johnteslade, Giraffe-data, Congruence, Hooperbloob, Patrick Bernier, Joolz, Jeltz, Andrewpmk, Zippanova, Alinor, Uther Dhoul, Wtshymanski, Suruena, Danhash, Marcan, Pbones, H2g2bob, Pauli133, DV8 2XL, Gene Nygaard, Kay Dekker, Saxifrage, Siren-Fr, Distantbody, Mindmatrix, Professor Ninja, Lincher, JeremyA, CharlesC, Toussaint, Marudubshinki, Sherpajohn, V8rik, Rjwilmsi, Syndicate, Hulagutten, Vinodis, Fearofcarpet, Vegaswikian, SanGatiche, FlaBot, Pilchard, SchuminWeb, Weihao.chiu~enwiki, Philippe42, Kolbasz, Psoreilly, Vossman, Srieffler, Physchim62, HalifaxRage, Chobot, DVdm, UkPaolo, YurikBot, Wavelength, MMuzammils, Pburka, Tyler.szabo, Lexi Marie, Rada, Hydrargyrum, Shell Kinney, Shaddack, Rsrikanth05, Bovineone, Bboyneko, Probell, Pproctor, Chris Murphy, Lafataan, Welsh, Sncube, Johantheghost, Ndavies2, Speedevil, Maerk, Mysid, Searchme, Dan Harkless, Abune, Cassini83, Bricke~enwiki, Cnfrost, Omershahab, Sbyrnes321, Finell, NetRoller 3D, David Wahler, Locke Cole, Veinor, KnightRider~enwiki, SmackBot, Umo73, Enzymes, Thorseth, Video99, Peloneous, Kopaka649, Nil Einne, Ohnoitsjamie, Betacommand, Andy M. Wang, Bluebot, Thumperward, MalafayaBot, MIB4u, Trauph, Ihoudini, Chendy, Can't sleep, clown will eat me, Heapchk, Midnightcomm, Ghiradje, ProtocolOH, DrAvery, Smokefoot, JonathanWakely, DMacks, Blahtacular, Daniel.Cardenas, Mikastyle, SpareHeadOne, Z-d, Eliyak, Vriullop, Kuru, J. Finkelstein, Strifedaniel, F15x28, Notmicro, Twile, Mggiganteus1, Heliosphan, Hulmem, Accampbe, Nakke, Illythr, Tmd63, Ryulong, StanfordProgrammer, Sheep81, ULTRAZORD, JoeBot, T.O. Rainy Day, Andrew Hampe, IvanLanin, UncleDougge, Jim Douglas, Gatortpk, Domanix, Zarex, Dgw, CuriousEric, N2e, Yarnalgo, Bungalowbill, Erencexor, Myasuda, Elviswjr, Cydebot, Slade24, Wstaffor, Bobodod, CorpX, Myscrnm, Pvisser~enwiki, Rfscott, Dancter, Bsilver, Kozuch, Editor at Large, Trev M, Thijs!bot, NateRobinson, Robsinden, Electron9, Merbabu, Eric.frederich, NigelR, Grayshi, Iulius, Rorymanzaroli, B-80, Widefox, Alexander Kelin, Fyuncck(click), Poshzombie, Farosdaughter, Dougher, Adkatz, Jryans, JAnDbot, Mckee, TigerK 69, MER-C, Arch dude, Dp76764, JamesBWatson, Jim Douglas, Andryono, Asaa00, Morganw, Erik1974, Nucleophilic, Japo, Blackleg, LorenzoB, Clipjoint, Ac44ck, Stokestack, ChrisSerrano, An Sealgair, Vineyardglenn, Drjem3, MartinBot, Krakkers, Jim.henderson, Aladdin Sane, Rettetast, Skadetdom, CommonsDelinker, J.delanoy, Darin-0, RSRScrooge, Nigholith, Lordofthe9, Jesant13, Wikip rhyer, Eliz81, Acalamari, Lantonov, Mthibode, Ljgua124, Sigmundur, Hsr1, Squids and Chips, Cryptognome, Funandtrvl, Psamathos, VolkovBot, Jmrowland, Danbloch, Vansloot, Gene Hobbs, Philip True-man, TXiKiBot, Calwiki, Hqb, Rei-bot, IBRASS1, Anna Lincoln, Graham Wellington, Ferengi, Taltamir, Canaima, Wingedsubmariner, WinTakeAll, Arjunatgv, Sbahadur86, Lamro, Hdinstallers, Dinopardo, Brianga, Bpringlemeir, Northfox, HybridBoy, Trey, CrinklyCrunk, Fanatix, Barkeep, SieBot, MuzikJunky, Whiskey in the Jar, Yogurt6255520, Simplifier, Work permit, Weeman com, Pgd963, VVVBot, Tashnmic, Matthew Yeager, Tomatoes equal YUCK, Nopetro, EpochJ2006.5, Svick, Treekids, Martarius, ClueBot, GrandDrake, The Thing That Should Not Be, MichaelKirche, DevinCurrie, Arakunem, Mild Bill Hiccup, Boing! said Zebedee, Beauhanks, Draeath, OLED GAL, Thingg, Aitias, Rmisho, Ginbot86, Budmaster11, EdChem, InternetMeme, XLinkBot, CrunchyChevy, Chonnaowonga, SlimX, SP1R1TM4N, Smnc, MystBot, Californiarole, Colorgamut~enwiki, Terminator2029, Addbot, Wikialoft, Eptiger, Some jerk on the Internet, Jafeluv, SpellingBot, Techlady, MagnusA.Bot, AdRem, Dyadron, MrOllie, RTG, Nori.chan91, BlueOcean OceanBlue, Jandbroush, Lightbot, WikiDreamer Bot, Rojypala, Luckas-bot, Yobot, Themfromspace, Ptbogourou, Amirobot, Naipicnirp, WebAuthor, AnomieBOT, Sensible 777, Oomdotin, Floquenbeam, Daarribas, Galoubet, NeaNita, Aaagmnr, MaterialsScientist, The High Fin Sperm Whale, Citation bot, LilHelpa, Magnog, Loopykid, AbigailAbermathy, Almabot, Jaizanuvar, ComedyOfErrors, Hokkaido Ito, Doorvery far, Cristianofr, Twirligig, Transpar3nt, Kyng, Ziggymaster, FixMacs, BmckayOburn, Seshie123, Nielo-TM, Cesarvid, Michael73072, Caruso 308, Alboran, Spectatorbot13, Citation bot 1, Stellist, Visser nl, Dr-b-m, Jschnur, RedBot, TheIndianWikiEditor, MastiBot, Full-date un-linking bot, Chemexp, IJBall, Jsbeeckm, Warisstarted, DicksonDickson, Ilikeappleapple, MrX, 777sms, Lumosmaximum, Tbhocht, Darth-Sillious, RjwilmsiBot, Ripchp Bot, Phlegat, Carolynlowe, Make Our World Better, Piotrek54321, NitricAcidandTHC, TGCP, EmausBot, WikitanvirBot, Tallungs, Drm0hr, Pnjunction, Zeroatonin, Lord Rassilon 5, 68g, GoingBatty, Notonecte, Deathintime, Stanford96, Stanford96, Kokopellimama, Jdm49max, Ebrambot, H3llBot, Armbox, Hamiltha, Tanztheboss, Dirk-tooth, Johnconorryan, TechnoGeekUSA, LeonBTrotsky, Rangoon11, Dr eng x, Wakebrdkid, Rocketrod1960, ClueBot NG, Smtchahal, Birdy Numnum, Seattlema, Kurtfairfield, TruPepitoM, Twillisjr, C. Jeremy Wong, I92384, Rezbobot, GreenMachineWorld, Widr, JordoCo, Helpful Pixie Bot, Rhydic, EioE3, Olightek, Oleid, Bibcode Bot, BG19bot, Virtualerian, Cooleye101, Jon.sry, Imgaril, BBCLCD, Ssotok, Srodrig, Boesingm, Soerfm, Seamou, JamieBrown2011, Richerd andro pop, Zalexa, Vanischenu, BattyBot, Penderworth, Razzintown, Organiclighte, Cyberbot II, Shd u7, Mihaizamfiroiu, ChrisGualtieri, Soulparadox, MattPhelps29, Organiclight, Rcnorden, Gosugadget, STRONGIK7, Morrowind'sEve, Andrewms2, TheRightPerson, Themarszbar, DarkZephyr, Songanto, Dddash107, Rmalmsci100, Napy65, RonaldTimmerman, Bogdanpana, Eondax, Wyn.junior, The joke is on you chum, Lagoset, Monkbot, ChamithN, TheCoffeeAddict, Stas3098, KasparBot, Mr.dassah and Anonymous: 748
 - Solid-state lighting** *Source:* <http://en.wikipedia.org/wiki/Solid-state%20lighting?oldid=655202454> *Contributors:* Amillar, Mac, Phoebe, Bob Burton, Macrakis, Bobblewik, Fg2, Ouro, NickBell, Pmetzger, Nigelj, Cmdrjameson, Hooperbloob, Jared81, Eric Kvaalen, Atlant, Gene Nygaard, Rintojiang, Mindmatrix, TomTheHand, MiG, SDC, Wayward, Luigi2, Vegaswikian, Lmat, Srieffler, Chobot, Ytrottier, Yoninah, MrVoluntarist, Naught101, Geoffrey.landis, Darren Lee, Anthony717, SmackBot, Thorseth, Bluebot, Thumperward, Ihoudini, Rohan moore, Jacob Poon, Whpq, Soarhead77, Mion, Dogears, Jaganath, Jorgechp, TastyPoutine, Hu12, Simon12, Jac16888, Cydebot, Teratornis, Mitjaprelowsek~enwiki, Nick Number, Dawnseeker2000, MER-C, Cerrccrr, Spellmaster, Custardninja, UHF~enwiki, Oled~enwiki, Jeepday, VolkovBot, Jennymanda, Jojalozzo, Diamond Electronics, StevenDH, XLinkBot, Addbot, Ka Farag Gatri, MrOllie, KaiKemmman, Luckas-bot, Themfromspace, Weatherne, Ufim, Iluziat, Easterbeach, SSLgeek, Partyzan XXI, Angstorm, EmausBot, Seamos, Csarose, Sslsefrc, EdoBot, Jcc2011, Northamerica1000, Joshknoedler, Clovksheena, Lumenbuddha and Anonymous: 39
 - AMOLED** *Source:* <http://en.wikipedia.org/wiki/AMOLED?oldid=661785996> *Contributors:* AxelBoldt, Michael Hardy, KAMiKAZOW, Julesd, Pengo, DavidCary, Dratman, Rchandra, Wdfarmer, SidP, Vesageek, Kinema, Tbsmith, Mindmatrix, Toussaint, Miken32, V8rik, Nneonneo, Pilchard, Mithrandi, Zayani, Kedadi, Arado, Rada, Tenebrae, Nick L., Occono, Rwxrwxrwx, Pointym5, Hashashin, Coldbourne, Panoat, Ckempo, SmackBot, Anastrophe, Elk Salmon, Gilliam, Ohnoitsjamie, Thumperward, Cbrody, Hengsheng120, Simpsons contributor, Frap, Gilloq, Paulvl~enwiki, JorisvS, Courcelles, Saihariharan, Fernvale, Winston Spencer, VoxLuna, CuriousEric, N2e, RockMaster, Bungalowbill, Steel, Myscrnm, Vanished User jdksfajlasd, PizzaMan, Widefox, UzEE, Dhkkim, Magioladitis, NeverWorker,

- Crazytonyi, Erik1974, Cloudz679, DGG, HiB2Bornot2B, Jim.henderson, CommonsDelinker, Jesant13, Rod57, Supuhstar, Fxhomic, Cankoray, OlavN, Dstary, Gws898, SieBot, TJRC, Jsli, TheHoax, Nacarlon, Robbiemuffin, Spoladore, Frmorrisson, DragonBot, Random86, DerBorg, Niksko, SF007, Addbot, Mortense, C6541, Some jerk on the Internet, Darwin-rover, Faerlov, Kae, Huikaihoo, Yobot, Darx9url, AnomieBOT, GlaMax, Stewe007, Jim1138, Xqbot, Sergimasv, User931, GrouchoBot, Kyng, Mfbear, Dngnta, =Josh.Harris, FrescoBot, Louperibot, Jamouse, Galatz, Banej, Rzesor, Abc518, Trappist the monk, Diblidabliduu, Winjay, Dimitrisouza, Kpfleming, Auscompgeek, Jfmantis, RjwilmsiBot, DASHBot, Tallungs, Dewritech, Heart reaper, Halil marx07, Illegitimate Barrister, Knight717, Ο οϊστρος, Secator, TyA, Rampage Rick, Benjabean1, SBaker43, Fl4v10, Warmington, Michael Leeman, Rocketrod1960, Skhaire14, Faramarz, ClueBot NG, Gareth Griffith-Jones, Smartguy noface1990, Kojoannan, YuMaNuMa, Michael Barker, Mustafa.camurli, 573W1E, BG19bot, BBCLCD, SirKeplan, Frze, ITslick, JamieBrown2011, Ebonawit, FrankyFrank101, Zeyd tokaki 1997, Vanischenu, BattyBot, Tutelary, JahMikes, Intellectual.js, Mdann52, ChrisGualtieri, KWYJIBO16, J-FTO, MirandaStreeter, Aronhegedus, Mogism, Snjegović na Havajima, Touranushertz, Jamesx12345, Cuerex, Shriker, Norrk, PC-XT, Mezikek, Tentinator, CsizTom, Stefrance690, Comp.arch, Ajayrathore111, YiFeiBot, Sorin Mares, Athariqahamed, SonCZ, Justin.Maciel, SarahTehCat, Alfredckh, Ironose, Dagorv, Rorz112, Seattleshaw and Anonymos: 278
- **Light-emitting electrochemical cell** *Source:* <http://en.wikipedia.org/wiki/Light-emitting%20electrochemical%20cell?oldid=628878469> *Contributors:* Michael Hardy, Vegaswikian, NateRobinson, Magioladitis, Clipjoint, Squids and Chips, Addbot, Citation bot, FrescoBot, Citation bot 1, Kokopellimama, Scarmic, Wyn.junior and Anonymos: 10
 - **Electroluminescent wire** *Source:* <http://en.wikipedia.org/wiki/Electroluminescent%20wire?oldid=645930433> *Contributors:* Alan Liefiting, Eyrian, Allyn, Atlant, Woohookitty, SDC, CharlesC, SeanMack, Lmatt, Hydrargyrum, CLW, SmackBot, Thumperward, A. B., A5b, Gobonobo, Tmcw, Chetvorno, Ilikefood, Alaibot, CommonsDelinker, EdBever, KylieTastic, Funandtrvl, Hirodusk, WOSlinker, Tazameir, GlowWireGuy, IWiki2DoU, XLinkBot, Surelight, Airplaneman, Addbot, Tothwolf, Luckas-bot, Fox89, KDS4444, Buffman LT1, Materialscientist, Hadassgh, Sakitar, Balobeck, Unborn Wrath, Anon423, Louie Lights, LogiNevermore, Wormcow, L Kensington, Orange Suede Sofa, ChuispastonBot, ClueBot NG, BG19bot, Iamgingerman, Ajv39, GreatMarkO, Walnut tree, Mahmoudkaramad and Anonymos: 49
 - **Field-induced polymer electroluminescent technology** *Source:* <http://en.wikipedia.org/wiki/Field-induced%20polymer%20electroluminescent%20technology?oldid=620115185> *Contributors:* Jimfbleak, Rpyle731, Pmj, Hydrargyrum, Countakeshi, Brimba, Capmo, RomanSpa, Eastlaw, PamD, Dzubint, Funandtrvl, Joeinwap, Jacquesehuard, Addbot, Yobot, Helium4, FallingGravity, Monkbot, CJQuibble and Anonymos: 1

27.3.2 Images

- **File:02_Spiral_CFL_Bulb_2010-03-08_(black_back).jpg** *Source:* http://upload.wikimedia.org/wikipedia/commons/0/07/02_Spiral_CFL_Bulb_2010-03-08_%28black_back%29.jpg *License:* CC BY-SA 3.0 *Contributors:* Own work *Original artist:* Sun Ladder
- **File:100hgxe.jpg** *Source:* <http://upload.wikimedia.org/wikipedia/commons/8/8c/100hgxe.jpg> *License:* Public domain *Contributors:* <http://en.wikipedia.org/wiki/Image:100hgxe.jpg> *Original artist:* uploaded by Su37amelia
- **File:10ChanSeqSm.gif** *Source:* <http://upload.wikimedia.org/wikipedia/commons/c/c1/10ChanSeqSm.gif> *License:* Public domain *Contributors:* Transferred from en.wikipedia; transferred to Commons by User:Logan using CommonsHelper. *Original artist:* GlowWireGuy at en.wikipedia
- **File:10ChanSeqSmall.jpg** *Source:* <http://upload.wikimedia.org/wikipedia/commons/0/04/10ChanSeqSmall.jpg> *License:* Public domain *Contributors:* Transferred from en.wikipedia; transferred to Commons by User:Liftarn using CommonsHelper. *Original artist:* Original uploader was GlowWireGuy at en.wikipedia
- **File:150W_Magnetic_Induction_Lamp_&_Ballast.png** *Source:* http://upload.wikimedia.org/wikipedia/commons/8/87/150W_Magnetic_Induction_Lamp_%26_Ballast.png *License:* CC BY-SA 3.0 *Contributors:* Own work *Original artist:* L Michael Roberts
- **File:150_Watt_Metal_Halide.jpg** *Source:* http://upload.wikimedia.org/wikipedia/commons/8/8a/150_Watt_Metal_Halide.jpg *License:* CC-BY-SA-3.0 *Contributors:* Transferred from en.wikipedia to Commons by User:Wdwd using CommonsHelper. *Original artist:* Ozguy89 at en.wikipedia
- **File:2007-07-24_High-power_light_emitting_diodes_(Luxeon,_Lumiled).jpg** *Source:* http://upload.wikimedia.org/wikipedia/commons/2/21/2007-07-24_High-power_light_emitting_diodes_%28Luxeon%2C_Lumiled%29.jpg *License:* CC-BY-SA-3.0 *Contributors:* Own work *Original artist:* Gophi
- **File:2010-05-30_Destroyed_300W_linear_halogen_bulb.jpg** *Source:* http://upload.wikimedia.org/wikipedia/commons/9/95/2010-05-30_Destroyed_300W_linear_halogen_bulb.jpg *License:* GFDL *Contributors:* Own work *Original artist:* Ildar Sagdejev (Specious)
- **File:2014-10-31_17_48_17_Recently_activated_sodium_vapor_street_light_along_Terrace_Boulevard_in_Ewing,_New_Jersey.JPG** *Source:* http://upload.wikimedia.org/wikipedia/commons/c/c1/2014-10-31_17_48_17_Recently_activated_sodium_vapor_street_light_along_Terrace_Boulevard_in_Ewing%2C_New_Jersey.JPG *License:* CC BY-SA 4.0 *Contributors:* Own work *Original artist:* Famartin
- **File:2014-10-31_17_58_17_Recently_activated_mercury_vapor_street_light_along_Terrace_Boulevard_in_Ewing,_New_Jersey.JPG** *Source:* http://upload.wikimedia.org/wikipedia/commons/a/a4/2014-10-31_17_58_17_Recently_activated_mercury_vapor_street_light_along_Terrace_Boulevard_in_Ewing%2C_New_Jersey.JPG *License:* CC BY-SA 4.0 *Contributors:* Own work *Original artist:* Famartin
- **File:2014-10-31_23_30_00_Sodium_vapor_street_light_at_night_along_Terrace_Boulevard_in_Ewing,_New_Jersey.JPG** *Source:* http://upload.wikimedia.org/wikipedia/commons/0/00/2014-10-31_23_30_00_Sodium_vapor_street_light_at_night_along_Terrace_Boulevard_in_Ewing%2C_New_Jersey.JPG *License:* CC BY-SA 4.0 *Contributors:* Own work *Original artist:* Famartin
- **File:2014-10-31_23_40_00_Mercury_vapor_street_light_at_night_along_Terrace_Boulevard_in_Ewing,_New_Jersey.JPG** *Source:* http://upload.wikimedia.org/wikipedia/commons/6/6b/2014-10-31_23_40_00_Mercury_vapor_street_light_at_night_along_Terrace_Boulevard_in_Ewing%2C_New_Jersey.JPG *License:* CC BY-SA 4.0 *Contributors:* Own work *Original artist:* Famartin
- **File:60_LED_3W_Spot_Light_eq_25W.jpg** *Source:* http://upload.wikimedia.org/wikipedia/commons/b/b6/60_LED_3W_Spot_Light_eq_25W.jpg *License:* CC BY-SA 3.0 *Contributors:* modified http://histo.cat/1/60_LED_3W_Spot_Light_eq_25W.jpg *Original artist:* Mcapdevila

- **File:65W_SRS_fluorescent_lamp_starting.OGG** *Source:* http://upload.wikimedia.org/wikipedia/commons/9/95/65W_SRS_fluorescent_lamp_starting.OGG *License:* Public domain *Contributors:* Own work *Original artist:* ELIOT2000
- **File:AMOLED-en.svg** *Source:* <http://upload.wikimedia.org/wikipedia/commons/e/ed/AMOLED-en.svg> *License:* CC BY-SA 3.0 *Contributors:* AMOLED.png *Original artist:* AMOLED.png: www.universaldisplay.com
- **File:A_CFL_Light_Bulb_on_a_wall_in_a_black_lantern_in_South_Carolina.PNG** *Source:* http://upload.wikimedia.org/wikipedia/commons/d/d0/A_CFL_Light_Bulb_on_a_wall_in_a_black_lantern_in_South_Carolina.PNG *License:* CC BY 3.0 *Contributors:* Own work *Original artist:* IceBlade710
- **File:Air_& Space_sulfur_lamps.JPG** *Source:* http://upload.wikimedia.org/wikipedia/commons/f/f5/Air_%26_Space_sulfur_lamps.JPG *License:* Public domain *Contributors:* Transferred from en.wikipedia to Commons by User:Grunpfnul using CommonsHelper on Labs. *Original artist:* SDC at en.wikipedia
- **File:AlumQ3.png** *Source:* <http://upload.wikimedia.org/wikipedia/commons/5/52/AlumQ3.png> *License:* Public domain *Contributors:* Own work *Original artist:* Smokefoot
- **File:Ambox_current_red.svg** *Source:* http://upload.wikimedia.org/wikipedia/commons/9/98/Ambox_current_red.svg *License:* CC0 *Contributors:* self-made, inspired by Gnome globe current event.svg, using Information icon3.svg and Earth clip art.svg *Original artist:* Vipersnake151, penubag, Tkgd2007 (clock)
- **File:Ambox_globe_content.svg** *Source:* http://upload.wikimedia.org/wikipedia/commons/b/bd/Ambox_globe_content.svg *License:* Public domain *Contributors:* Own work, using File:Information icon3.svg and File:Earth clip art.svg *Original artist:* penubag
- **File:Arc_Lamp_Examples.jpg** *Source:* http://upload.wikimedia.org/wikipedia/en/9/90/Arc_Lamp_Examples.jpg *License:* PD-US *Contributors:* Scientific American
Original artist: Scientific American artists
- **File:Arc_lamp-ignition_PNr°0035.jpg** *Source:* [http://upload.wikimedia.org/wikipedia/commons/1/1a/Arc_lamp-ignition_PNr°0035.jpg](http://upload.wikimedia.org/wikipedia/commons/1/1a/Arc_lamp-ignition_PNr%C2%B00035.jpg) *License:* CC BY-SA 3.0 at *Contributors:* Own work *Original artist:* D-Kuru
- **File:Arc_light_and_battery.jpg** *Source:* http://upload.wikimedia.org/wikipedia/commons/d/da/Arc_light_and_battery.jpg *License:* Public domain *Contributors:* Retrieved September 17, 2013 from <a data-x-rel='nofollow' class='external text' href='http://books.google.com/books?id=jasLAAAYAAJ,,&,pg=PA702'>Augustin Privat Deschanel 1878 *Elementary Treatise on Natural Philosophy, Part 3: Electricity and Magnetism*, D. Appleton and Co., New York, translated by J. D. Everett, p. 702, fig. 509 on Google Books *Original artist:* Augustin Privat Deschanel
- **File:Argon_Spectrum.png** *Source:* http://upload.wikimedia.org/wikipedia/commons/3/37/Argon_Spectrum.png *License:* CC BY-SA 3.0 *Contributors:* Own work <http://goiphone5.com/> *Original artist:* Abilinin
- **File:Argon_discharge_tube.jpg** *Source:* http://upload.wikimedia.org/wikipedia/commons/8/87/Argon_discharge_tube.jpg *License:* GFDL 1.2 *Contributors:* Own work *Original artist:* Alchemist-hp (talk) (www.pse-mendelejew.de)
- **File:BCincandescentlamp.jpg** *Source:* <http://upload.wikimedia.org/wikipedia/commons/4/46/BCincandescentlamp.jpg> *License:* CC BY-SA 3.0 *Contributors:* Own work *Original artist:* Peterktan
- **File:BigBenAtDusk.jpg** *Source:* <http://upload.wikimedia.org/wikipedia/commons/8/83/BigBenAtDusk.jpg> *License:* CC BY-SA 2.0 *Contributors:* ? *Original artist:* ?
- **File:Blue_light_emitting_diodes_over_a_proto-board.jpg** *Source:* http://upload.wikimedia.org/wikipedia/commons/f/fc/Blue_light_emitting_diodes_over_a_proto-board.jpg *License:* CC BY-SA 3.0 *Contributors:* Own work *Original artist:* Gussisaurio
- **File:Br20_1.jpg** *Source:* http://upload.wikimedia.org/wikipedia/commons/6/62/Br20_1.jpg *License:* CC BY-SA 3.0 *Contributors:* Own work *Original artist:* Led-neolight
- **File:CFBulbs.jpg** *Source:* <http://upload.wikimedia.org/wikipedia/commons/3/33/CFBulbs.jpg> *License:* CC BY 2.5 *Contributors:* Self-published work by Ramjar *Original artist:* Ramjar
- **File:CFL_Positive_power.png** *Source:* http://upload.wikimedia.org/wikipedia/commons/7/7c/CFL_Positive_power.png *License:* CC BY-SA 3.0 *Contributors:* Own work *Original artist:* Wtshymanski
- **File:Carbon_Dioxide_Laser_At_The_Laser_Effects_Test_Facility.jpg** *Source:* http://upload.wikimedia.org/wikipedia/commons/e/e6/Carbon_Dioxide_Laser_At_The_Laser_Effects_Test_Facility.jpg *License:* Public domain *Contributors:* [2] *Original artist:* Unknown
- **File:Carbonfilament.jpg** *Source:* <http://upload.wikimedia.org/wikipedia/commons/2/26/Carbonfilament.jpg> *License:* CC-BY-SA-3.0 *Contributors:* Own work (own photo) *Original artist:* Ulfbaste!
- **File:Cascade-process-of-ionization.svg** *Source:* <http://upload.wikimedia.org/wikipedia/commons/c/ce/Cascade-process-of-ionization.svg> *License:* CC BY-SA 3.0 *Contributors:* Cascade process of ionization.png *Original artist:* Original png by Rudolfensis; svg version by Angelito7
- **File:Cermax2kw.jpg** *Source:* <http://upload.wikimedia.org/wikipedia/en/e/e0/Cermax2kw.jpg> *License:* PD *Contributors:* self-made
Original artist: su37amelia
- **File:Closed_double_envelope_compact_fluorescent_lamp.jpg** *Source:* http://upload.wikimedia.org/wikipedia/en/c/ce/Closed_double_envelope_compact_fluorescent_lamp.jpg *License:* CC-BY-SA-3.0 *Contributors:* I took the picture
Original artist: Bsilly

- **File:Closeup_Metal_Halide_Lamp.jpg** *Source:* http://upload.wikimedia.org/wikipedia/commons/2/2b/Closeup_Metal_Halide_Lamp.jpg *License:* Public domain *Contributors:* Transferred from en.wikipedia to Commons by User:Wdwd using CommonsHelper. *Original artist:* Dave H. Ozguy89 at en.wikipedia
- **File:Cold-Cathode-CFL-illuminated.jpg** *Source:* <http://upload.wikimedia.org/wikipedia/commons/4/40/Cold-Cathode-CFL-illuminated.jpg> *License:* CC BY-SA 3.0 *Contributors:* Own work *Original artist:* Gazebo
- **File:Cold-Cathode-CFL.jpg** *Source:* <http://upload.wikimedia.org/wikipedia/commons/b/bb/Cold-Cathode-CFL.jpg> *License:* CC BY-SA 3.0 *Contributors:* Own work *Original artist:* Gazebo
- **File:Commons-logo.svg** *Source:* <http://upload.wikimedia.org/wikipedia/en/4/4a/Commons-logo.svg> *License:* ? *Contributors:* ? *Original artist:* ?
- **File:Compact_fluorescent_lamp_wall_mounted.JPG** *Source:* http://upload.wikimedia.org/wikipedia/commons/1/11/Compact_fluorescent_lamp_wall_mounted.JPG *License:* CC BY-SA 3.0 *Contributors:* Own work *Original artist:* Prabhupuducherry
- **File:Compact_fluorescent_light_bulb_with_GU24_connector.png** *Source:* http://upload.wikimedia.org/wikipedia/commons/e/e7/Compact_fluorescent_light_bulb_with_GU24_connector.png *License:* CC BY-SA 3.0 *Contributors:* Own work *Original artist:* AndreasJS
- **File:Compact_fluorescent_light_bulbs_105W_36W_11W.jpg** *Source:* http://upload.wikimedia.org/wikipedia/commons/a/af/Compact_fluorescent_light_bulbs_105W_36W_11W.jpg *License:* CC BY-SA 3.0 *Contributors:* Own work *Original artist:* Tobias Maier
- **File:Compact_fluorescent_straight_crop.jpg** *Source:* http://upload.wikimedia.org/wikipedia/commons/2/22/Compact_fluorescent_straight_crop.jpg *License:* CC0 *Contributors:* Compact fluorescent straight.jpg *Original artist:* Nroose
- **File:Crystal_energy.svg** *Source:* http://upload.wikimedia.org/wikipedia/commons/1/14/Crystal_energy.svg *License:* LGPL *Contributors:* Own work conversion of Image:Crystal_128_energy.png *Original artist:* Dhatfield
- **File:DSC09917_BAPS_Temple_-_E_view_by_Volkan_Yuksel.jpg** *Source:* http://upload.wikimedia.org/wikipedia/commons/8/84/DSC09917_BAPS_Temple_-_E_view_by_Volkan_Yuksel.jpg *License:* CC BY-SA 3.0 *Contributors:* Own work *Original artist:* Volkan Yuksel
- **File:Dimmable_CFL.jpg** *Source:* http://upload.wikimedia.org/wikipedia/en/2/24/Dimmable_CFL.jpg *License:* CC-BY-SA-3.0 *Contributors:*
I (Black Stripe (talk)) created this work entirely by myself. *Original artist:*
Black Stripe (talk)
- **File:Diode-IV-Curve.svg** *Source:* <http://upload.wikimedia.org/wikipedia/commons/a/a5/Diode-IV-Curve.svg> *License:* CC BY-SA 3.0 *Contributors:* Roughly derived from http://en.wikipedia.org/wiki/File:Rectifier_vi_curve.GIF. Vectorization is own work. *Original artist:* H1voltage
- **File:Doutnavka.svg** *Source:* <http://upload.wikimedia.org/wikipedia/commons/b/b0/Doutnavka.svg> *License:* Public domain *Contributors:* created from scratch *Original artist:* Gargan
- **File:E27_with_38_LCD.JPG** *Source:* http://upload.wikimedia.org/wikipedia/commons/8/84/E27_with_38_LCD.JPG *License:* Public domain *Contributors:* ? *Original artist:* ?
- **File:EL_2x58ngn.jpg** *Source:* http://upload.wikimedia.org/wikipedia/commons/7/7f/EL_2x58ngn.jpg *License:* CC BY-SA 3.0 *Contributors:* Own work *Original artist:* Sympis
- **File:EL_wire.svg** *Source:* http://upload.wikimedia.org/wikipedia/commons/9/97/EL_wire.svg *License:* CC BY-SA 3.0 *Contributors:* Own work *Original artist:* LogiNevermore
- **File:EPROM_Intel_C1702A.jpg** *Source:* http://upload.wikimedia.org/wikipedia/commons/3/39/EPROM_Intel_C1702A.jpg *License:* CC-BY-SA-3.0 *Contributors:* Author personal collection. *Original artist:*
Author : Poil 01:10, 17 Apr 2005 (UTC)
- **File:Early_Cooper_Hewitt_mercury_vapor_lamp.jpg** *Source:* http://upload.wikimedia.org/wikipedia/commons/d/d1/Early_Cooper_Hewitt_mercury_vapor_lamp.jpg *License:* Public domain *Contributors:* Downloaded July 27, 2013 from <a data-x-rel="nofollow" class="external text" href="http://books.google.com/books?id=ty5RAAAAYAAJ,&&,pg=PA305">Ray Stannard Baker 1903 *Boys' Second Book of Inventions*, McClure, Phillips and Co., New York, p. 305 on Google Books *Original artist:* Unknown
- **File:Earthlights_dmsp.jpg** *Source:* http://upload.wikimedia.org/wikipedia/commons/2/21/Earthlights_dmsp.jpg *License:* Public domain *Contributors:* http://eoimages.gsfc.nasa.gov/ve//1438/land_lights_16384.tif *Original artist:* Data courtesy Marc Imhoff of NASA GSFC and Christopher Elvidge of NOAA NGDC.
- **File:EcoEnergy_EE-02-010.JPG** *Source:* http://upload.wikimedia.org/wikipedia/commons/a/ae/EcoEnergy_EE-02-010.JPG *License:* CC BY-SA 3.0 *Contributors:* Own work *Original artist:* Dmitry G
- **File:Ecran_oled_flexible.jpg** *Source:* http://upload.wikimedia.org/wikipedia/commons/1/12/Ecran_oled_flexible.jpg *License:* CC BY 2.0 *Contributors:* <http://www.flickr.com/photos/ndevil/4641264649/> *Original artist:* nDevilTV
- **File:Edison_Carbon_Bulb.jpg** *Source:* http://upload.wikimedia.org/wikipedia/commons/3/31/Edison_Carbon_Bulb.jpg *License:* CC BY 2.0 *Contributors:* Edison Light Bulb *Original artist:* Terren
- **File:Edison_incandescent_lights.jpg** *Source:* http://upload.wikimedia.org/wikipedia/commons/8/80/Edison_incandescent_lights.jpg *License:* Public domain *Contributors:* Downloaded from <a data-x-rel="nofollow" class="external text" href="http://books.google.com/books?id=r1Q3AAAAMAAJ,&&,pg=PA123">Elmer Ellsworth Burns (1910) *The Story of Great Inventions*, Harper & Brothers, New York, p.123, fig.59 on Google Books. *Original artist:* William J. Hammer
- **File:Einstein_gyro_gravity_probe_b.jpg** *Source:* http://upload.wikimedia.org/wikipedia/commons/9/9b/Einstein_gyro_gravity_probe_b.jpg *License:* Public domain *Contributors:* ? *Original artist:* ?
- **File:ElWireFuelRails.JPG** *Source:* <http://upload.wikimedia.org/wikipedia/commons/4/48/ElWireFuelRails.JPG> *License:* CC BY-SA 3.0 *Contributors:* Own work *Original artist:* Buffman LT1

- **File:Electricity_use_by_lightbulb_type.svg** *Source:* http://upload.wikimedia.org/wikipedia/commons/e/e7/Electricity_use_by_lightbulb_type.svg *License:* Public domain *Contributors:* Data taken from this revision of the en:Compact fluorescent lamp article, using average values for CFL and LED. Halogen values are from[1]. Chart created by bdesham with Gnumeric and Inkscape. *Original artist:* Benjamin D. Esham (bdesham)
- **File:Elektronstarterp.jpg** *Source:* <http://upload.wikimedia.org/wikipedia/commons/c/c4/Elektronstarterp.jpg> *License:* CC-BY-SA-3.0 *Contributors:* ? *Original artist:* ?
- **File:Elwire.jpg** *Source:* <http://upload.wikimedia.org/wikipedia/commons/4/48/Elwire.jpg> *License:* CC-BY-SA-3.0 *Contributors:* <http://en.wikipedia.org/wiki/File:Elwire.jpg> *Original artist:* Allyn
- **File:Emoji_u26a1.svg** *Source:* http://upload.wikimedia.org/wikipedia/commons/d/d0/Emoji_u26a1.svg *License:* Apache License 2.0 *Contributors:* <https://code.google.com/p/notol/> *Original artist:* Google
- **File:Energiesparlampe_01_retouched.jpg** *Source:* http://upload.wikimedia.org/wikipedia/commons/f/f9/Energiesparlampe_01_retouched.jpg *License:* CC BY-SA 3.0 *Contributors:* Own work *Original artist:* Kuebi = Armin Kübelbeck
- **File:External_Closed_Core_Induction_Lamp_with_Two_Turn_Primary.svg** *Source:* http://upload.wikimedia.org/wikipedia/commons/3/38/External_Closed_Core_Induction_Lamp_with_Two_Turn_Primary.svg *License:* CC BY-SA 4.0 *Contributors:* Own work *Original artist:* Vdroberts
- **File:Filament.jpg** *Source:* <http://upload.wikimedia.org/wikipedia/commons/0/08/Filament.jpg> *License:* Public domain *Contributors:* <https://en.wikipedia.org/w/index.php?title=File:Filament.jpg&action=edit> *Original artist:* Lander777
- **File:FirstLEDBiard1.png** *Source:* <http://upload.wikimedia.org/wikipedia/commons/d/d3/FirstLEDBiard1.png> *License:* Public domain *Contributors:* James R. Biard *Original artist:* James R. Biard
- **File:Fluo-45W_LED-17W.jpg** *Source:* http://upload.wikimedia.org/wikipedia/commons/0/03/Fluo-45W_LED-17W.jpg *License:* CC BY-SA 3.0 *Contributors:* {Modified:http://histo.cat/1/Fluo-45W_LED-17W.jpg *Original artist:* Mcapdevila
- **File:Fluorescent-lamp-electronic-ballast.webm** *Source:* <http://upload.wikimedia.org/wikipedia/commons/7/76/Fluorescent-lamp-electronic-ballast.webm> *License:* CC BY-SA 3.0 *Contributors:* Own work *Original artist:* Rmv
- **File:Fluorescent_Black-Light_spectrum_with_peaks_labelled.gif** *Source:* http://upload.wikimedia.org/wikipedia/commons/0/0a/Fluorescent_Black-Light_spectrum_with_peaks_labelled.gif *License:* Public domain *Contributors:* ? *Original artist:* ?
- **File:Fluorescent_Energy.svg** *Source:* http://upload.wikimedia.org/wikipedia/en/c/c8/Fluorescent_Energy.svg *License:* CC-BY-SA-3.0 *Contributors:*
I (Wtshymanski (talk)) created this work entirely by myself. *Original artist:* Wtshymanski (talk)
- **File:Fluorescent_Lamp_Inverter.png** *Source:* http://upload.wikimedia.org/wikipedia/commons/6/6c/Fluorescent_Lamp_Inverter.png *License:* CC-BY-SA-3.0 *Contributors:* Own work *Original artist:* Neotesla
- **File:Fluorescent_Light.svg** *Source:* http://upload.wikimedia.org/wikipedia/commons/e/e1/Fluorescent_Light.svg *License:* Public domain *Contributors:* Own work *Original artist:* Inkwina (talk · contrihs)
- **File:Fluorescent_beat_effect.ogv** *Source:* http://upload.wikimedia.org/wikipedia/commons/3/30/Fluorescent_beat_effect.ogv *License:* CC BY-SA 3.0 *Contributors:* Own work *Original artist:* Alexey Goral
- **File:Fluorescent_lamp-electronic_ballast_starter-movie_VNr°0001.ogv** *Source:* [http://upload.wikimedia.org/wikipedia/commons/b/b5/Fluorescent_lamp-electronic_ballast_starter-movie_VNr°0001.ogv](http://upload.wikimedia.org/wikipedia/commons/b/b5/Fluorescent_lamp-electronic_ballast_starter-movie_VNr%C2%B00001.ogv) *License:* CC BY-SA 3.0 *Contributors:* Own work *Original artist:* D-Kuru
- **File:Fluorescent_lamp_hold_for_T8_and_T12_lamps.jpg** *Source:* http://upload.wikimedia.org/wikipedia/commons/0/06/Fluorescent_lamp_hold_for_T8_and_T12_lamps.jpg *License:* CC BY-SA 3.0 *Contributors:* Own work *Original artist:* Dennis Brown
- **File:Fluorescent_lamp_spectrum.jpg** *Source:* http://upload.wikimedia.org/wikipedia/commons/f/f5/Fluorescent_lamp_spectrum.jpg *License:* Public domain *Contributors:* Own work *Original artist:* Reguiiee ([User_talk:Reguiiee](http://commons.wikimedia.org/w/index.php?title=User_talk:Reguiiee&action=edit&redlink=1) (page does not exist))>talk
- **File:Fluorescent_lamps_artistic.jpg** *Source:* http://upload.wikimedia.org/wikipedia/commons/5/51/Fluorescent_lamps_artistic.jpg *License:* CC BY 2.0 *Contributors:* Flickr *Original artist:* This image was originally posted to Flickr by OiMax at <http://flickr.com/photos/72396314@N00/404614118>. It was reviewed on 20 May 2007 by the FlickreviewR robot and was confirmed to be licensed under the terms of the cc-by-2.0.
- **File:Fluorescent_lighting_spectrum_peaks_labelled.svg** *Source:* http://upload.wikimedia.org/wikipedia/commons/8/8d/Fluorescent_lighting_spectrum_peaks_labelled.svg *License:* CC-BY-SA-3.0 *Contributors:*
Fluorescent_lighting_spectrum_peaks_labelled.png *Original artist:* Fluorescent_lighting_spectrum_peaks_labelled.png: en:user:Deglr6328
- **File:Fluorescent_tube_under_electric_line.jpg** *Source:* http://upload.wikimedia.org/wikipedia/commons/b/bb/Fluorescent_tube_under_electric_line.jpg *License:* CC BY-SA 3.0 *Contributors:* Own work *Original artist:* user:BaronAlaric BaronAlaric
- **File:Fluorescentfixturebelow20806.JPG** *Source:* <http://upload.wikimedia.org/wikipedia/en/a/a7/Fluorescentfixturebelow20806.JPG> *License:* PD *Contributors:* ? *Original artist:* ?
- **File:Folder_Hexagonal_Icon.svg** *Source:* http://upload.wikimedia.org/wikipedia/en/4/48/Folder_Hexagonal_Icon.svg *License:* Cc-by-sa-3.0 *Contributors:* ? *Original artist:* ?
- **File:Fused_Electrical_Filament_SEM_Stereo_500x.JPG** *Source:* http://upload.wikimedia.org/wikipedia/commons/7/73/Fused_Electrical_Filament_SEM_Stereo_500x.JPG *License:* CC BY-SA 3.0 *Contributors:* Own work *Original artist:* SecretDisc
- **File:Fused_Electrical_Filament_SEM_Stereo_50x.JPG** *Source:* http://upload.wikimedia.org/wikipedia/commons/6/63/Fused_Electrical_Filament_SEM_Stereo_50x.JPG *License:* CC BY-SA 3.0 *Contributors:* Own work *Original artist:* SecretDisc

- **File:Fused_silica_phosphorescence_from_a_24_million_watt_flash.jpg** *Source:* http://upload.wikimedia.org/wikipedia/en/a/af/Fused_silica_phosphorescence_from_a_24_million_watt_flash.jpg *License:* PD *Contributors:* I (Zaereth (talk)) created this work entirely by myself. *Original artist:* Zaereth (talk)
- **File:Galaxy_Nexus_smartphone.jpg** *Source:* http://upload.wikimedia.org/wikipedia/commons/a/ad/Galaxy_Nexus_smartphone.jpg *License:* CC BY 2.5 *Contributors:* <http://www.flickr.com/photos/laihiu/6260827340/> *Original artist:* Laihiu
- **File:Galaxy_Note_II_subpixels_representation.png** *Source:* http://upload.wikimedia.org/wikipedia/commons/5/58/Galaxy_Note_II_subpixels_representation.png *License:* CC BY-SA 3.0 *Contributors:* Galaxy Note II subpixels representation based on the image here <http://bestboyz.de/galaxy-note-2-display-hat-keine-pentile-matrix/> *Original artist:* Zayani
- **File:Garden_light_led.jpg** *Source:* http://upload.wikimedia.org/wikipedia/commons/8/8a/Garden_light_led.jpg *License:* CC BY-SA 3.0 *Contributors:* Own work *Original artist:* Timpo
- **File:Gas-discharge_lamp_Candle.jpg** *Source:* http://upload.wikimedia.org/wikipedia/commons/4/47/Gas-discharge_lamp_Candle.jpg *License:* CC BY-SA 3.0 *Contributors:* Own work *Original artist:* RaySys
- **File:Germicidal_Lamp_2.jpg** *Source:* http://upload.wikimedia.org/wikipedia/commons/7/75/Germicidal_Lamp_2.jpg *License:* CC BY-SA 2.5 *Contributors:* Own work *Original artist:* Atlant
- **File:Germicidal_UV_discharge_tube_glow.jpg** *Source:* http://upload.wikimedia.org/wikipedia/commons/8/8e/Germicidal_UV_discharge_tube_glow.jpg *License:* CC-BY-SA-3.0 *Contributors:* Own work *Original artist:* Deglr6328
- **File:Glimmlampe_spektrum.jpg** *Source:* http://upload.wikimedia.org/wikipedia/commons/c/c3/Glimmlampe_spektrum.jpg *License:* CC-BY-SA-3.0 *Contributors:* German Wikipedia, Glimmlampe_spektrum.jpg *Original artist:* de:Benutzer:Anton
- **File:Gloedelampe_fatninger.jpg** *Source:* http://upload.wikimedia.org/wikipedia/commons/2/2a/Gloedelampe_fatninger.jpg *License:* Public domain *Contributors:* Self-photographed *Original artist:* Lysmand
- **File:Glow_discharge_current-voltage_curve_English.svg** *Source:* http://upload.wikimedia.org/wikipedia/commons/5/55/Glow_discharge_current-voltage_curve_English.svg *License:* CC BY-SA 3.0 *Contributors:* Derivative of: GlowDischargeVoltAmpere.jpg *Converted to SVG format and translated captions to English. Original artist:*
- Original work: Wikigian
- **File:Gluehlampe_01_KMJ.jpg** *Source:* http://upload.wikimedia.org/wikipedia/commons/3/3a/Gluehlampe_01_KMJ.jpg *License:* CC-BY-SA-3.0 *Contributors:* de.wikipedia, original upload 26 Jun 2004 by de:Benutzer:KMJ *Original artist:* KMJ
- **File:Gluehlampe_01_KMJ.png** *Source:* http://upload.wikimedia.org/wikipedia/commons/b/b4/Gluehlampe_01_KMJ.png *License:* CC-BY-SA-3.0 *Contributors:* de.wikipedia, original upload 26. Jun 2004 by *Original artist:* KMJ, alpha masking by Edokter
- **File:HG-Spektrum_crop.jpg** *Source:* http://upload.wikimedia.org/wikipedia/commons/0/0d/HG-Spektrum_crop.jpg *License:* CC BY-SA 3.0 *Contributors:* This file was derived from: HG-Spektrum.jpg *Original artist:* Timichio at English Wikipedia
- **File:HLR-OSRAM-3KW-A.jpg** *Source:* <http://upload.wikimedia.org/wikipedia/commons/c/cf/HLR-OSRAM-3KW-A.jpg> *License:* CC BY-SA 2.5 *Contributors:* own work by Hyperlight <http://en.wikipedia.org/wiki/Image:HLR-OSRAM-3KW-A.jpg> *Original artist:* Hyperlight
- **File:HLR-SHORT-ARC-SUPPLY-B.jpg** *Source:* <http://upload.wikimedia.org/wikipedia/commons/7/70/HLR-SHORT-ARC-SUPPLY-B.jpg> *License:* CC BY-SA 2.5 *Contributors:* own work by Hyperlight <http://en.wikipedia.org/wiki/Image:HLR-GE-1KW-LAMPHOUSE-A.jpg> *Original artist:* Hyperlight
- **File:HMI_end_of_life.JPG** *Source:* http://upload.wikimedia.org/wikipedia/commons/a/a8/HMI_end_of_life.JPG *License:* CC BY-SA 3.0 *Contributors:* Own work *Original artist:* Dmitry G
- **File:HMI_searchlight_in_Kose.JPG** *Source:* http://upload.wikimedia.org/wikipedia/commons/2/25/HMI_searchlight_in_Kose.JPG *License:* Public domain *Contributors:* Own work *Original artist:* Dmitry G
- **File:HPS-lamps.jpg** *Source:* <http://upload.wikimedia.org/wikipedia/commons/8/85/HPS-lamps.jpg> *License:* CC-BY-SA-3.0 *Contributors:* en.wikipedia *Original artist:* Klaas
- **File:Haitz_law.svg** *Source:* http://upload.wikimedia.org/wikipedia/commons/c/c0/Haitz_law.svg *License:* CC BY-SA 3.0 *Contributors:* Own work *Original artist:* Thorseth
- **File:HallThruster_2.jpg** *Source:* http://upload.wikimedia.org/wikipedia/commons/4/4f/HallThruster_2.jpg *License:* Public domain *Contributors:* Transferred from en.wikipedia to Commons. *Original artist:* Dstaack at English Wikipedia
- **File:Halogen-bulb-3.jpg** *Source:* <http://upload.wikimedia.org/wikipedia/commons/d/df/Halogen-bulb-3.jpg> *License:* CC BY-SA 2.5 *Contributors:* <http://en.wikipedia.org/wiki/Image:Halogen-bulb.jpg> *Original artist:* Modified from a photo by Stefan Wernli
- **File:Halogen.jpg** *Source:* <http://upload.wikimedia.org/wikipedia/commons/b/ba/Halogen.jpg> *License:* CC-BY-SA-3.0 *Contributors:* ? *Original artist:* ?
- **File:Halogen_lamp_operating.jpg** *Source:* http://upload.wikimedia.org/wikipedia/commons/c/c8/Halogen_lamp_operating.jpg *License:* Public domain *Contributors:* Own work *Original artist:* CoolKoon
- **File:Halogen_spectrum.svg** *Source:* http://upload.wikimedia.org/wikipedia/commons/c/cc/Halogen_spectrum.svg *License:* Public domain *Contributors:* <http://www.mtholyoke.edu/~{ }mpeterso/classes/phys301/projects2001/awgachor/awgachor.htm> *Original artist:* Mark A. Peterson, professor of physics, Mt. Holyoke University
- **File:Halogenlight.JPG** *Source:* <http://upload.wikimedia.org/wikipedia/commons/9/98/Halogenlight.JPG> *License:* CC BY-SA 3.0 *Contributors:* Own work *Original artist:* Hanabishi
- **File:Hauksbee_Generator.JPG** *Source:* http://upload.wikimedia.org/wikipedia/commons/b/b6/Hauksbee_Generator.JPG *License:* Public domain *Contributors:* ? *Original artist:* ?

- **File:Helical_fluorescent_lamp_spectrum_by_diffraction_grating.JPG** *Source:* http://upload.wikimedia.org/wikipedia/commons/2/22/Helical_fluorescent_lamp_spectrum_by_diffraction_grating.JPG *License:* CC BY-SA 4.0 *Contributors:* Own work *Original artist:* Zaereth
- **File:Helical_fluorescent_lamp_thermal_image.jpg** *Source:* http://upload.wikimedia.org/wikipedia/commons/1/13/Helical_fluorescent_lamp_thermal_image.jpg *License:* CC0 *Contributors:* Own work *Original artist:* Zaereth
- **File:Helium_discharge_tube.jpg** *Source:* http://upload.wikimedia.org/wikipedia/commons/8/82/Helium_discharge_tube.jpg *License:* GFDL 1.2 *Contributors:* Own work *Original artist:* Alchemist-hp ([User talk:Alchemist-hp](http://commons.wikimedia.org/wiki/User_talk:Alchemist-hp)) (www.pse-mendeleejew.de)
- **File:Helium_spectra.jpg** *Source:* http://upload.wikimedia.org/wikipedia/commons/c/c3/Helium_spectra.jpg *License:* Public domain *Contributors:* Transferred from en.wikipedia; transferred to Commons by User:João Sousa using CommonsHelper. *Original artist:* (teravolt (talk)). Original uploader was Teravolt at en.wikipedia
- **File:Hglamp1.jpg** *Source:* <http://upload.wikimedia.org/wikipedia/commons/9/95/Hglamp1.jpg> *License:* CC BY-SA 3.0 *Contributors:* Own work (Original text: *I created this work entirely by myself.*) *Original artist:* Materialschemist (talk)
- **File:High_Pressure_Sodium_Lamp_Spectrum.jpg** *Source:* http://upload.wikimedia.org/wikipedia/commons/c/cb/High_Pressure_Sodium_Lamp_Spectrum.jpg *License:* CC BY-SA 3.0 *Contributors:* Transferred from en.wikipedia to Commons by User:Wdwd using CommonsHelper. *Original artist:* L. Michael Roberts (LMRoberts at en.wikipedia)
- **File:High_pressure_sodium_lamp.svg** *Source:* http://upload.wikimedia.org/wikipedia/commons/4/44/High_pressure_sodium_lamp.svg *License:* CC-BY-SA-3.0 *Contributors:* Created in Adobe Illustrator CS2 based on en:Image:HPSLamp.png *Original artist:* Sakurambo at en.wikipedia
- **File:Hill_AFB_hangar_sulfur_lamps.JPG** *Source:* http://upload.wikimedia.org/wikipedia/commons/6/63/Hill_AFB_hangar_sulfur_lamps.JPG *License:* Public domain *Contributors:* U.S. Department of Energy *Original artist:* U.S. Department of Energy
- **File:Hydrogen_Spectra.jpg** *Source:* http://upload.wikimedia.org/wikipedia/commons/e/e4/Hydrogen_Spectra.jpg *License:* Public domain *Contributors:* Own work (Teravolt) *Original artist:* Teravolt at en.wikipedia
- **File:Hydrogen_discharge_tube.jpg** *Source:* http://upload.wikimedia.org/wikipedia/commons/8/83/Hydrogen_discharge_tube.jpg *License:* FAL *Contributors:* Own work *Original artist:* Alchemist-hp ([User talk:Alchemist-hp](http://commons.wikimedia.org/wiki/User_talk:Alchemist-hp)) (www.pse-mendeleejew.de)
- **File:Incandescent_bulb_shapes.svg** *Source:* http://upload.wikimedia.org/wikipedia/en/c/c8/Incandescent_bulb_shapes.svg *License:* CC-BY-SA-3.0 *Contributors:* Created with iDraw on Mac. *Original artist:* Woodega
- **File:Incandescent_light_bulb.svg** *Source:* http://upload.wikimedia.org/wikipedia/commons/6/62/Incandescent_light_bulb.svg *License:* Public domain *Contributors:* This vector image was created with Inkscape. *Original artist:* Created by User:Fastfission in Inkscape.
- **File:Internal_Inductor-type_Induction_Lamp.svg** *Source:* http://upload.wikimedia.org/wikipedia/commons/4/49/Internal_Inductor-type_Induction_Lamp.svg *License:* GFDL *Contributors:* 100 *Original artist:* Fred the Oyster
- **File:Ion_spectral_line_radiation_from_a_krypton_arc_lamp.JPG** *Source:* http://upload.wikimedia.org/wikipedia/commons/f/f7/Ion_spectral_line_radiation_from_a_krypton_arc_lamp.JPG *License:* Public domain *Contributors:* Own work *Original artist:* Zaereth (talk)
- **File:Ir(mppy)3.png** *Source:* <http://upload.wikimedia.org/wikipedia/commons/c/c0/Ir%28mppy%293.png> *License:* Public domain *Contributors:* Own work (Original text: *I created this work entirely by myself.*) *Original artist:* Nergaal (talk)
- **File:Joseph_Wilson_Swan.jpg** *Source:* http://upload.wikimedia.org/wikipedia/commons/7/7c/Joseph_Wilson_Swan.jpg *License:* Public domain *Contributors:* Transferred from en.wikipedia to Commons by frisko. *Original artist:* The original uploader was Maximus Rex at English Wikipedia
- **File:Kelvin_Temperature_Chart.svg** *Source:* http://upload.wikimedia.org/wikipedia/commons/c/cc/Kelvin_Temperature_Chart.svg *License:* CC BY-SA 3.0 *Contributors:* Kelvin_Temperature_Chart.jpg *Original artist:* Kelvin_Temperature_Chart.jpg: Mifsud26
- **File:Kompaktleuchtstofflampe.jpeg** *Source:* <http://upload.wikimedia.org/wikipedia/commons/3/32/Kompaktleuchtstofflampe.jpeg> *License:* CC-BY-SA-3.0 *Contributors:* ? *Original artist:* ?
- **File:Krypton_Spectrum.jpg** *Source:* http://upload.wikimedia.org/wikipedia/commons/a/a6/Krypton_Spectrum.jpg *License:* Public domain *Contributors:* en wikipedia ([1]) *Original artist:* Mrgoogfan
- **File:Krypton_arc_lamp_and_a_xenon_flashlamp.JPG** *Source:* http://upload.wikimedia.org/wikipedia/en/f/fa/Krypton_arc_lamp_and_a_xenon_flashlamp.JPG *License:* PD *Contributors:* I (Zaereth (talk)) created this work entirely by myself. *Original artist:* Zaereth (talk)
- **File:Krypton_discharge_tube.jpg** *Source:* http://upload.wikimedia.org/wikipedia/commons/5/50/Krypton_discharge_tube.jpg *License:* GFDL 1.2 *Contributors:* Own work *Original artist:* Alchemist-hp ([User talk:Alchemist-hp](http://commons.wikimedia.org/wiki/User_talk:Alchemist-hp)) (www.pse-mendeleejew.de)
- **File:LAjaHID.jpg** *Source:* <http://upload.wikimedia.org/wikipedia/commons/8/80/LAjaHID.jpg> *License:* CC BY 3.0 *Contributors:* Own work *Original artist:* Sympпис
- **File:LED_5mm_green_(en).svg** *Source:* http://upload.wikimedia.org/wikipedia/commons/f/f9/LED%2C_5mm%2C_green_%28en%29.svg *License:* Public domain *Contributors:* Own work by uploader, drawn in Solid Edge and Inkscape. *Original artist:* Inductiveload

- **File:LED-chip-20-deg-crti-angle_-_both_types_-_crop.png** Source: http://upload.wikimedia.org/wikipedia/commons/d/d4/LED-chip-20-deg-crti-angle_-_both_types_-_crop.png License: CC BY 3.0 Contributors: Own work Original artist: DMahalko, Dale Mahalko, Gilman, WI, USA -- Email: dmahalko@gmail.com
- **File:LED-flickering.JPG** Source: <http://upload.wikimedia.org/wikipedia/commons/6/60/LED-flickering.JPG> License: Public domain Contributors: Own work Original artist: Dmitry G
- **File:LEDClose6545.jpg** Source: <http://upload.wikimedia.org/wikipedia/en/1/13/LEDClose6545.jpg> License: CC-BY-SA-3.0 Contributors: Recording an equipment change
Previously published: none
Original artist: Edgy01
- **File:LED_Costume_by_Beo_Beyond.jpg** Source: http://upload.wikimedia.org/wikipedia/commons/e/ee/LED_Costume_by_Beo_Beyond.jpg License: CC BY 3.0 Contributors: Own work Original artist: Beo Beyond
- **File:LED_E27_corn.JPG** Source: http://upload.wikimedia.org/wikipedia/commons/c/cd/LED_E27_corn.JPG License: CC BY-SA 3.0 Contributors: Own work Original artist: Dmitry G
- **File:LED_T-bar_ceiling_light.JPG** Source: http://upload.wikimedia.org/wikipedia/commons/6/69/LED_T-bar_ceiling_light.JPG License: CC BY 3.0 Contributors: Own work Original artist: Rintojiang
- **File:LED_bulbs.jpg** Source: http://upload.wikimedia.org/wikipedia/commons/7/76/LED_bulbs.jpg License: CC BY 3.0 Contributors: Transferred from en.wikipedia; transferred to Commons by User:Liftarn using CommonsHelper. Original artist: Original uploader was Geoffrey.landis at en.wikipedia
- **File:LED_bulbs_2012.jpg** Source: http://upload.wikimedia.org/wikipedia/en/6/67/LED_bulbs_2012.jpg License: CC-BY-3.0 Contributors: ? Original artist: ?
- **File:LED_for_mines.jpg** Source: http://upload.wikimedia.org/wikipedia/commons/7/74/LED_for_mines.jpg License: Public domain Contributors: <http://www.flickr.com/photos/niosh/8869222704/> Original artist: National Institute for Occupational Safety and Health
- **File:LED_light_emission_cones_from_2D_plane_emission_zone.png** Source: http://upload.wikimedia.org/wikipedia/commons/6/62/LED_light_emission_cones_from_2D_plane_emission_zone.png License: CC BY 3.0 Contributors: Own work Original artist: DMahalko, Dale Mahalko, Gilman, WI, USA -- Email: dmahalko@gmail.com
- **File:LED_symbol.svg** Source: http://upload.wikimedia.org/wikipedia/commons/e/e5/LED_symbol.svg License: CC BY-SA 3.0 Contributors: ? Original artist: ?
- **File:LGLED, LED, 55LED, 3D_OLED_TV_LED(2).jpg** Source: [http://upload.wikimedia.org/wikipedia/commons/3/3c/LGLED, LED, 55LED, 3D_OLED_TV_LED\(2\).jpg](http://upload.wikimedia.org/wikipedia/commons/3/3c/LGLED, LED, 55LED, 3D_OLED_TV_LED(2).jpg) License: CC BY 2.0 Contributors: LGLED, LED, 55LED 3D OLED TV LED Original artist: LGLED
- **File:LPS_Lamp_35W.jpg** Source: http://upload.wikimedia.org/wikipedia/commons/e/e7/LPS_Lamp_35W.jpg License: Public domain Contributors: Own work Original artist: Proton02
- **File:LPS_Lamp_35W_running.jpg** Source: http://upload.wikimedia.org/wikipedia/commons/0/0d/LPS_Lamp_35W_running.jpg License: Public domain Contributors: Own work Original artist: Proton02
- **File:LampSymbol.png** Source: <http://upload.wikimedia.org/wikipedia/en/c/c7/LampSymbol.png> License: CC-BY-3.0 Contributors: ? Original artist: ?
- **File:Lamp_symbol_old.svg** Source: http://upload.wikimedia.org/wikipedia/commons/b/b2/Lamp_symbol%2C_old.svg License: CC-BY-SA-3.0 Contributors: ? Original artist: ?
- **File:Lamp_symbol.svg** Source: http://upload.wikimedia.org/wikipedia/commons/4/4d/Lamp_symbol.svg License: CC-BY-SA-3.0 Contributors: ? Original artist: ?
- **File:Lampa_siarkowa.jpg** Source: http://upload.wikimedia.org/wikipedia/commons/2/20/Lampa_siarkowa.jpg License: CC-BY-SA-3.0 Contributors: Transferred from pl.wikipedia to Commons by Masur using CommonsHelper. Original artist: Ejcum at Polish Wikipedia
- **File:Lampe_LED_G24.jpg** Source: http://upload.wikimedia.org/wikipedia/commons/3/3a/Lampe_LED_G24.jpg License: CC BY-SA 3.0 Contributors: Own work Original artist: Eglou56
- **File:Lampe_a_vapeur_de_sodium.jpg** Source: http://upload.wikimedia.org/wikipedia/commons/8/81/Lampe_a_vapeur_de_sodium.jpg License: Public domain Contributors: Transferred from en.wikipedia Original artist: Skatebiker at en.wikipedia
- **File:Lampe_à_induction.jpg** Source: http://upload.wikimedia.org/wikipedia/commons/c/c2/Lampe_%C3%A0_induction.jpg License: Public domain Contributors: Own work Original artist: Sabinezhangwang
- **File:Lelightbulbs.jpg** Source: <http://upload.wikimedia.org/wikipedia/commons/4/49/Lelightbulbs.jpg> License: CC BY-SA 3.0 Contributors: Own work Original artist: Aleman89
- **File:Leuchtstofflampen-ctaube050409.jpg** Source: <http://upload.wikimedia.org/wikipedia/commons/5/5b/Leuchtstofflampen-ctaube050409.jpg> License: CC BY-SA 2.0 de Contributors: Own work Original artist: Created by Christian Taube, white balance fixed by Deglr6328
- **File:Lichtbogen_3000_Volt.jpg** Source: http://upload.wikimedia.org/wikipedia/commons/f/f8/Lichtbogen_3000_Volt.jpg License: CC BY 3.0 Contributors: Own work Original artist: Achim Grochowski -- Achgro
- **File:Light-Bulb-Filament-engineerguy.ogv** Source: <http://upload.wikimedia.org/wikipedia/commons/1/14/Light-Bulb-Filament-engineerguy.ogv> License: CC BY-SA 3.0 Contributors: <http://www.engineerguy.com/videos.htm> Original artist: Bill Hammack
- **File:Light_Emitting_Polymer_display_partially_failed.jpg** Source: http://upload.wikimedia.org/wikipedia/commons/d/d2/Light_Emitting_Polymer_display_partially_failed.jpg License: Public domain Contributors: http://en.wikipedia.org/wiki/Image:Lep_partfail.jpg Original artist: Colin99

- **File:Light_bulb.png** *Source:* http://upload.wikimedia.org/wikipedia/commons/0/06/Light_bulb.png *License:* Public domain *Contributors:* english wikipedia, original upload 14 November 2004 by en>User:Berku *Original artist:* Thomas Edison
- **File:Lightning3.jpg** *Source:* <http://upload.wikimedia.org/wikipedia/commons/4/4b/Lightning3.jpg> *License:* Public domain *Contributors:* United States Air Force, VIRIN 040304-F-0000S-002 (and VIRIN 060822-F-1111A-001) *Original artist:* U.S. Air Force photo by Edward Aspera Jr.
- **File:Lightning_over_Oradea_Romania_3.jpg** *Source:* http://upload.wikimedia.org/wikipedia/commons/1/13/Lightning_over_Oradea_Romania_3.jpg *License:* Public domain *Contributors:* Edited version of Image:Lightning over Oradea Romania 2.jpg. *Original artist:* Mircea Madau
- **File:Livermore_Centennial_Light_Bulb.jpg** *Source:* http://upload.wikimedia.org/wikipedia/commons/a/a1/Livermore_Centennial_Light_Bulb.jpg *License:* CC0 *Contributors:* Own work *Original artist:* LPS.1
- **File:MV_Lamp_175_W.JPG** *Source:* http://upload.wikimedia.org/wikipedia/commons/0/04/MV_Lamp_175_W.JPG *License:* Public domain *Contributors:* Own work *Original artist:* Tylercat5 (talk)
- **File:Magnetek_Watt_Reducer_HPF_Rapid_Start_Ballast.jpg** *Source:* http://upload.wikimedia.org/wikipedia/commons/7/72/Magnetek_Watt_Reducer_HPF_Rapid_Start_Ballast.jpg *License:* Public domain *Contributors:* Own work *Original artist:* Bamasamma1003
- **File:Magnetic_ropes.svg** *Source:* http://upload.wikimedia.org/wikipedia/commons/1/12/Magnetic_ropes.svg *License:* Public domain *Contributors:* <http://history.nasa.gov/SP-345/ch15.htm#250> *Original artist:* NASA; edited by Jaybear
- **File:Medical_arc_lamp.jpg** *Source:* http://upload.wikimedia.org/wikipedia/commons/3/3b/Medical_arc_lamp.jpg *License:* Public domain *Contributors:* Retrieved April 19, 2013 from <a data-x-rel="nofollow" class="external text" href="http://books.google.com/books?id=y3loAAAAyAAJ.&,..pg=PA86">Herbert McIntosh 1909 *Practical Handbook of Medical Electricity*, Therapeutic Publishing Co., Boston, USA, p. 86, fig. 51 on Google Books *Original artist:* Herbert McIntosh
- **File:MercuryVaporLamp.jpg** *Source:* <http://upload.wikimedia.org/wikipedia/commons/3/3c/MercuryVaporLamp.jpg> *License:* Public domain *Contributors:* own work by Torindkft
English Wikipedia: <http://en.wikipedia.org/wiki/Image:MercuryVaporLamp.jpg> *Original artist:* Torindkft
- **File:Mercury_Spectra.jpg** *Source:* http://upload.wikimedia.org/wikipedia/commons/2/29/Mercury_Spectra.jpg *License:* Public domain *Contributors:* Own work (Original caption: “I (teravolt (talk)) created this work entirely by myself.”) *Original artist:* (teravolt (talk)) / Teravolt at en.wikipedia
- **File:Mercury_discharge_tube.jpg** *Source:* http://upload.wikimedia.org/wikipedia/commons/9/95/Mercury_discharge_tube.jpg *License:* Public domain *Contributors:* Own work *Original artist:* Alchemist-hp (talk) (www.pse-mendeleejew.de)
- **File:Mercury_emissions_by_light_source_EPA_2008.svg** *Source:* http://upload.wikimedia.org/wikipedia/en/3/3a/Mercury_emissions_by_light_source_EPA_2008.svg *License:* CC-BY-SA-3.0 *Contributors:* Updated Mercury emissions by light source (en).svg with July 2008 EPA data from [1] *Original artist:* W. T. Shymanski updating the file by Benjamin D. Esham for the Wikimedia Commons.
- **File:Mercury_vapor_lamp_125_watts.jpg** *Source:* http://upload.wikimedia.org/wikipedia/commons/e/e8/Mercury_vapor_lamp_125_watts.jpg *License:* CC BY-SA 3.0 *Contributors:* Own work *Original artist:* Kukdide
- **File:Mercury_vapour_lamp.ogg** *Source:* http://upload.wikimedia.org/wikipedia/commons/b/b6/Mercury_vapour_lamp.ogg *License:* Public domain *Contributors:* Own work *Original artist:* ELIOT2000
- **File:Merge-arrows.svg** *Source:* <http://upload.wikimedia.org/wikipedia/commons/5/52/Merge-arrows.svg> *License:* Public domain *Contributors:* ? *Original artist:* ?
- **File:Mergefrom.svg** *Source:* <http://upload.wikimedia.org/wikipedia/commons/0/0f/Mergefrom.svg> *License:* Public domain *Contributors:* ? *Original artist:* ?
- **File:Metaalhalidelamp.JPG** *Source:* <http://upload.wikimedia.org/wikipedia/commons/1/17/Metaalhalidelamp.JPG> *License:* CC-BY-SA-3.0 *Contributors:* Transferred from nl.wikipedia to Commons. *Original artist:* Gerben49 at Dutch Wikipedia
- **File:Metal-Halide_lamp_70_Watt_screw_fixture.jpg** *Source:* http://upload.wikimedia.org/wikipedia/commons/8/8d/Metal-Halide_lamp_70_Watt_screw_fixture.jpg *License:* CC BY 3.0 *Contributors:* Own work *Original artist:* Jmak
- **File:MetalHalideHighBay.jpg** *Source:* <http://upload.wikimedia.org/wikipedia/commons/5/5a/MetalHalideHighBay.jpg> *License:* Public domain *Contributors:* Transferred from en.wikipedia to Commons by User:Wdwd using CommonsHelper. *Original artist:* Ozguy89 at en.wikipedia
- **File:Metal_Halide_Lamp_Spectrum.jpg** *Source:* http://upload.wikimedia.org/wikipedia/en/9/93/Metal_Halide_Lamp_Spectrum.jpg *License:* CC-BY-3.0 *Contributors:* I (L. Michael Roberts) created this work entirely by myself.
Original artist:
L. Michael Roberts
- **File:Metal_halide_warming_up.JPG** *Source:* http://upload.wikimedia.org/wikipedia/commons/a/a3/Metal_halide_warming_up.JPG *License:* CC BY-SA 3.0 *Contributors:* Own work *Original artist:* JoeX
- **File:Mhlightsbaseball.JPG** *Source:* <http://upload.wikimedia.org/wikipedia/commons/6/61/Mhlightsbaseball.JPG> *License:* Public domain *Contributors:* Transferred from en.wikipedia to Commons by User:Wdwd using CommonsHelper. *Original artist:* Mg rotc2487 at en.wikipedia
- **File:Microflash-quartz-phosphorescence.jpg** *Source:* <http://upload.wikimedia.org/wikipedia/commons/c/cc/Microflash-quartz-phosphorescence.jpg> *License:* CC BY-SA 3.0 *Contributors:* Own work *Original artist:* Niels Noordhoek
- **File:Microscope_MercuryArcBulb_Detail.jpg** *Source:* http://upload.wikimedia.org/wikipedia/commons/2/2b/Microscope_MercuryArcBulb_Detail.jpg *License:* CC BY-SA 3.0 *Contributors:* Own work *Original artist:* Zephyrus

- **File:Monks'{}_cellarium,_Fountains_Abbey.jpg** *Source:* http://upload.wikimedia.org/wikipedia/commons/2/29/Monks%27_cellarium%2C_Fountains_Abbey.jpg *License:* CC BY-SA 4.0 *Contributors:* Own work *Original artist:* Katie Chan
- **File:Muzeum_Narodowe_w_Warszawie_Galeria_Sztuki_XIX_wieku.JPG** *Source:* http://upload.wikimedia.org/wikipedia/commons/b/be/Muzeum_Narodowe_w_Warszawie_Galeria_Sztuki_XIX_wieku.JPG *License:* CC BY-SA 3.0 pl *Contributors:* Own work *Original artist:* Adrian Grycuk
- **File:NE-34_LAMP.JPG** *Source:* http://upload.wikimedia.org/wikipedia/commons/c/c9/NE-34_LAMP.JPG *License:* CC BY 3.0 *Contributors:* Transferred from en.wikipedia; transferred to Commons by User:Wdwd using CommonsHelper. *Original artist:* Teravolt (talk). Original uploader was Teravolt at en.wikipedia
- **File:NE2COLORED.JPG** *Source:* <http://upload.wikimedia.org/wikipedia/commons/7/7d/NE2COLORED.JPG> *License:* CC0 *Contributors:* Own work *Original artist:* Gavryuha
- **File:NeTube.jpg** *Source:* <http://upload.wikimedia.org/wikipedia/commons/8/88/NeTube.jpg> *License:* CC BY-SA 2.5 *Contributors:* user-made *Original artist:* User:Pslawinski
- **File:Neon_discharge_tube.jpg** *Source:* http://upload.wikimedia.org/wikipedia/commons/4/46/Neon_discharge_tube.jpg *License:* GFDL 1.2 *Contributors:* Own work *Original artist:* Alchemist-hp (talk) (www.pse-mendeleejew.de)
- **File:Neon_spectra.jpg** *Source:* http://upload.wikimedia.org/wikipedia/commons/9/99/Neon_spectra.jpg *License:* Public domain *Contributors:* Transferred from en.wikipedia *Original artist:* Teravolt at en.wikipedia
- **File:Neonlamp3.JPG** *Source:* <http://upload.wikimedia.org/wikipedia/commons/5/5e/Neonlamp3.JPG> *License:* CC BY-SA 3.0 *Contributors:* Own work *Original artist:* Ceinturion 17:47, 19 August 2007 (UTC)
- **File:New_GE_Ballast.JPG** *Source:* http://upload.wikimedia.org/wikipedia/commons/0/0a/New_GE_Ballast.JPG *License:* Public domain *Contributors:* Own work *Original artist:* Dmitry G
- **File:New_torch_bulb.jpg** *Source:* http://upload.wikimedia.org/wikipedia/commons/7/76/New_torch_bulb.jpg *License:* Public domain *Contributors:* ? *Original artist:* ?
- **File:Nexus_one_screen_microscope.jpg** *Source:* http://upload.wikimedia.org/wikipedia/commons/8/89/Nexus_one_screen_microscope.jpg *License:* CC BY 3.0 *Contributors:* Transferred from en.wikipedia; transferred to Commons by User:Wdwd using CommonsHelper. *Original artist:* Original uploader was Matthew Rollings at en.wikipedia
- **File:Night-Game.jpg** *Source:* <http://upload.wikimedia.org/wikipedia/commons/9/9c/Night-Game.jpg> *License:* CC-BY-SA-3.0 *Contributors:* ? *Original artist:* ?
- **File:Nitrogen_Spectra.jpg** *Source:* http://upload.wikimedia.org/wikipedia/commons/3/37/Nitrogen_Spectra.jpg *License:* Public domain *Contributors:* Transferred from en.wikipedia; transferred to Commons by User:João Sousa using CommonsHelper. *Original artist:* (teravolt (talk)). Original uploader was Teravolt at en.wikipedia
- **File:Nitrogen_discharge_tube.jpg** *Source:* http://upload.wikimedia.org/wikipedia/commons/9/98/Nitrogen_discharge_tube.jpg *License:* FAL *Contributors:* Own work *Original artist:* Alchemist-hp (talk) (www.pse-mendeleejew.de)
- **File:Nixie2.gif** *Source:* <http://upload.wikimedia.org/wikipedia/commons/4/4f/Nixie2.gif> *License:* CC BY-SA 3.0 *Contributors:* Own work *Original artist:* Hellbus
- **File:Nuvola_apps_ksim.png** *Source:* http://upload.wikimedia.org/wikipedia/commons/8/8d/Nuvola_apps_ksim.png *License:* LGPL *Contributors:* <http://icon-king.com> *Original artist:* David Vignoni / ICON KING
- **File:OEL_right.JPG** *Source:* http://upload.wikimedia.org/wikipedia/commons/0/0b/OEL_right.JPG *License:* CC BY-SA 3.0 *Contributors:* Own work *Original artist:* STRONGlk7
- **File:OLEDScreen.jpg** *Source:* <http://upload.wikimedia.org/wikipedia/commons/d/d7/OLEDScreen.jpg> *License:* CC-BY-SA-3.0 *Contributors:* <http://en.wikipedia.org/wiki/Image:OLEDScreen.jpg> *Original artist:* en:user:Yogurt6255520
- **File:OLED_EarlyProduct.JPG** *Source:* http://upload.wikimedia.org/wikipedia/commons/f/f2/OLED_EarlyProduct.JPG *License:* CC-BY-SA-3.0 *Contributors:* English Wiki *Original artist:* meharris
- **File:OLED_schematic.svg** *Source:* http://upload.wikimedia.org/wikipedia/commons/a/a9/OLED_schematic.svg *License:* CC-BY-SA-3.0 *Contributors:* own image *Original artist:* Rafał Konieczny
- **File:Old_USSR_Ballast.JPG** *Source:* http://upload.wikimedia.org/wikipedia/commons/c/c6/Old_USSR_Ballast.JPG *License:* Public domain *Contributors:* Own work (Own photo) *Original artist:* Dmitry G
- **File:Oled_display_alterung.jpg** *Source:* http://upload.wikimedia.org/wikipedia/commons/4/42/Oled_display_alterung.jpg *License:* Public domain *Contributors:* http://de.wikipedia.org/wiki/Bild:Oled_display_alterung.jpg *Original artist:* Badpeon
- **File:Orange_LED_emitting.png** *Source:* http://upload.wikimedia.org/wikipedia/commons/0/06/Orange_LED_emitting.png *License:* CC BY-SA 3.0 *Contributors:* Own work *Original artist:* Eeppliteloop
- **File:Osram_POWERTRONIC_PTi_35.JPG** *Source:* http://upload.wikimedia.org/wikipedia/commons/1/1d/Osram_POWERTRONIC_PTi_35.JPG *License:* CC BY-SA 3.0 *Contributors:* Own work *Original artist:* Dmitry G
- **File:Osramspectrum.png** *Source:* <http://upload.wikimedia.org/wikipedia/commons/1/1f/Osramspectrum.png> *License:* CC0 *Contributors:* Own work *Original artist:* Dr J.D.Good
- **File:Oxygen_discharge_tube.jpg** *Source:* http://upload.wikimedia.org/wikipedia/commons/4/45/Oxygen_discharge_tube.jpg *License:* FAL *Contributors:* Own work *Original artist:* Alchemist-hp (talk) (www.pse-mendeleejew.de)
- **File:Oxygen_spectre.jpg** *Source:* http://upload.wikimedia.org/wikipedia/commons/a/a0/Oxygen_spectre.jpg *License:* Public domain *Contributors:* English Wikipedia (deleted) *Original artist:* Teravolt

- **File:Peter_Cooper_Hewitt.jpg** *Source:* http://upload.wikimedia.org/wikipedia/commons/b/b2/Peter_Cooper_Hewitt.jpg *License:* Public domain *Contributors:* This image is available from the United States Library of Congress's Prints and Photographs division under the digital ID cph.3c20859.
This tag does not indicate the copyright status of the attached work. A normal copyright tag is still required. See Commons:Licensing for more information. *Original artist:* Bain News Service photograph
- **File:Plasma-lamp_2.jpg** *Source:* http://upload.wikimedia.org/wikipedia/commons/2/26/Plasma-lamp_2.jpg *License:* CC-BY-SA-3.0 *Contributors:*
- own work www.lucnix.be *Original artist:* Luc Viatour
- **File:Plasma_fountain.gif** *Source:* http://upload.wikimedia.org/wikipedia/commons/b/b9/Plasma_fountain.gif *License:* Public domain *Contributors:* Transferred from en.wikipedia; transfer was stated to be made by User:Nasib Bitar. *Original artist:* Original uploader was Iantresman at en.wikipedia
- **File:Plasma_jacobs_ladder.jpg** *Source:* http://upload.wikimedia.org/wikipedia/commons/4/40/Plasma_jacobs_ladder.jpg *License:* CC BY-SA 3.0 *Contributors:* Own work *Original artist:* Chocolateoak
- **File:Plasma_scaling.svg** *Source:* http://upload.wikimedia.org/wikipedia/commons/4/4c/Plasma_scaling.svg *License:* Public domain *Contributors:* Transferred from en.wikipedia to Commons. *Original artist:* Jafet.vixle at English Wikipedia
- **File:PnJunction-LED-E.svg** *Source:* <http://upload.wikimedia.org/wikipedia/commons/d/d7/PnJunction-LED-E.svg> *License:* CC BY-SA 2.5 *Contributors:* File:PnJunction-LED-E.PNG *Original artist:* User:S-kei
- **File:Polyphenylene_vinylene.png** *Source:* http://upload.wikimedia.org/wikipedia/commons/9/94/Polyphenylene_vinylene.png *License:* Public domain *Contributors:* ? *Original artist:* ?
- **File:Portal-puzzle.svg** *Source:* <http://upload.wikimedia.org/wikipedia/en/f/fd/Portal-puzzle.svg> *License:* Public domain *Contributors:* ? *Original artist:* ?
- **File:Pulsestarter.JPG** *Source:* <http://upload.wikimedia.org/wikipedia/commons/9/97/Pulsestarter.JPG> *License:* Public domain *Contributors:* Own work *Original artist:* ELIOT2000
- **File:QL_system_components.svg** *Source:* http://upload.wikimedia.org/wikipedia/commons/b/bb/QL_system_components.svg *License:* GFDL *Contributors:* `` *Original artist:* Fred the Oyster
- **File:Question_book-new.svg** *Source:* http://upload.wikimedia.org/wikipedia/en/9/99/Question_book-new.svg *License:* Cc-by-sa-3.0 *Contributors:*
Created from scratch in Adobe Illustrator. Based on Image:Question book.png created by User:Equazcion *Original artist:* Tkgd2007
- **File:RGB_LED.jpg** *Source:* http://upload.wikimedia.org/wikipedia/commons/f/f1/RGB_LED.jpg *License:* CC BY-SA 2.0 *Contributors:* RGB LED - RGBL-01-05 *Original artist:* oomlout
- **File:RGB_Light-emitting_diode.png** *Source:* http://upload.wikimedia.org/wikipedia/en/9/9a/RGB_Light-emitting_diode.png *License:* CC-BY-SA-3.0 *Contributors:*
Cell phone camera
Previously published: None
Original artist:
Wyn.junior
- **File:Red-YellowGreen-Blue_LED_spectra.png** *Source:* http://upload.wikimedia.org/wikipedia/commons/f/f4/Red-YellowGreen-Blue_LED_spectra.png *License:* CC-BY-SA-3.0 *Contributors:* Transferred from en.wikipedia to Commons by llans12. *Original artist:* Remember the dot at English Wikipedia
- **File:Red_and_green_traffic_signals_Stamford_Road_Singapore_-_20111210.jpg** *Source:* http://upload.wikimedia.org/wikipedia/commons/3/3c/Red_and_green_traffic_signals%2C_Stamford_Road%2C_Singapore_-_20111210.jpg *License:* CC BY-SA 3.0 *Contributors:* Own work, based on "File:Green traffic signal, Stamford Road, Singapore - 20111210-03.jpg" and "File:Red traffic signal, Stamford Road, Singapore - 20111210-01.jpg". *Original artist:* Smuconlaw; original photographs by Jacklee.
- **File:SON-T-Master-600W.jpg** *Source:* <http://upload.wikimedia.org/wikipedia/commons/4/47/SON-T-Master-600W.jpg> *License:* CC BY 3.0 *Contributors:* Own work *Original artist:* Skatebiker
- **File:SON-T_Master_600W.jpg** *Source:* http://upload.wikimedia.org/wikipedia/commons/9/91/SON-T_Master_600W.jpg *License:* Public domain *Contributors:* Own work *Original artist:* Skatebiker
- **File:SOX.png** *Source:* <http://upload.wikimedia.org/wikipedia/commons/3/3f/SOX.png> *License:* CC-BY-SA-3.0 *Contributors:* Transferred from nl.wikipedia to Commons. *Original artist:* The original uploader was Gerben49 at Dutch Wikipedia
- **File:Samsung_Galaxy_S_II_in_hand.jpg** *Source:* http://upload.wikimedia.org/wikipedia/commons/5/5d/Samsung_Galaxy_S_II_in_hand.jpg *License:* CC0 *Contributors:* Own work *Original artist:* Philip Jägenstedt
- **File:Sct_Mathias_xmas_illumination_2010-12-14.jpg** *Source:* http://upload.wikimedia.org/wikipedia/commons/5/58/Sct_Mathias_xmas_illumination_2010-12-14.jpg *License:* CC BY-SA 3.0 *Contributors:* Own work *Original artist:* Kim Hansen
- **File:Semi_resonant_start_circuit.png** *Source:* http://upload.wikimedia.org/wikipedia/commons/8/8e/Semi_resonant_start_circuit.png *License:* Public domain *Contributors:* Thorn Electrical Industries 1972 lighting catalogue *Original artist:* Thorn Electrical Industries, Limited
- **File:SiC_LED_historic.jpg** *Source:* http://upload.wikimedia.org/wikipedia/commons/6/64/SiC_LED_historic.jpg *License:* CC BY-SA 3.0 *Contributors:* Own work *Original artist:* Biolippi

- **File:Simple_representation_of_a_discharge_tube_-_plasma.png** *Source:* http://upload.wikimedia.org/wikipedia/commons/3/3e/Simple_representation_of_a_discharge_tube_-_plasma.png *License:* CC BY-SA 3.0 *Contributors:* Own work *Original artist:* Rudolfensis
- **File:Single_and_multicolor_surface_mount_miniature_LEDs_in_most_common_sizes.jpg** *Source:* http://upload.wikimedia.org/wikipedia/commons/3/3e/Single_and_multicolor_surface_mount_miniature_LEDs_in_most_common_sizes.jpg *License:* CC BY-SA 4.0 *Contributors:* Own work *Original artist:* Volkan Yuksel
- **File:Skybeamer-uniqema-640.jpg** *Source:* <http://upload.wikimedia.org/wikipedia/en/2/22/Skybeamer-uniqema-640.jpg> *License:* Cc-by-sa-3.0 *Contributors:* ? *Original artist:* ?
- **File:Smartphone.jpg** *Source:* <http://upload.wikimedia.org/wikipedia/en/8/87/Smartphone.jpg> *License:* CC-BY-SA-3.0 *Contributors:* Own work
Original artist: 
- **File:Sodium-glow.jpg** *Source:* <http://upload.wikimedia.org/wikipedia/commons/7/7d/Sodium-glow.jpg> *License:* CC BY 3.0 *Contributors:* <http://images-of-elements.com/sodium.php> *Original artist:* Jurii
- **File:Sodium_Spectra.jpg** *Source:* http://upload.wikimedia.org/wikipedia/commons/0/0b/Sodium_Spectra.jpg *License:* Public domain *Contributors:* Transferred from en.wikipedia
Original artist: (teravolt (talk)). Original uploader was Teravolt at en.wikipedia
- **File:Sodiumlamp.jpg** *Source:* <http://upload.wikimedia.org/wikipedia/commons/5/5b/Sodiumlamp.jpg> *License:* CC0 *Contributors:* Own work *Original artist:* Anonimski
- **File:Sony_oled.jpg** *Source:* http://upload.wikimedia.org/wikipedia/commons/6/60/Sony_oled.jpg *License:* CC BY-SA 2.0 *Contributors:* <http://www.flickr.com/photos/steveliao/2089119570/> *Original artist:* Steve Liao
- **File:Space_Shuttle_Atlantis_in_the_sky_on_July_21,_2011,_to_its_final_landing.jpg** *Source:* http://upload.wikimedia.org/wikipedia/commons/e/e0/Space_Shuttle_Atlantis_in_the_sky_on_July_21%2C_2011%2C_to_its_final_landing.jpg *License:* Public domain *Contributors:* <http://earthobservatory.nasa.gov/IOTD/view.php?id=51486> (direct link) *Original artist:* NASA/ISS Expedition 28
- **File:Spectra-Philips_32T8_natural_sunshine_fluorescent_light.svg** *Source:* http://upload.wikimedia.org/wikipedia/commons/7/78/Spectra-Philips_32T8_natural_sunshine_fluorescent_light.svg *License:* CC BY-SA 3.0 *Contributors:* Own work *Original artist:* RicHard-59
- **File:Spectral_Power_Distributions.png** *Source:* http://upload.wikimedia.org/wikipedia/commons/b/b0/Spectral_Power_Distributions.png *License:* CC-BY-SA-3.0 *Contributors:* ? *Original artist:* ?
- **File:Spectrum-hp-sodium.jpg** *Source:* <http://upload.wikimedia.org/wikipedia/commons/c/ca/Spectrum-hp-sodium.jpg> *License:* CC-BY-SA-3.0 *Contributors:* ?
- Transferred from en.wikipedia; Transfer was stated to be made by User:sevela.p. *Original artist:* Original uploader was Skatebiker at en.wikipedia
- **File:Spectrum_of_halophosphate_type_fluorescent_bulb_(f30t12_ww_rs).png** *Source:* http://upload.wikimedia.org/wikipedia/en/7/74/Spectrum_of_halophosphate_type_fluorescent_bulb_%28f30t12_ww_rs%29.png *License:* Cc-by-sa-3.0 *Contributors:* ? *Original artist:* ?
- **File:Staite-Petrie_Lamp_1847.png** *Source:* http://upload.wikimedia.org/wikipedia/commons/6/6c/Staite-Petrie_Lamp_1847.png *License:* Public domain *Contributors:* ? *Original artist:* ?
- **File:Starterp.jpg** *Source:* <http://upload.wikimedia.org/wikipedia/commons/4/4e/Starterp.jpg> *License:* CC BY-SA 2.5 *Contributors:* ? *Original artist:* ?
- **File:Stylised_Lithium_Atom.svg** *Source:* http://upload.wikimedia.org/wikipedia/commons/e/e1/Stylised_Lithium_Atom.svg *License:* CC-BY-SA-3.0 *Contributors:* based off of Image:Stylised Lithium Atom.png by Halfdan. *Original artist:* SVG by Indolences. Recoloring and ironing out some glitches done by Rainer Klute.
- **File:Symbol_list_class.svg** *Source:* http://upload.wikimedia.org/wikipedia/en/d/db/Symbol_list_class.svg *License:* Public domain *Contributors:* ? *Original artist:* ?
- **File:TCS_lamps2.jpg** *Source:* http://upload.wikimedia.org/wikipedia/commons/3/3a/TCS_lamps2.jpg *License:* CC BY 3.0 *Contributors:* Own work *Original artist:* Sympis
- **File:TI-30-LED-Display-3682e1.jpg** *Source:* <http://upload.wikimedia.org/wikipedia/commons/8/84/TI-30-LED-Display-3682e1.jpg> *License:* CC BY-SA 3.0 *Contributors:* Own work *Original artist:* Loadmaster (David R. Tribble)
- **File:Tanninglamp.jpg** *Source:* <http://upload.wikimedia.org/wikipedia/en/f/fb/Tanninglamp.jpg> *License:* PD *Contributors:* ? *Original artist:* ?
- **File:Tanninglampend.jpg** *Source:* <http://upload.wikimedia.org/wikipedia/en/1/16/Tanninglampend.jpg> *License:* CC-BY-3.0 *Contributors:* self-made
Original artist: Dennis Brown
- **File:Tantalum_light_bulb.png** *Source:* http://upload.wikimedia.org/wikipedia/commons/0/00/Tantalum_light_bulb.png *License:* Public domain *Contributors:* Downloaded August 18, 2013 from <a data-x-rel='nofollow' class='external text' href='http://books.google.com/books?id=PBsAAAAAAMAAJ,&,&,pg=RA1-PA238'>Oliver F. Brastow (April 1908) "The Tantalum Lamp: The salvation of overloaded systems", *Journal of the AIEE*, American Institute of Electrical Engineers, New York, Vol 10, No. 5, p. 238, fig. 1 on Google Books *Original artist:* Oliver F. Brastow
- **File:Thermal_image_of_an_incandescent_light.jpg** *Source:* http://upload.wikimedia.org/wikipedia/commons/5/58/Thermal_image_of_an_incandescent_light.jpg *License:* CC0 *Contributors:* Own work *Original artist:* Zaereth

- **File:Thermionic_filament.jpg** *Source:* http://upload.wikimedia.org/wikipedia/commons/d/dc/Thermionic_filament.jpg *License:* CC-BY-SA-3.0 *Contributors:* en.wikipedia.org *Original artist:* Created by Deglr6328, uploaded by Superclemente
- **File:Thomas_edison_glühbirne.jpg** *Source:* http://upload.wikimedia.org/wikipedia/commons/5/52/Thomas_edison_gl%C3%BChbirne.jpg *License:* Public domain *Contributors:* http://www.archives.gov/exhibits/american_originals_iv/sections/thomas_edison_patent.html *Original artist:* Unknown
- **File:Townsend_Discharge.svg** *Source:* http://upload.wikimedia.org/wikipedia/commons/7/7f/Townsend_Discharge.svg *License:* CC BY-SA 3.0 *Contributors:* Own work *Original artist:* Denis Fadeev
- **File:Tungstram_1904.PNG** *Source:* http://upload.wikimedia.org/wikipedia/commons/4/4d/Tungstram_1904.PNG *License:* CC BY-SA 3.0 *Contributors:* Own work ?? *Original artist:* Tungstram factory 1904 1909 or later
- **File:TungstenFilamentHalogenH1Lamp.JPG** *Source:* <http://upload.wikimedia.org/wikipedia/commons/8/82/TungstenFilamentHalogenH1Lamp.JPG> *License:* CC BY-SA 3.0 *Contributors:* Own work *Original artist:* Rolf Süßbrich
- **File:Tungsten_filament_in_halogen_lamp.JPG** *Source:* http://upload.wikimedia.org/wikipedia/commons/2/25/Tungsten_filament_in_halogen_lamp.JPG *License:* CC BY-SA 2.5 *Contributors:* Own work *Original artist:* w>User:Planemad
- **File:Various_lighting_spectrums_-_Fluorescent_incandescent_diode_and_candle.jpg** *Source:* http://upload.wikimedia.org/wikipedia/commons/e/e0/Various_lighting_spectrums_-_Fluorescent_incandescent_diode_and_candle.jpg *License:* CC BY-SA 4.0 *Contributors:* Own work *Original artist:* Zaereth
- **File:Verschiedene_LEDs.jpg** *Source:* http://upload.wikimedia.org/wikipedia/commons/9/9e/Verschiedene_LEDs.jpg *License:* CC BY-SA 2.0 *Contributors:* Own work *Original artist:* Afrank99
- **File:Very_small_1.6x1.6x0.35_mm_RGB_Surface_Mount_LED_EAST1616RGBA2.jpg** *Source:* http://upload.wikimedia.org/wikipedia/commons/f/fe/Very_small_1.6x1.6x0.35_mm_RGB_Surface_Mount_LED_EAST1616RGBA2.jpg *License:* CC BY-SA 4.0 *Contributors:* Own work *Original artist:* Volkan Yuksel
- **File:White_LED.png** *Source:* http://upload.wikimedia.org/wikipedia/commons/4/48/White_LED.png *License:* CC-BY-SA-3.0 *Contributors:* Originally from en.wikipedia; description page is/was here. *Original artist:* Original uploader was Deglr6328 at en.wikipedia
- **File:Wikibooks-logo.svg** *Source:* <http://upload.wikimedia.org/wikipedia/commons/f/fa/Wikibooks-logo.svg> *License:* CC BY-SA 3.0 *Contributors:* Own work *Original artist:* User:Bastique, User:Ramac et al.
- **File:Wikidata-logo.svg** *Source:* <http://upload.wikimedia.org/wikipedia/commons/f/ff/Wikidata-logo.svg> *License:* Public domain *Contributors:* Own work *Original artist:* User:Planemad
- **File:Wikinews-logo.svg** *Source:* <http://upload.wikimedia.org/wikipedia/commons/2/24/Wikinews-logo.svg> *License:* CC BY-SA 3.0 *Contributors:* This is a cropped version of Image:Wikinews-logo-en.png. *Original artist:* Vectorized by Simon 01:05, 2 August 2006 (UTC) Updated by Time3000 17 April 2007 to use official Wikinews colours and appear correctly on dark backgrounds. Originally uploaded by Simon.
- **File:Wikisource-logo.svg** *Source:* <http://upload.wikimedia.org/wikipedia/commons/4/4c/Wikisource-logo.svg> *License:* CC BY-SA 3.0 *Contributors:* Rei-artur *Original artist:* Nicholas Moreau
- **File:Wikiversity-logo-Snorky.svg** *Source:* <http://upload.wikimedia.org/wikipedia/commons/1/1b/Wikiversity-logo-en.svg> *License:* CC BY-SA 3.0 *Contributors:* Own work *Original artist:* Snorky
- **File:Wiktionary-logo-en.svg** *Source:* <http://upload.wikimedia.org/wikipedia/commons/f/f8/Wiktionary-logo-en.svg> *License:* Public domain *Contributors:* Vector version of Image:Wiktionary-logo-en.png. *Original artist:* Vectorized by Fvasconcellos (talk · contribs), based on original logo tossed together by Brion Vibber
- **File:Wolfram-Halogenglühlampe.png** *Source:* <http://upload.wikimedia.org/wikipedia/commons/4/49/Wolfram-Halogengl%C3%BChlampe.png> *License:* Public domain *Contributors:* ? *Original artist:* ?
- **File:Xenon_Flash_Wiki.ogv** *Source:* http://upload.wikimedia.org/wikipedia/commons/1/1b/Xenon_Flash_Wiki.ogv *License:* CC BY-SA 3.0 *Contributors:* Own work *Original artist:* Nathan Boor of Aimed Research
- **File:Xenon_Spectrum.jpg** *Source:* http://upload.wikimedia.org/wikipedia/commons/6/67/Xenon_Spectrum.jpg *License:* Public domain *Contributors:* Transferred from en.wikipedia; transferred to Commons by User:Homer Landskirty using CommonsHelper. *Original artist:* Teravolt (talk). Original uploader was Teravolt at en.wikipedia
- **File:Xenon_arc_lamp_profile.png** *Source:* http://upload.wikimedia.org/wikipedia/commons/1/11/Xenon_arc_lamp_profile.png *License:* Public domain *Contributors:* Own work *Original artist:* Sobarwiki
- **File:Xenon_discharge_tube.jpg** *Source:* http://upload.wikimedia.org/wikipedia/commons/d/d7/Xenon_discharge_tube.jpg *License:* FAL *Contributors:* Own work *Original artist:* Alchemist-hp (talk) (www.pse-mendeleejew.de)
- **File:Xenon_short_arc_1.jpg** *Source:* http://upload.wikimedia.org/wikipedia/commons/9/9e/Xenon_short_arc_1.jpg *License:* CC BY 2.5 *Contributors:* user-made *Original artist:* provided that proper attribution of my copyright is made. - Atlant 19:15, 26 August 2005 (UTC)
- **File:Xenon_short_arc_2.jpg** *Source:* http://upload.wikimedia.org/wikipedia/commons/a/a9/Xenon_short_arc_2.jpg *License:* CC BY 2.5 *Contributors:* ? *Original artist:* ?
- **File:Yellow_fluorescent_light_spectrum.png** *Source:* http://upload.wikimedia.org/wikipedia/commons/7/78/Yellow_fluorescent_light_spectrum.png *License:* CC-BY-SA-3.0 *Contributors:* Transferred from en.wikipedia; transfer was stated to be made by User:cephneiden. *Original artist:* Original uploader was Deglr6328 at en.wikipedia. Later version(s) were uploaded by Jmnbatista at en.wikipedia.
- **File:Светодиодный_светильник.jpg** *Source:* http://upload.wikimedia.org/wikipedia/commons/6/69/%D0%A1%D0%B2%D0%B5%D1%82%D0%BE%D0%B4%D0%B8%D0%BE%D0%B4%D0%BD%D1%8B%D0%B9_%D1%81%D0%B2%D0%B5%D1%82%D0%B8%D0%BB%D1%8C%D0%BD%D0%B8%D0%BA.jpg *License:* CC BY-SA 3.0 *Contributors:* Own work *Original artist:* Andrikus

27.3.3 Content license

- Creative Commons Attribution-Share Alike 3.0